

SDG7000A Series Arbitrary Waveform Generator

User Manual

EN01E



Copyright and Declaration

Copyright

SIGLENT TECHNOLOGIES CO., LTD. All Rights Reserved.

Trademark Information

SIGLENT is the registered trademark of **SIGLENT TECHNOLOGIES CO., LTD.**

Declaration

SIGLENT products are protected by patent law in and outside of P.R.C.

SIGLENT reserves the right to modify or change parts of or all the specifications or pricing policies at company's sole decision.

Information in this publication replaces all previously corresponding material.

Any way of copying, extracting or translating the contents of this manual is not allowed without the permission of **SIGLENT**.

Product Certification

SIGLENT guarantees this product conforms to the national and industrial stands in China and other international stands conformance certification is in progress.

CONTENT

1	INTRODUCTION	6
2	IMPORTANT SAFETY INFORMATION	7
2.1	GENERAL SAFETY SUMMARY	7
2.2	SAFETY TERMS AND SYMBOLS	9
2.3	WORKING ENVIRONMENT	9
2.4	COOLING REQUIREMENTS	11
2.5	POWER AND GROUNDING REQUIREMENTS	11
2.6	CLEANING	12
2.7	CALIBRATION	12
2.8	ABNORMAL CONDITIONS	12
2.9	SAFETY COMPLIANCE	13
	INFORMATIONS ESSENTIELLES SUR LA SÉCURITÉ	14
	EXIGENCE DE SÉCURITÉ	14
	TERMES ET SYMBOLES DE SÉCURITÉ	15
	ENVIRONNEMENT DE TRAVAIL	16
	EXIGENCES DE REFOIDISSEMENT	18
	CONNEXIONS D'ALIMENTATION ET DE TERRE	18
	NETTOYAGE	19
	CONDITIONS ANORMALES	19
	CONFORMITÉ EN MATIÈRE DE SÉCURITÉ	20
3	FIRST STEPS	21
3.1	DELIVERY CHECKLIST	21
3.2	QUALITY ASSURANCE	21
3.3	MAINTENANCE AGREEMENT	21
4	DOCUMENT CONVENTIONS	22
5	GETTING STARTED	23
5.1	POWER ON	23
5.2	POWER OFF	23
5.3	SYSTEM INFORMATION	23
5.4	INSTALL NEW OPTIONS	23
5.5	CHOOSING THE LANGUAGE	23
6	QUICK START	24
6.1	FRONT PANEL	24
6.2	REAR PANEL	25
6.3	CONNECTING TO EXTERNAL DEVICES/SYSTEMS	26
6.3.1	Power supply	26
6.3.2	Signal output	26
6.3.3	LAN	26
6.3.4	USB Peripherals	26
6.3.5	USB device interface	26

6.3.6	Reference clock input/output	26
6.3.7	Trigger in/Trigger out/Synchronous out	27
6.3.8	External modulation signal/counter input	27
6.3.9	Marker output	27
6.3.10	Digital signal output	27
7	TOUCH SCREEN DISPLAY	28
7.1	HOME PAGE	28
7.2	PARAMETER SETTING PAGE	29
7.3	DESCRIPTION OF ICONS IN THE STATUS BAR	30
7.4	GESTURE CONTROL	30
7.5	MOUSE OPERATION	30
8	FRONT PANEL	31
8.1	OVERVIEW	31
8.2	SHORTCUT BUTTONS	31
8.3	NUMERIC KEYPAD AND KNOB	32
8.4	CHANNEL SETTING BUTTONS	32
8.5	OTHER BUTTONS	32
9	BASIC WAVEFORM SETTING	33
9.1	STANDARD WAVEFORM SETTING	33
9.2	HARMONIC SETTING	39
9.3	NOISE SETTING	42
9.4	PRBS SETTING	44
9.5	ARBITRARY WAVEFORM SETTING	49
9.5.1	AFG Mode	49
9.5.2	AWG Mode	49
9.5.3	Data Source	51
9.5.4	Sequence Setting	58
9.6	I/Q SETTING	63
9.6.1	Working Mode	65
9.6.2	I/Q Adjustment	67
9.6.3	EasyIQ	67
10	MODULATION/SWEEP/BURST SETTINGS	70
10.1	OVERVIEW	70
10.2	MODULATION	71
10.2.1	Source Selection	72
10.2.2	Modulation Type	73
10.3	SWEEP	83
10.3.1	Sweep Type	84
10.3.2	Trigger Source	84
10.3.3	Sweep Parameter Settings	85
10.4	BURST	89
10.4.1	Burst type	89
10.4.2	Trigger Source	90
10.4.3	Burst Parameter Setting	90
11	DUAL CHANNEL SETUP	100
11.1	OVERVIEW	100
11.2	PHASE MODE	101

11.3	WAVEFORM COMBINE.....	103
11.4	CHANNEL TRACKING/COUPLING/COPY.....	104
12	OUTPUT SETTINGS	106
12.1	OVERVIEW	106
12.2	POLARITY.....	107
12.3	NOISESUM	108
12.4	AMPLITUDE LIMIT.....	108
12.5	DIGITAL FILTERING.....	109
12.6	OUTPUT PROTECTION.....	109
12.7	SINGLE-ENDED/DIFFERENTIAL SETTINGS	109
13	DIGITAL CHANNELS	112
13.1	OVERVIEW	112
13.2	DIGITAL CHANNEL SETTINGS	113
14	COUNTER	115
14.1	OVERVIEW	115
14.2	FREQUENCY METER MODE	115
14.3	TOTALIZER MODE	117
15	SAVE/RECALL	118
15.1	OVERVIEW	118
15.2	SAVE TYPE.....	118
15.3	RECALL TYPE.....	118
15.4	FILE MANAGER.....	120
15.5	SAVE AND RECALL INSTANCE.....	121
16	SYSTEM SETUP	123
16.1	GENERAL SETTINGS.....	123
16.1.1	<i>Language</i>	<i>123</i>
16.1.2	<i>Sound.....</i>	<i>123</i>
16.1.3	<i>Screen Saver</i>	<i>123</i>
16.1.4	<i>Keyboard Lock.....</i>	<i>124</i>
16.1.5	<i>Auto Power On.....</i>	<i>124</i>
16.1.6	<i>Date and Time</i>	<i>124</i>
16.2	SYSTEM INFORMATION.....	125
16.3	INTERFACE SETTINGS	125
16.3.1	<i>LAN Settings</i>	<i>125</i>
16.3.2	<i>Sync Output Settings</i>	<i>127</i>
16.3.3	<i>Multi-Device Synchronization.....</i>	<i>129</i>
16.4	TEST/CAL.....	130
16.4.1	<i>Perform Self-Test.....</i>	<i>130</i>
16.4.2	<i>Perform Self-Calibration.....</i>	<i>133</i>
16.4.3	<i>Time Base Calibration.....</i>	<i>133</i>
16.4.4	<i>Loading Factory Calibration Data</i>	<i>134</i>
16.5	PRE-SETTING.....	134
16.6	UPGRADE SOFTWARE	135
16.7	INSTALLATION OPTIONS	136

16.8 HELP	136
17 REMOTE CONTROL.....	137
17.1 WEB BROWSER	137
17.2 OTHER CONNECTIONS.....	138
18 TROUBLE SHOOTING	139

1 Introduction

This user manual includes important safety and installation information related to the SDG7000A series of arbitrary waveform generator and includes simple tutorials for basic operation of the instrument.

The series includes the following models:

Model	Analogy Bandwidth	Maximum Sample Rate	Analog Channel
SDG7102A	1 GHz	5 GSa/s	2
SDG7052A	500 MHz	5 GSa/s	2
SDG7032A	350 MHz	5 GSa/s	2

2 Important Safety Information

This manual contains information and warnings that must be followed by the user for safe operation and to keep the product in a safe condition.

2.1 General Safety Summary

Carefully read the following safety precautions to avoid personal injury and prevent damage to the instrument and any products connected to it. To avoid potential hazards, please use the instrument as specified.

To Avoid Fire or Personal Injure.

Use Proper Power Line.

Use only the special power line approved by the state and local authorities.

Ground the Instrument.

The instrument grounds through the protective terra conductor of the power line. To avoid electric shock, the ground conductor must be connected to the earth. Make sure the instrument is grounded correctly before connecting its input or output terminals.

Connect the Signal Wire Correctly.

The potential of the signal wire is equal to the earth, so do not connect the signal wire to a high voltage. Do not touch the exposed contacts or components.

Look over All Terminals Ratings.

To avoid fire or electric shock, please look over all ratings and signed instructions of the instrument. Before connecting the instrument, please read the manual carefully to gain more information about the ratings.

Equipment Maintenance and Service.

In the event of a device failure, please do not dismantle the machine for maintenance. The device contains capacitors, power supply, transformers and other energy storage devices which may cause high voltage damage. The internal devices of the device are sensitive to static electricity and direct contact can easily cause irreparable damage to the device. It is necessary to return to the factory or to the company's designated maintenance organization for maintenance. Be sure to pull out the power cord before repairing the device. Live line operation is strictly prohibited. The device can only be powered on when the maintenance is completed and the maintenance is confirmed to be successful.

Identification of Normal State of Equipment.

After the device is started, there will be no alarm information and error information at the interface under normal conditions. The curve of the interface will scan from left to right freely; if there is a button, alarm or error prompt, the device may be in an abnormal state. You need to view the specific prompt information. You can try to restart the setting. If the fault information is still in place, do not use it for testing. Contact the manufacturer or the maintenance department designated by the manufacturer to carry out maintenance to avoid the wrong test data caused by the use of the fault or endanger the personal safety.

Do Not Operate With Suspected Failures.

If you suspect that there is damage to the instrument, please let only qualified service personnel check it.

Avoid Exposed Circuits, Wire, or Components.

Do not touch exposed contacts or components when the power is on.

Do not operate in wet/damp conditions.

Do not operate in an explosive atmosphere.

Keep the surface of the instrument clean and dry.







Only lithium batteries with the same specification could be used to replace the battery on the main-board.

The responsible body or operator should refer to the instruction manual to preserve the protection afforded by the device. If the device is used in a manner not specified by the manufacturer, the protection provided by the device may be impaired.

Any parts of the device and its accessories are not allowed to be changed or replaced, other than authorized by the manufacturer or agent.

2.2 Safety Terms and Symbols

When the following symbols or terms appear on the front or rear panel of the instrument or in this manual, they indicate special care in terms of safety.

	This symbol is used where caution is required. Refer to the accompanying information or documents to protect against personal injury or damage to the instrument.
	This symbol warns of a potential risk of shock hazard.
	This symbol is used to denote the measurement ground connection.
	This symbol is used to denote a safety ground connection.
	This symbol shows that the switch is an On/Standby switch. When it is pressed, the instrument's state switches between Operation and Standby. This switch does not disconnect the device's power supply. To completely power off the instrument, the power cord must be unplugged from the AC socket after the instrument is in the standby state.
	This symbol is used to represent alternating current, or "AC".
CAUTION	The " CAUTION " symbol indicates a potential hazard. It calls attention to a procedure, practice, or condition which may be dangerous if not followed. Do not proceed until its conditions are fully understood and met.
WARNING	The " WARNING " symbol indicates a potential hazard. It calls attention to a procedure, practice, or condition which, if not followed, could cause bodily injury or death. If a WARNING is indicated, do not proceed until the safety conditions are fully understood and met.

2.3 Working Environment

The design of the instrument has been verified to conform to EN 61010-1 safety standard per the following limits:

Environment

The instrument is used indoors and should be operated in a clean and dry environment with an ambient temperature range.

Note: Direct sunlight, electric heaters, and other heat sources should be considered when evaluating the ambient temperature.



Warning: Do not operate the instrument in explosive, dusty, or humid environments.

Ambient Temperature

Operating: 0 °C to +50 °C

Non-operation: -20 °C to +60 °C

Note: Direct sunlight, radiators, and other heat sources should be taken into account when assessing the ambient temperature.

Humidity

Operating: 5% ~ 90 %RH, 30 °C, derate to 50 %RH at 50 °C

Non-operating: 5% ~ 95% RH

Altitude

Operating: ≤ 3,048 m, 25 °C

Non-operating: ≤ 12,192 m

Installation (overvoltage) Category

This product is powered by mains conforming to installation (overvoltage) Category II.

Note: Installation (overvoltage) category I refers to situations where device measurement terminals are connected to the source circuit. In these terminals, precautions are done to limit the transient voltage to a correspondingly low level.

Installation (overvoltage) category II refers to the local power distribution level which applies to devices connected to the AC line (AC power).

Degree of Pollution

The Instrument may be operated in environments of Pollution Degree II.

Note: Degree of Pollution II refers to a working environment that is dry and non-conductive pollution occurs. Occasional temporary conductivity caused by condensation is expected.

IP Rating

IP20 (as defined in IEC 60529).

2.4 Cooling Requirements

This instrument relies on forced air cooling with internal fans and ventilation openings. Care must be taken to avoid restricting the airflow around the apertures (fan holes) at each side of the instrument. To ensure adequate ventilation it is required to leave a 15 cm (6 inch) minimum gap around the sides of the instrument.



CAUTION: Do not block the ventilation holes located on both sides of the instrument.



CAUTION: Do not allow any foreign matter to enter the instrument through the ventilation holes, etc.

2.5 Power and Grounding Requirements

The instrument operates with a single-phase, 100 to 240 Vrms (+/- 10%) AC power at 50/60 Hz (+/- 5%).

No manual voltage selection is required because the instrument automatically adapts to line voltage.

Depending on the type and number of options and accessories (PC port plug-in, etc.), the instrument can consume up to 110 W of power.

Note: The instrument automatically adapts to the AC line input within the following ranges:

Voltage Range:	90 - 264 Vrms
Frequency Range:	47 - 63 Hz

The instrument includes a grounded cord set containing a molded three-terminal polarized plug and a standard IEC320 (Type C13) connector for making line voltage and safety ground connection. The AC inlet ground terminal is connected directly to the frame of the instrument. For adequate protection against electrical shock hazards, the power cord plug must be inserted into a mating AC outlet containing a safety ground contact. Use only the power cord specified for this instrument and certified for the country of use.



Warning: Electrical Shock Hazard!

Any interruption of the protective conductor inside or outside of the instrument, or disconnection of the safety ground terminal creates a hazardous situation.

Intentional interruption is prohibited.

The position of the instrument should allow easy access to the socket. To make the instrument completely power off, unplug the instrument power cord from the AC socket.

The power cord should be unplugged from the AC outlet if the instrument is not to be used for an extended period.

	CAUTION: The outer shells of the front panel terminals (CH1, CH2) are connected to the instrument's chassis and therefore to the safety ground.
---	--

2.6 Cleaning

Clean only the exterior of the instrument, using a damp, soft cloth. Do not use chemicals or abrasive elements. Under no circumstances allow moisture to penetrate the instrument. To avoid electrical shock, unplug the power cord from the AC outlet before cleaning.

	Warning: Electrical Shock Hazard! No operator serviceable parts inside. Do not remove covers. Refer servicing to qualified personnel
---	---

2.7 Calibration

The recommended calibration period is one year. Calibration should only be carried out by qualified personnel.

2.8 Abnormal Conditions

Do not operate the instrument if there is any visible sign of damage or has been subjected to severe transport stresses.

If you suspect the instrument's protection has been impaired, disconnect the power cord and secure the instrument against any unintended operation.

Proper use of the instrument depends on careful reading of all instructions and labels.

	Warning: Any use of the instrument in a manner not specified by the manufacturer may impair the instrument's safety protection. This instrument should not be directly connected to human subjects or used for patient monitoring.
---	---

2.9 Safety Compliance

This section lists the safety standards with which the product complies.

U.S. nationally recognized testing laboratory listing

- UL 61010-1:2012/R: 2018-11. Safety Requirements for Electrical Equipment for Measurement, Control, and Laboratory Use – Part 1: General Requirements.

Canadian certification

CAN/CSA-C22.2 No. 61010-1:2012/A1:2018-11. Safety Requirements for Electrical Equipment for Measurement, Control, and Laboratory Use – Part 1: General Requirements.

Informations essentielles sur la sécurité

Ce manuel contient des informations et des avertissements que les utilisateurs doivent suivre pour assurer la sécurité des opérations et maintenir les produits en sécurité.

Exigence de Sécurité

Lisez attentivement les précautions de sécurité ci - après afin d'éviter les dommages corporels et de prévenir les dommages aux instruments et aux produits associés. Pour éviter les risques potentiels, utilisez les instruments prescrits.

Éviter l'incendie ou les lésions corporelles.

Utilisez un cordon d'alimentation approprié.

N'utilisez que des cordons d'alimentation spécifiques aux instruments approuvés par les autorités locales.

Mettez l'instrument au sol.

L'instrument est mis à la Terre par un conducteur de mise à la terre de protection du cordon d'alimentation. Pour éviter un choc électrique, le conducteur de mise à la terre doit être mis à la terre. Assurez - vous que l'instrument est correctement mis à la terre avant de connecter les bornes d'entrée ou de sortie de l'instrument.

Connectez correctement le fil de signalisation.

Le potentiel de la ligne de signal est égal au potentiel au sol, donc ne connectez pas la ligne de signal à haute tension. Ne touchez pas les contacts ou les composants exposés.

Voir les cotes de tous les terminaux.

Pour éviter un incendie ou un choc électrique, vérifiez toutes les cotes et signez les instructions de l'instrument. Avant de brancher l'instrument, lisez attentivement ce manuel pour obtenir de plus amples renseignements sur les cotes.

Entretien du matériel.

En cas de défaillance de l'équipement, ne pas démonter et entretenir l'équipement sans autorisation. L'équipement contient des condensateurs, de l'alimentation électrique, des transformateurs et d'autres dispositifs de stockage d'énergie, ce qui peut causer des blessures à haute tension. Les dispositifs internes de l'équipement sont sensibles à l'électricité statique. Le contact direct peut facilement causer des blessures irréversibles à l'équipement. L'équipement doit être retourné à l'usine ou à l'organisme de maintenance désigné par l'entreprise pour l'entretien. L'alimentation électrique doit être retirée pendant l'entretien. La ligne ne doit pas être mise sous tension tant que l'entretien de l'équipement n'est pas terminé et que l'entretien n'est pas confirmé.

Identification de l'état normal de l'équipement.

Après le démarrage de l'équipement, dans des conditions normales, il n'y aura pas d'information d'alarme et d'erreur au bas de l'interface, et la courbe de l'interface sera balayée librement de gauche à droite; si un blocage se produit pendant le processus de numérisation, ou si l'information d'alarme ou d'erreur apparaît au bas de l'interface, l'équipement peut être dans un état anormal. Pour voir l'information d'alarme spécifique, vous pouvez d'abord essayer de redémarrer. Si l'information sur la défaillance est toujours présente, ne l'utilisez pas pour l'essai. Contactez le fabricant ou le Service de réparation désigné par le fabricant pour effectuer l'entretien afin d'éviter d'apporter des données d'essai erronées ou de mettre en danger la sécurité personnelle en raison de l'utilisation de la défaillance.

Ne pas fonctionner en cas de suspicion de défaillance.

Si vous soupçonnez des dommages à l'instrument, demandez à un technicien qualifié de vérifier.

L'exposition du circuit ou de l'élément d'exposition du fil est évitée.

Lorsque l'alimentation est connectée, aucun contact ou élément nu n'est mis en contact.

Ne pas fonctionner dans des conditions humides / humides.**Pas dans un environnement explosif.****Maintenez la surface de l'instrument propre et sec.**







L'organisme ou l'opérateur responsable doit se référer au cahier des charges pour protéger la protection offerte par le matériel. La protection offerte par le matériel peut être compromise si celui-ci est utilisé de manière non spécifiée par le fabricant.

Aucune pièce du matériel et de ses annexes ne peut être remplacée ou remplacée sans l'autorisation de son fabricant.

Remplacer la batterie dans l'appareil avec les mêmes spécifications de batterie au lithium.

Termes et symboles de sécurité

Lorsque les symboles ou termes suivants apparaissent sur le panneau avant ou arrière de l'instrument ou dans ce manuel, ils indiquent un soin particulier en termes de sécurité.

	Ce symbole est utilisé lorsque la prudence est requise. Reportez-vous aux informations ou documents joints afin de vous protéger contre les blessures ou les dommages à l'instrument.
	Ce symbole avertit d'un risque potentiel de choc électrique.
	Ce symbole est utilisé pour désigner la connexion de terre de mesure.
	Ce symbole est utilisé pour indiquer une connexion à la terre de sécurité.
	Ce symbole indique que l'interrupteur est un interrupteur marche / veille. Lorsqu'il est enfoncé, l'état de l'instrument bascule entre Fonctionnement et Veille. Ce commutateur ne déconnecte pas l'alimentation de l'appareil. Pour éteindre complètement l'instrument, le cordon d'alimentation doit être débranché de la prise secteur une fois l'instrument en état de veille.
	Ce symbole est utilisé pour représenter un courant alternatif, ou "AC".
CAUTION	Le symbole " CAUTION " indique un danger potentiel. Il attire l'attention sur une procédure, une pratique ou une condition qui peut être dangereuse si elle n'est pas suivie. Ne continuez pas tant que ses conditions n'ont pas été entièrement comprises et remplies.
WARNING	Le symbole " WARNING " indique un danger potentiel. Il attire l'attention sur une procédure, une pratique ou une condition qui, si elle n'est pas suivie, pourrait entraîner des blessures corporelles ou la mort. Si un AVERTISSEMENT est indiqué, ne continuez pas tant que les conditions de sécurité ne sont pas entièrement comprises et remplies.

Environnement de travail

La conception de l'instrument a été certifiée conforme à la norme EN 61010-1, sur la base des valeurs limites suivantes:

Environnement

L'instrument doit être utilisé à l'intérieur dans un environnement propre et sec dans la plage de température ambiante.

Note: la lumière directe du soleil, les réchauffeurs électriques et d'autres sources de chaleur doivent être pris en considération lors de l'évaluation de la température ambiante.

	Attention: Ne pas utiliser l'instrument dans l'air explosif, poussiéreux ou humide.
---	--

Température ambiante

En fonctionnement: 0 °C à +50 °C

Hors fonctionnement: -20 °C à +60 °C

Note: pour évaluer la température de l'environnement, il convient de tenir compte des rayonnements solaires directs, des radiateurs thermiques et d'autres sources de chaleur.

Humidité

Fonctionnement: 5% ~ 90% HR, 30 °C, 40 °C réduit à 50% HR
Hors fonctionnement: 5% ~ 95%

Altitude

Fonctionnement: ≤ 3000 m

À l'arrêt: ≤ 12,191 m

Catégorie d'installation (surtension)

Ce produit est alimenté par une alimentation électrique conforme à l'installation (surtension) Catégorie II.

Installation (overvoltage) Category Definitions Définition de catégorie d'installation (surtension)

La catégorie II d'installation (surtension) est un niveau de signal applicable aux terminaux de mesure d'équipement reliés au circuit source. Dans ces bornes, des mesures préventives sont prises pour limiter la tension transitoire à un niveau inférieur correspondant.

La catégorie II d'installation (surtension) désigne le niveau local de distribution d'énergie d'un équipement conçu pour accéder à un circuit alternatif (alimentation alternative).

Degré de pollution

Un instrument peut être utilisé dans un environnement Pollution Degree II.

Note: Pollution Degree II signifie que le milieu de travail est sec et qu'il y a une pollution non conductrice. Parfois, la condensation produit une conductivité temporaire.

IP Rating

IP20 (as defined in IEC 60529).

Exigences de refroidissement

Cet instrument repose sur un refroidissement à air forcé avec des ventilateurs internes et des ouvertures de ventilation. Des précautions doivent être prises pour éviter de restreindre le flux d'air autour des ouvertures (trous de ventilateur) de chaque côté de la lunette. Pour assurer une ventilation adéquate, il est nécessaire de laisser un espace minimum de 15 cm (6 pouces) sur les côtés de l'instrument.



ATTENTION: Ne bloquez pas les trous de ventilation situés des deux côtés de la lunette.



ATTENTION: Ne laissez aucun corps étranger pénétrer dans la lunette par les trous de ventilation, etc.

Connexions d'alimentation et de terre

L'instrument fonctionne avec une alimentation CA monophasée de 100 à 240 Vrms (+/- 10%) à 50/60 Hz (+/- 5%).

Aucune sélection manuelle de la tension n'est requise car l'instrument s'adapte automatiquement à la tension de ligne.

Selon le type et le nombre d'options et d'accessoires (plug-in de port PC, etc.), l'instrument peut consommer jusqu'à 110 W d'énergie.

Remarque: l'instrument s'adapte automatiquement à l'entrée de ligne CA dans les plages suivantes:

Plage de tension:	90 - 264 Vrms
Gamme de fréquences:	47 - 63 Hz

L'instrument comprend un jeu de cordons mis à la terre contenant une fiche polarisée à trois bornes moulée et un connecteur standard IEC320 (Type C13) pour établir la tension de ligne et la connexion de mise à la terre de sécurité. La borne de mise à la terre de l'entrée CA est directement connectée au châssis de l'instrument. Pour une protection adéquate contre les risques d'électrocution, la fiche du cordon d'alimentation doit être insérée dans une prise secteur correspondante contenant un contact de sécurité avec la terre. Utilisez uniquement le cordon d'alimentation spécifié pour cet instrument et certifié pour le pays d'utilisation.



Avertissement: Risque de choc électrique!

Toute interruption du conducteur de terre de protection à l'intérieur ou à l'extérieur de la portée ou la déconnexion de la borne de terre de sécurité crée une situation dangereuse.

L'interruption intentionnelle est interdite.

La position de l'instrument doit permettre un accès facile à la prise. Pour éteindre complètement l'instrument, débranchez le cordon d'alimentation de l'instrument de la prise secteur.

Le cordon d'alimentation doit être débranché de la prise secteur si la lunette ne doit pas être utilisée pendant une période prolongée.



ATTENTION: les enveloppes extérieures des bornes du panneau avant (CH1, CH2) sont connectées au châssis de l'instrument et donc à la terre de sécurité.

Nettoyage

Nettoyez uniquement l'extérieur de l'instrument à l'aide d'un chiffon doux et humide. N'utilisez pas de produits chimiques ou d'éléments abrasifs. Ne laissez en aucun cas l'humidité pénétrer dans l'instrument. Pour éviter les chocs électriques, débranchez le cordon d'alimentation de la prise secteur avant de le nettoyer.



Avertissement: Risque de choc électrique!

Aucune pièce réparable par l'opérateur à l'intérieur. Ne retirez pas les capots.

Confiez l'entretien à un personnel qualifié

Conditions anormales

Utilisez l'instrument uniquement aux fins spécifiées par le fabricant.

N'utilisez pas la lunette s'il y a des signes visibles de dommages ou si elle a été soumise à de fortes contraintes de transport.

Si vous pensez que la protection de l'instrument a été altérée, débranchez le cordon d'alimentation et sécurisez l'instrument contre toute opération involontaire.

Une bonne utilisation de l'instrument nécessite la lecture et la compréhension de toutes les instructions et étiquettes.



Avertissement: Toute utilisation de l'instrument d'une manière non spécifiée par le fabricant peut compromettre la protection de sécurité de l'instrument. Cet instrument ne doit pas être directement connecté à des sujets humains ni utilisé pour la surveillance des patients.

Conformité en matière de sécurité

La présente section présente les normes de sécurité applicables aux produits.

U.S. nationally recognized testing laboratory listing

- UL 61010-1:2012/R:2018-11. Prescriptions en matière de sécurité pour les appareils électriques utilisés en laboratoire et de mesure - partie 1: prescriptions générales.

Canadian certification

- CAN/CSA-C22.2 No. 61010-1:2012/A1:2018-11. Prescriptions en matière de sécurité pour les appareils électriques utilisés en laboratoire et de mesure - partie 1: prescriptions générales.

3 First steps

3.1 Delivery Checklist

First, verify that all items listed on the packing list have been delivered. If you note any omissions or damage, please contact your nearest **SIGLENT** customer service center or distributor as soon as possible. If you fail to contact us immediately in case of omission or damage, we will not be responsible for replacement.

3.2 Quality Assurance

The instrument has a 3-year warranty (1-year warranty for probes and attachments) from the date of shipment, during normal use and operation. **SIGLENT** can repair or replace any product that is returned to the authorized service center during the warranty period. We must first examine the product to make sure that the defect is caused by the process or material, not by abuse, negligence, accident, abnormal conditions or operation.

SIGLENT shall not be responsible for any defect, damage, or failure caused by any of the following:

- a) Attempted repairs or installations by personnel other than **SIGLENT**.
- b) Connection to incompatible devices/incorrect connection.
- c) For any damage or malfunction caused by the use of non-**SIGLENT** supplies. Furthermore, **SIGLENT** shall not be obligated to service a product that has been modified. Spare, replacement parts and repairs have a 90-day warranty.

The instrument's firmware has been thoroughly tested and is presumed to be functional. Nevertheless, it is supplied without warranty of any kind covering detailed performance. Products not made by **SIGLENT** are covered solely by the warranty of the original device manufacturer.

3.3 Maintenance Agreement

We provide various services based on maintenance agreements. We offer extended warranties as well as installation, training, enhancement and on-site maintenance, and other services through specialized supplementary support agreements. For details, please consult your local **SIGLENT** customer service center or distributor.

4 Document Conventions

For convenience, text surrounded by a box border is used to represent the button of the front panel. For example, Enter represents the "Enter" button on the front panel. Italicized text with shading is used to represent the touchable or clickable menu/option/ Virtual key /button/ on the touch screen. For example, Load represents the "Load" option on the screen:

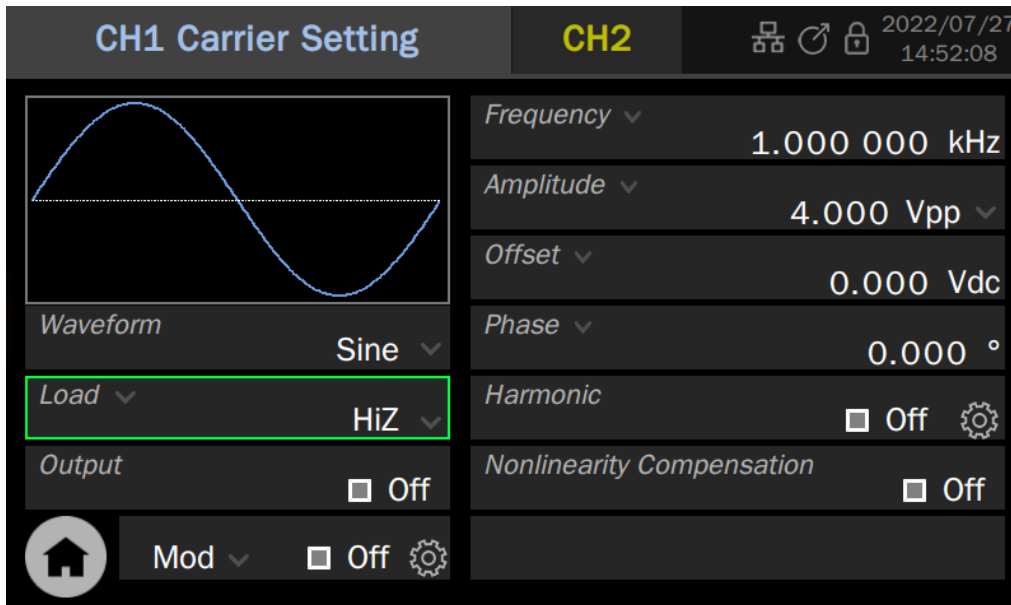

For the operations that contain multiple steps, the description is in the form of "Step 1 > Step 2 >..". As an example, follow each step in the sequence to enter the upgrade interface:

Home > Utility > Update

Press the Home button on the front panel as step 1, click the Utility option on the screen as step 2, and click the Update option on the screen as step 3 to enter the upgrade interface.

This user manual provides some application examples to facilitate users to quickly get familiar with the operation of the instrument. Each application instance is marked with an  icon.

The notes in this manual suggest some important information, and each note is marked with an  icon.

5 Getting Started

5.1 Power on

First, turn on the power switch under the AC socket on the rear panel, and then press the power button on the front panel to start the device. If it is set to "Auto Power-on", the device will automatically boot when the power is connected, as described in the 'Auto Power-' section.

5.2 Power off

Press and hold the power button on the front panel for two seconds to turn off the device, or turn it off through the following steps:

Utility > Shut Down .



The Power button does not disconnect the instrument from the AC power supply. The way to fully power down the instrument is to disconnect the AC power input by turning off the power switch under the AC socket on the rear panel or unplugging the AC power cord from the outlet.

5.3 System Information

Follow the steps below to examine the software and hardware versions of the device:

Utility > System Info

5.4 Install new Options

A license is necessary to unlock a software option. See the section "Installation options" for details.

5.5 Choosing the Language

Utility > Setting > Language .

6 Quick start

6.1 Front Panel



- A Touch Screen Display** The control and display center of the instrument. See "**Touch Screen Display**" for details.
- D CH2 Output** Same as CH1 except that when outputting baseband I / Q signal, CH2 is as "Q" signal.
- B Front Panel Keyboard** Includes knobs and keys, which are used to quickly call or set some common functions. See "**Front Panel**" for details.
- E USB 2.0 Hosts**
- C CH1 Output** When the output is differential, right is "+" and left is "-"; When the output is single-ended, it is output from the "+" port. When outputting baseband I / Q signal, CH1 is as "I" signal; When outputting IF (Intermediate Frequency) signal, CH1 is as the IF.
- F Power Button**

6.2 Rear panel



- | | |
|--|--|
| <p>A 10 MHz Reference Clock Output and Input</p> <p>B Trigger In/Trigger Out /Sync Out
When an internal trigger or manual trigger is used for frequency sweep, burst, and other functions, a trigger signal can be output from this port. When an external trigger is used, a trigger signal be applied to the port. It can also output a synchronization signal with the same signal frequency and input as an external modulation signal for ASK / FSK / PSK.</p> <p>C External Modulation Signal / Counter Input</p> <p>D Markers</p> | <p>E 16-bit Digital Bus Output</p> <p>F USB 2.0 Host</p> <p>G USB 2.0 Device</p> <p>H 10M/100M LAN</p> <p>I AC Power Input</p> <p>J Power Switch</p> <p>K Earth Terminal</p> <p>L OCXO (factory installed)</p> |
|--|--|

6.3 Connecting to External Devices/Systems

6.3.1 Power supply

The standard power supply for the instrument is 100~240 V, 50/60 Hz. Please use the power cord provided with the instrument to connect it to AC power.

6.3.2 Signal output

The 4 BNC terminals on the front panel are analog signal output ports.

The two left terminals are CH1 outputs, which can also be used as I outputs for baseband I/Q or IF (Intermediate Frequency) outputs. The two right terminals are CH2 outputs, which can also be used as Q outputs for baseband I/Q.

When the channel output is defined as differential, the right "+" and left "-" are used. When the channel output is defined as single-ended, it is output from the "+" terminal.



The CH1/CH2 outputs do not support a floating ground. Please ensure that the ground on the receiver side is of equal potential to the ground of this device.

6.3.3 LAN

Connect the LAN port on the rear panel to an active network with a standard Ethernet network cable terminated with an RJ45 connector.

Use a network cable to connect the LAN port on the rear panel of the unit to a network device. Follow the steps below to set LAN connection:

Utility > Interface > LAN Settings

For more information on LAN settings, please refer to the section "LAN Settings".

The instrument is integrated with WebSever and supports direct access control via a browser. See the section "Web Browser" for more information.

6.3.4 USB Peripherals

Connect a USB storage device (FAT32 format) to one of the USB host ports for data transfer, or connect USB mouse/keyboard to one of the USB host ports for controlling the instrument.

6.3.5 USB device interface

The instrument supports remote control by connecting the instrument to the host computer via the USB Device port. See the chapter "Remote control" for more information.

6.3.6 Reference clock input/output

When the instrument is using an external clock source, the 10 MHz reference clock is input from the 10MHz In port located on the rear panel. The 10 MHz Out port outputs a 10 MHz sine wave

reference clock, which is synchronized with the active clock source no matter what the clock source is.

The reference clock input/output terminals can be cascaded to synchronize multiple devices. For details, please refer to the section "Multi-Device Synchronization".

6.3.7 Trigger in/Trigger out/Synchronous out

When internal or manual trigger is used for a frequency sweep, burst or other functions, the trigger signal can be output from this port. When an external trigger is used, a trigger signal is delivered to the port. It can also be output as a synchronization signal with the same signal frequency. This enables synchronization with the modulating waveform when modulation is enabled and synchronization with the carrier when modulation is disabled.

6.3.8 External modulation signal/counter input

When modulation is on, the port is automatically switched to the external modulation input. When the frequency counter function is on, the port is automatically switched to the counter input, eliminating the need for manual switching by the user.

6.3.9 Marker output

The output is valid when the specified position of the arbitrary waveform or I / Q signal mark arrives, or when the specified frequency of the sweep signal arrives.

6.3.10 Digital signal output

The digital outputs are obtained by plugging in a matching Digital Bus Kit (LVDS or LVTTTL). The Digital Bus Kit for LVDS output is passive and requires no power supply. The Digital Bus Kit for LVTTTL output is active and requires a 5 V power supply from the USB Host to transfer signals' level from LVDS level to LVTTTL level.

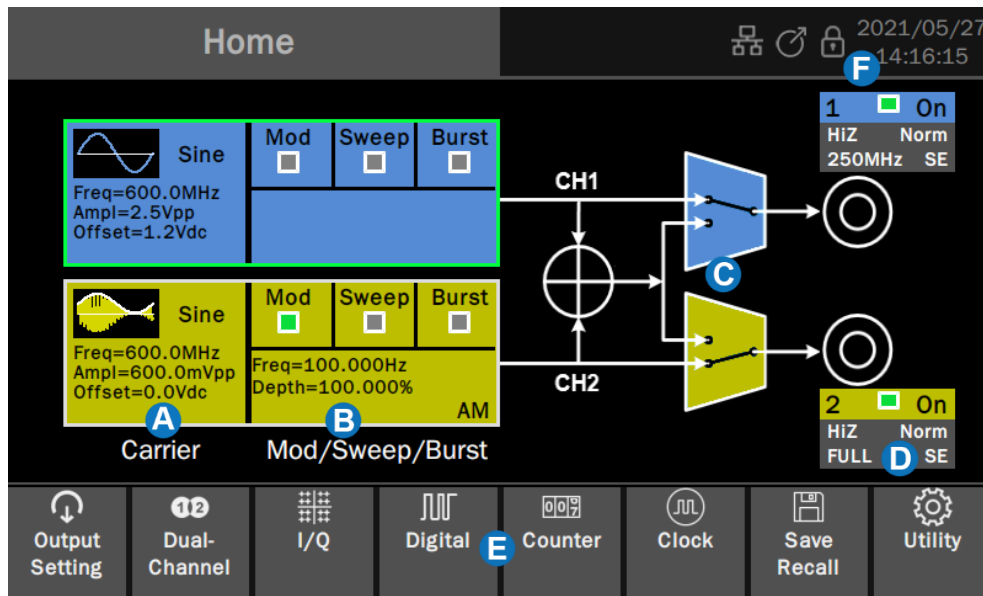

Figure 6-1: SDG7000A and Digital Logic Kit connected to an oscilloscope

7 Touch Screen Display

The entire display area of the device is a touch screen. You can use your fingers for touch control or use a mouse for operation. It is recommended that to use the mouse supplied with the unit since the display area is compact. All displays and controls can be accessed via the touch screen.

7.1 Home Page



- A Carrier Setting Boxes** set and display parameters of the carrier. Click to enter the carrier setting page
- B Modulation/Sweep/Burst Setting Boxes** set and display parameters of modulation/sweep/burst. Click to enter the modulation/sweep/burst setting page.
- C Waveform Combine Setting** provides a schematic diagram and settings for the channel combination function. Click the switches in the area to switch between channel output alone and channel output after combination.
- D Channel Output Setting Boxes** set and display output parameters. Click to switch between On/Off.
- D Toolbar** provides shortcuts to common functions.
- E Status Bar** displays information such as network connection status, clock status, phase mode, and time/date.

7.2 Parameter Setting Page

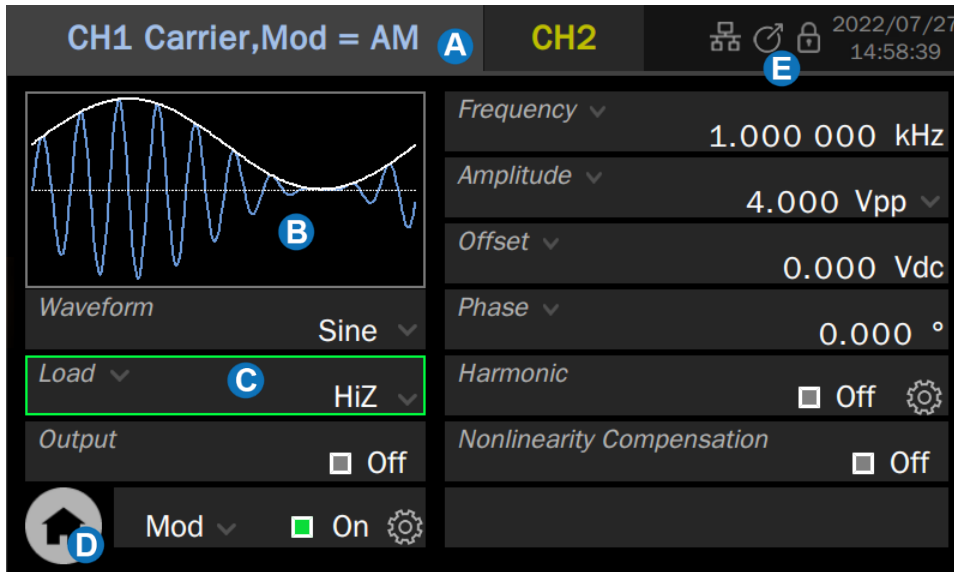

- A Channel Tab** Click the tab corresponding to the channel to switch to the parameter setting page of the channel.
- B Waveform Preview** Displays the preview of the waveform.
- C Parameter Setting Box** The parameter name is on the left. If the parameter name is followed by an icon , it indicates that the parameter has alternative parameters, such as "Frequency" can be switched to "Period". Click here to switch the parameter.

The parameter value is on the right. If the value has a unit, the unit will be displayed. Click the parameter value area to set the value by the virtual keyboard or front panel keyboard.

If the parameter value or unit is followed by an icon , it means that there are multiple options (for example, the unit of sine wave amplitude can be set to "Vpp", "Vrms" or "dBm"), click the icon to select.

If the parameter value area is a switch icon , it means that the parameter has only "ON" and "OFF" states. Click the icon to switch.

If the parameter value is followed by an icon , it indicates that there are more detailed parameter settings. Click the icon to enter the corresponding next level page.

- D Go to the Home Page**
- E Status Bar** Displays information such as network connection status, clock status, phase mode, and time/date.

7.3 Description of Icons in the Status Bar



The network is connected. Click this icon to quickly set the LAN.



No network connection. Click this icon to quickly set the LAN.



USB storage device detected.



The clock source is internal. Click this icon to quickly set the clock source.



The clock source is external. Click this icon to quickly set the clock source.



The clock source is external, but no valid external clock was detected. Click this icon to quickly set the clock source.



The phase mode is "Locked". Click this icon to quickly set the phase mode.



The phase mode is "Independent". Click this icon to quickly set the phase mode

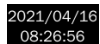

Time/date. Click this area to quickly set the time/date.

7.4 Gesture Control

The touch screen is capacitive. Operations are mainly done by a single touch.

7.5 Mouse operation

It is recommended to use a mouse for more accurate operations.

8 Front Panel

8.1 Overview



The SDG7000A Series Arbitrary Waveform Generator has integrated front panel buttons for frequently used functions, which can be used in conjunction with the touch screen for more efficient operation.

8.2 Shortcut Buttons



Press the **Burst** / **Mod** / **Sweep** button to quickly turn on/off the burst/modulation/sweep function and jump to the corresponding parameter setting page. When the function is turned on, the corresponding button light is on.

Press the **AWG** / **I/Q** button to quickly switch the waveform to arbitrarily waveform/vector signal and jump to the corresponding parameter setting page. When the waveform is selected, the corresponding button light is on.

Press the **Digital** button to quickly turn on / off the digital bus output and jump to the corresponding parameter setting page. When the digital bus is turned on, the corresponding button light is on.

Press the **Waveform** button to quickly recall the waveform selection menu. Press the **Utility** button to quickly recall the system setup menu.

8.3 Numeric Keypad and Knob



Use the numeric keypad to directly enter the value and order of magnitude of the selected parameter.

For example, to set the frequency to 1 GHz, press the keys **1** and **G/n** in turn. If the order of magnitude is 1 (100), you can press **Enter** directly.

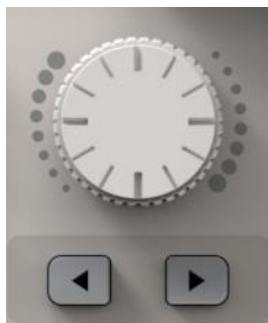

In addition to directly typing parameter values with the numeric keypad, you can also use the knob for continuous adjustment of parameters.

Press the knob on the selected parameter box and press the button **◀** and **▶** below the knob to select the digit to be adjusted, and then rotate the knob clockwise to increase the value or counterclockwise to decrease.

8.4 Channel Setting Buttons

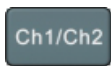

Press this button to quickly switch between CH1 and CH2 parameter setting pages.

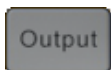

Press this button to switch the channel output on/off. When the channel is ON, the indicator light above the corresponding BNC connector lights up. Press this button for 2 seconds to switch the channel output load between 50Ω and high impedance.

8.5 Other Buttons

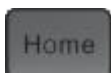

Press this button to go to the home page

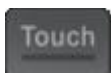

Press this button to turn the touch screen on/off. When the touch screen is enabled, the corresponding light is on

9 Basic Waveform Setting

9.1 Standard Waveform Setting

This section applies to sine, square, pulse, triangle, and DC waveform types. This section takes setting sine wave as an example to explain settings of basic parameters of a standard waveform.

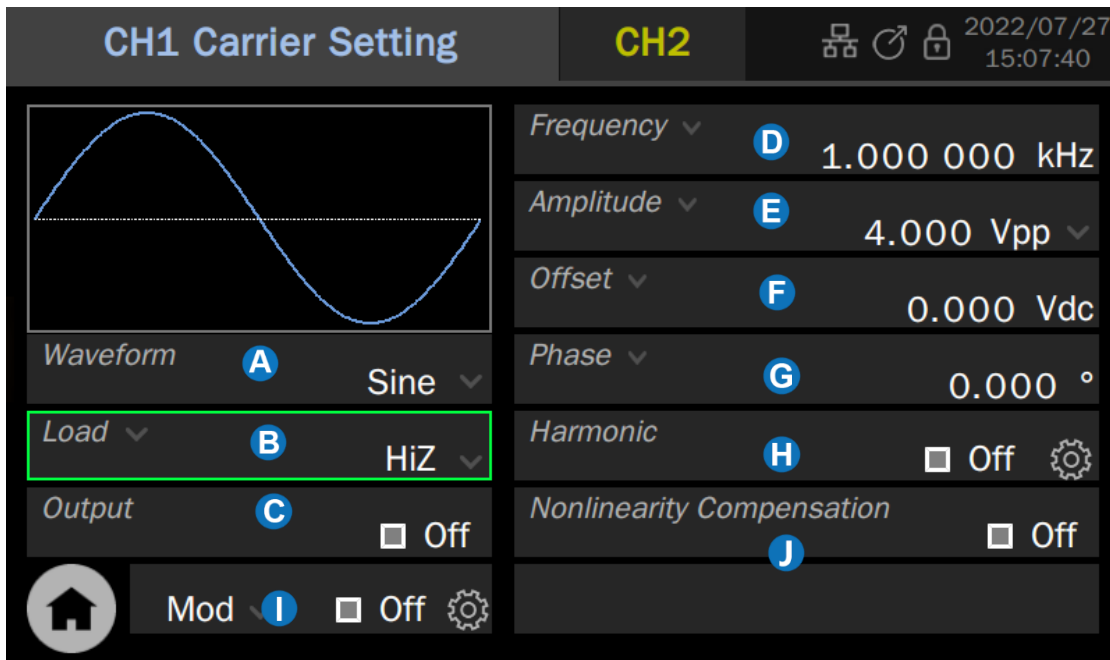

- A** Waveform setting box, where the waveform is selected
- B** Load parameter setting box, which is used to inform the device of the correct external load value.
- C** Output switch setting
- D** Frequency/Period parameter setting box
- E** Amplitude/High level parameter setting box
- F** Offset/Low level parameter setting box
- G** Phase/Delay parameter setting box
- H** Harmonic parameter setting box (for sine wave only)
- I** Modulation/Sweep/Burst setting
- J** Nonlinearity Compensation

Load

To understand how to set the load, we first need to understand how the voltage of the output port is obtained. The voltage V_o seen by the user is a variable related to the load R_L :

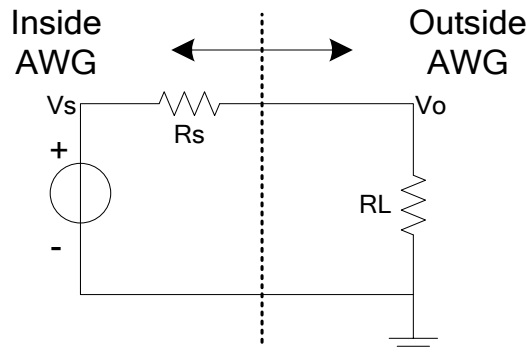

Figure 9-1

$$V_o = V_s \cdot \frac{R_L}{R_L + R_s}$$

Where V_s is the output voltage of the signal source before the output impedance R_s . Since the signal source cannot automatically identify the value of R_L , the user needs to inform the signal source of the value by inputting the "load" value, and then the signal source calculates the V_s according to the R_L and V_o set by the user so that the V_o obtained by the user is consistent with the expected value under any load.

Waveform Parameters

The parameters that can be set for each standard wave are different, as shown in the table below:

Table 9-1 Description of standard waveform parameters

Sine	
Frequency/ Period	Frequency/period of the signal. The unit of frequency is Hz and the unit of period is second. The relationship between the two is: Frequency = 1/period
Amplitude/ High level Offset/Low level	The amplitude/offset of the signal is linked with the High level/Low level. Amplitude value refers to the difference between the highest point (High level, unit V) and the lowest point (Low level, unit V) of the signal. The supported units include Vpp, Vrms, and dBm (available when the load \neq HiZ). Offset refers to the DC component superimposed on the signal waveform, in V. The relationship of the parameters is: Amplitude value (Vpp) = High level - Low level Offset = (High level + Low level) / 2

Phase / Delay	The Phase/Delay of the signal is meaningful only when the dual-channel phase mode = Locked, which is used to set the phase relationship between the two channels. The unit of Phase is °, the unit of Delay is second, and the relationship between them is: Delay = - (period x Phase / 360 °)
Square	
Frequency/ Period	Same as sine wave
Amplitude/ High level Offset/Low level	Same as sine wave
Phase / Delay	Same as sine wave
Duty Cycle	Ratio of positive pulse width to the period of the square wave, unit: %
Pulse	
Frequency/ Period	Same as the sine wave
Amplitude/ High level Offset/Low level	Same as the sine wave
Pulse width / Duty cycle	Pulse width refers to the positive pulse width of the pulse, unit second; Duty cycle refers to the ratio of positive pulse width to period, unit %. The relationship between the two is: Pulse width = Period x Duty cycle
Rising / Falling edge	The Rising edge refers to the rising time of 10% ~ 90%, and the Falling edge refers to the falling time of 90% ~ 10%, both in second. The Rising edge and Falling edge are independent of each other and can be set separately
Delay	Same as the "Delay" parameter of sine wave
Ramp	
Frequency/ Period	Same as the sine wave
Amplitude/ High level Offset/Low level	Same as the sine wave
Phase / Delay	Same as the sine wave
Symmetry	The ratio of the time during which the triangular wave is rising to the period, unit %
DC	
DC Offset	The same as the "DC Offset" parameter of sine wave



Application example: Set CH1 output sine wave with the following parameters

- Load = 50 Ω
- Frequency = 1 GHz
- Amplitude = 0 dBm
- Offset = 0 V
- Phase = 180°

1. Select the waveform

On the carrier setting page, click the waveform preview region or "Waveform" parameter setting box, and select "sine" in the pop-up waveform selection dialog box.

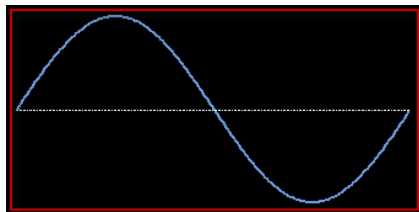

OR

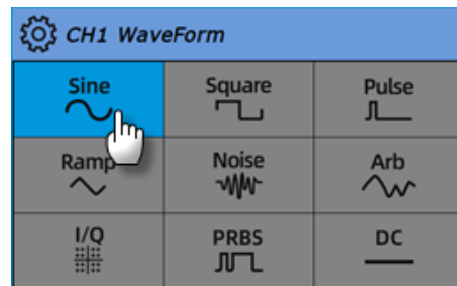

2. Set the load

Click the parameter value area of load in the "Load" parameter setting box, and select "50 Ω " in the parameter selection dialog box that pops up later:

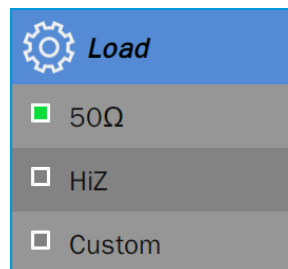

3. Set the waveform parameters

Set frequency: click the parameter value area of frequency in the "Frequency" parameter setting box, and then type and in sequence in the pop-up virtual keyboard. The input of values and units can also be realized using the numeric keyboard and knob on the front panel.

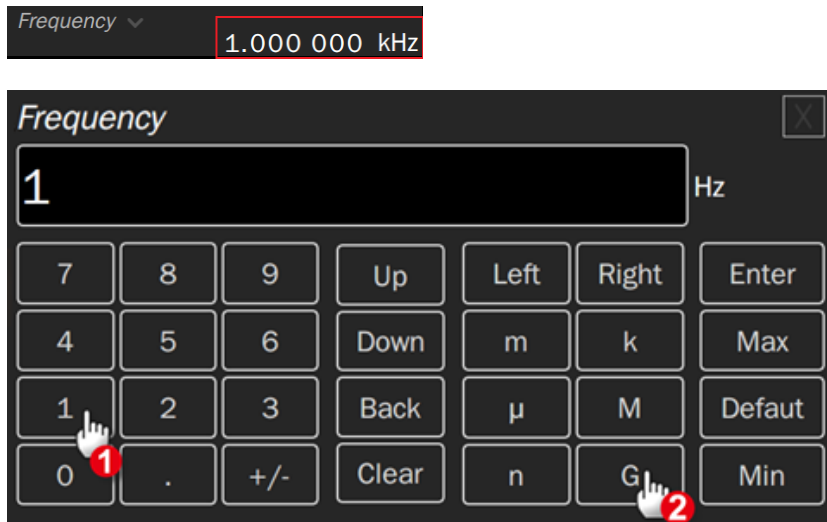

Set amplitude: Click the unit area in the "Amplitude" parameter setting box, and select "dBm" in the pop-up selection dialog box:



Click the parameter value area of amplitude and type and in sequence in the virtual keyboard:

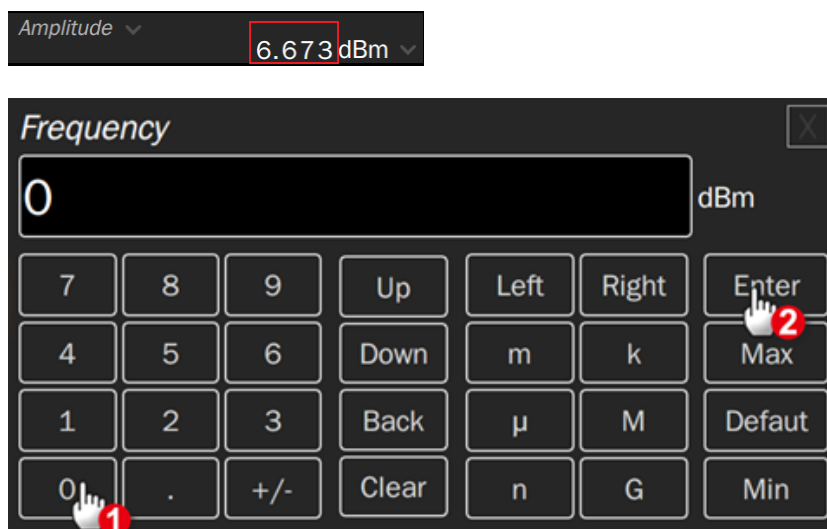

Set offset: Click the parameter value area of offset in the "Offset" parameter setting box, and then type and in sequence in the pop-up virtual keyboard.

Set phase: Click the parameter value area of phase in the "Phase" parameter setting box, and then type and in sequence in the pop-up virtual keyboard.

4. Enable the output

Switch the area in the "Output" parameter setting box, or directly press the output button corresponding to CH1 on the front panel.



Follow the above steps to output the expected sine wave. The carrier page after setting is as below:

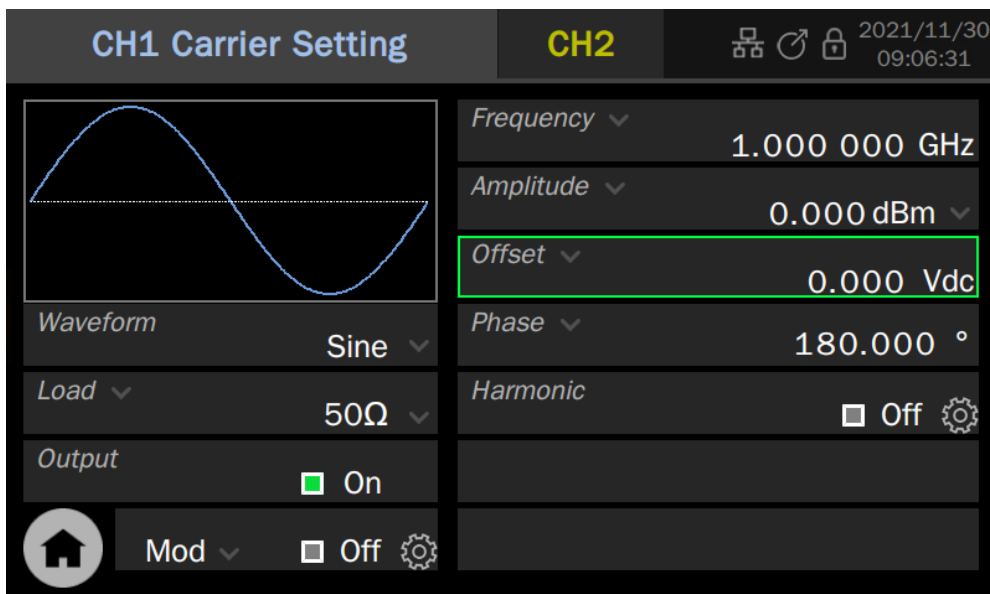

9.2 Harmonic Setting

Harmonic is a sub-function of sine wave generation function. It can output harmonics with specified order, amplitude, and phase settings, which is used to simulate sine waves with non-linearity.

On the parameter setting page where the carrier is a sine wave, click the setting icon in the "Harmonic" parameter setting box to enter the harmonic setting page.

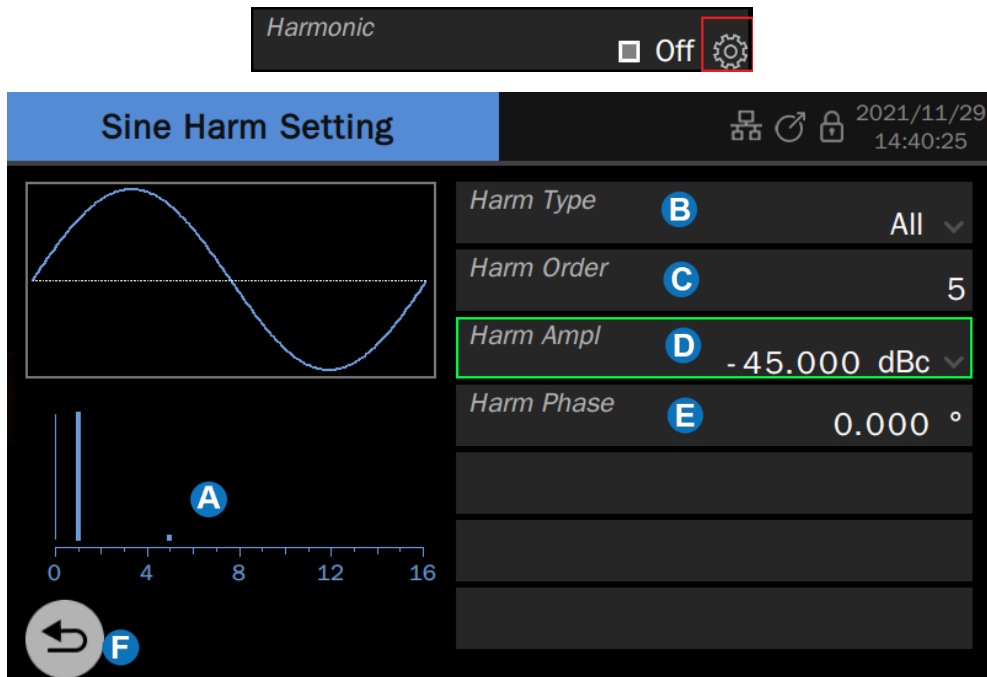

- A** Harmonic spectrum
- B** Harmonic type parameter setting box
- C** Harmonic order parameter setting box
- D** Harmonic amplitude parameter setting box
- E** Harmonic phase parameter setting box
- F** Return to previous menu

Set harmonic type

Click the parameter value area in the "Harm Type" parameter setting box, and select the harmonic type in the parameter selection dialog box that pops up later. If only odd harmonics are set, select "Odd"; if only even harmonics are set, select "Even"; if both odd and even harmonics need to be set, select "All"

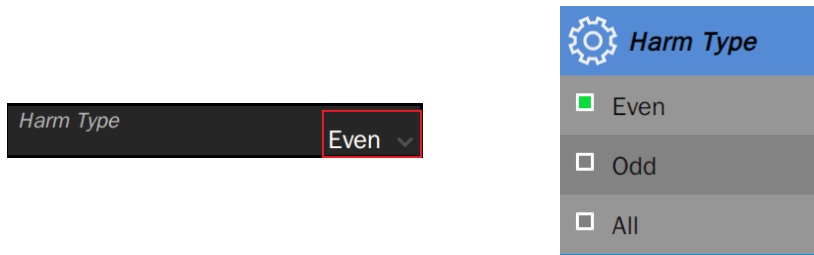

Set harmonic number

Click the parameter value area in the "Order" parameter setting box, and type the harmonic number to be set in the virtual keyboard that pops up later. If type = Odd, only odd value can be entered; If type = Even, you can only enter even values; If type = All, you can type any integer in the range of 2 ~ maximum harmonics.

Set harmonic amplitude

Step 1, click the harmonic amplitude unit area in the "amplitude" parameter setting box and select the unit as "Vpp" or "dBc". The unit "Vpp" is applicable to set the absolute amplitude of harmonic, and the unit "dBc" is applicable to set the relative amplitude of harmonics relative to the fundamental frequency signal. Step 2, click the harmonic amplitude parameter value area and then type the value to be set in the virtual keyboard that pops up.

Set harmonic phase

Click the value area in the "Harm Phase" parameter setting box, and type the value to be set in the virtual keyboard that pops up later. The unit of phase is $^{\circ}$

Turn on harmonic function

After all the harmonic parameters are set, the time domain waveform can be previewed in the waveform preview region, and the harmonics and their approximate amplitude can be browsed through the harmonic spectrum. After confirmation, return to the carrier parameter setting page and click the switch area in the "Harmonic" parameter setting box to turn on the harmonic function.



Application example: set CH1 output sine wave and its harmonics, and the parameters are as follows:

- Fundamental frequency = 1 kHz, Fundamental amplitude = 0 dBm
 - Second harmonic amplitude = -30dBc, phase = 0°
 - Third harmonic amplitude = -40dBc, phase = 0°
1. Refer to the application example in the previous section to set the waveform, frequency, and amplitude of the fundamental wave.
 2. Set harmonics

Because harmonics contain both 2nd and 3rd, you need to set the type to "All".

First set the amplitude and phase of the second harmonic: select "Order" as "2". Select the unit of "Harm Ampl" as "dBc", and then set the value to "-30". Set "Harm Phase" to "0", and the default unit is "°".

Then set the amplitude and phase of the third harmonic in the same way.

- Return to the carrier parameter setting page of the sine wave and set the switch of "Harmonic" to "On".

Following the above steps, the expected sine wave and harmonic can be sourced. The harmonic page after setting is as below:



The actual output spectrum is as follows:

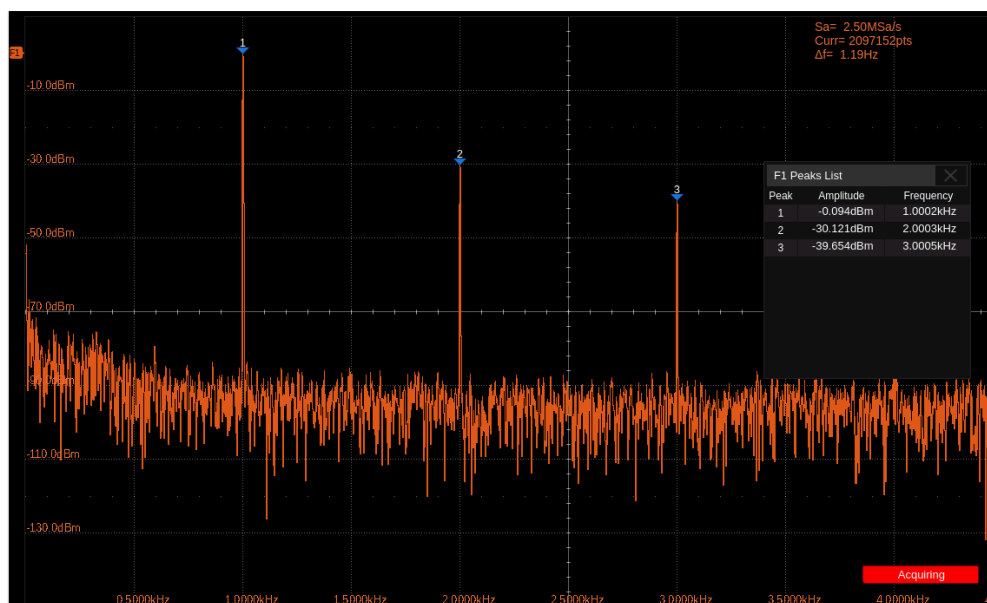

9.3 Noise Setting

The noise generation function can provide Gaussian noise with a settable bandwidth.

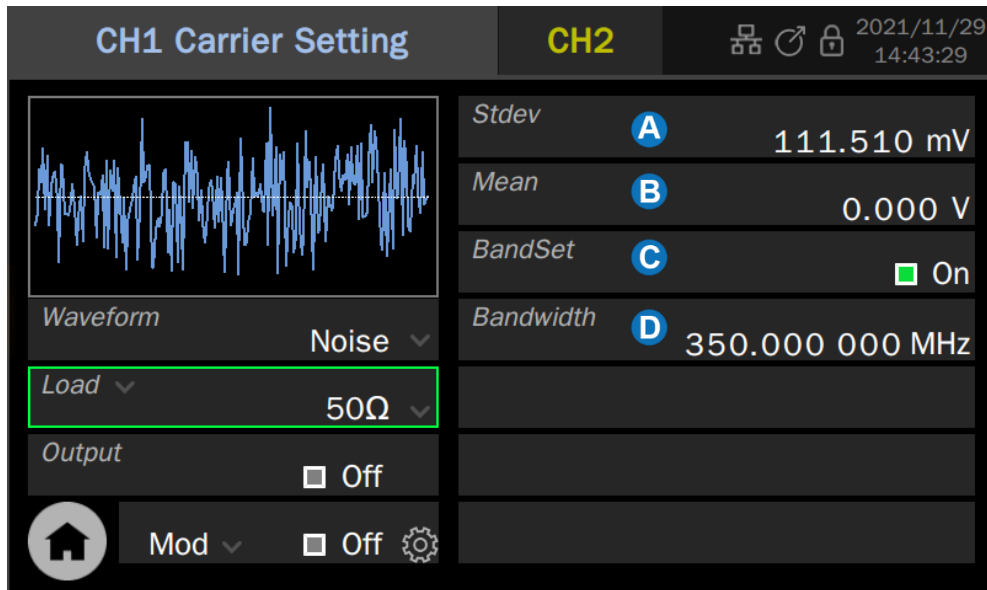

- A** Standard deviation parameter setting box
- B** Mean parameter setting box
- C** Bandwidth switch setting box
- D** Bandwidth setting box

Set the waveform parameters

The waveform parameters of noise include "Stdev" and "Mean". Since the noise obeys a Gaussian distribution (normal distribution), mean (μ) and standard deviation (σ) can characterize its distribution characteristics. The setting method refers to a sine wave.

Table 9-2 Description of Noise waveform parameters

Noise	
Stdev	Standard deviation
Mean	Average value (mathematical expectation)

Set the bandwidth

To set the bandwidth of noise, first click the switch area in the bandwidth switch setting box to open the bandwidth setting, then click the value area in the bandwidth setting box, at last type the value and unit in the pop-up virtual keyboard.



Application example: set CH2 to output noise of the following parameters

- Stdev= 100 mVrms
 - Mean = 0 V
 - Bandwidth = 1 MHz
 - The external load is high impedance
1. If the current parameter setting page is CH1, switch to CH2
 2. Set the waveform to "Noise"
 3. Set "Load" to "HiZ"
 4. Set "Stdev" to 100 mV
 5. Set "Mean" to 0 V
 6. Open "BandSet" and set the bandwidth to 1 MHz in the "Bandwidth" setting box
 7. Open output

Following the above steps, the expected noise can be output. The parameter page after setting is as below:

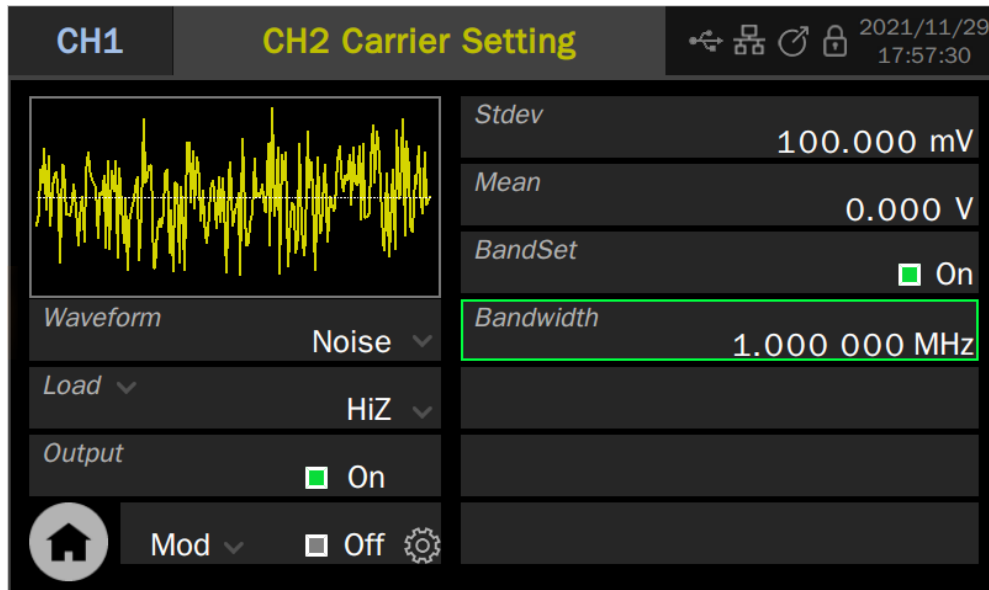

The time-domain waveform and spectrum of the actual output noise are as follows:

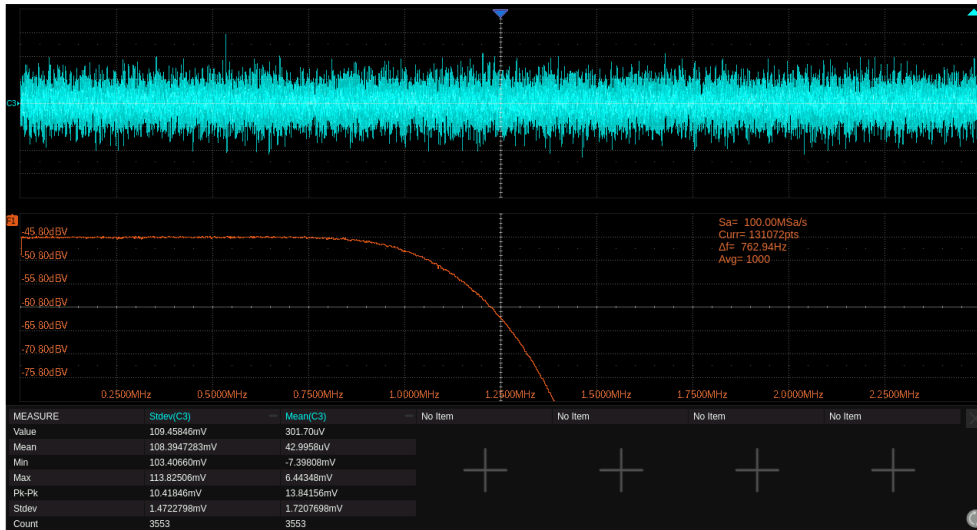

9.4 PRBS Setting

The PRBS generation function can generate PRBS sequences with a maximum bit rate of 625 Mbps.

CH1 Carrier Setting | **CH2** | 2021/12/01 11:05:21

Waveform: PRBS

Load: 50Ω

Output: Off

Bit Rate: **A** 200.000 000 Mbps

Amplitude: **B** 632.4 mVpp

Offset: **C** 0.000 Vdc

Logic Level: **D** Custom

E Length: PRBS - 10

Rise/Fall: **F** 1.000 ns

- A** Bit rate / Period parameter setting box
- B** Amplitude / High level parameter setting box
- C** Offset / Low level parameter setting box
- D** Logic level parameter setting box
- E** Length parameter setting box
- F** Rise/Fall edge parameter setting box

Set the waveform parameters

The waveform parameters of PRBS are shown in the table below. The setting method refers to the sine wave.

Table 9-3 PRBS waveform parameter description

PRBS	
Bit rate/ Period	Bit rate/symbol period of the PRBS sequence. The unit of bit rate is bps and the unit of symbol period (UI) is second. The relationship between the two is: Bit rate = 1 / Period
Amplitude / High level Offset /Low level	Same as the sine wave
Logic Level	Used to quickly set the amplitude to some standard levels. See “Table 9-4” for details
Length	PRBS-3 ~ 32 can be set, corresponding length $(2^3-1) \sim (2^{32}-1)$
Edge	Refers to the rise time of 10% ~ 90% and the fall time of 90% ~ 10%, with the unit of second. Both rising and falling edges are set at the same time

Table 9-4 Logic levels supported by PRBS

Logic level	Amplitude (Vpp)	Offset (V)
TTL/CMOS	5.00	2.50
LVTTL/LVCMOS	3.30	1.65
ECL	0.80	-1.30
LVPECL	0.80	2.00
LVDS	0.35	1.25



The preset logic levels in the table are valid only when output mode = single ended.



Application example: set CH1 to output PRBS with the following parameters

- Differential output, external differential load 100 Ω
- Bit rate = 122.88 Mbps

- Amplitude = 300 mVpp
 - Common Mode= 600 mV
 - Length is PRBS-7
 - Rise/Fall edge = 1 ns
1. In "Output Setting", set the output mode of CH1 to "Differential" (see "Single-ended/Differential Settings" for details), connect the "+" terminal of CH1 to the "+" end of the 100 Ω differential load, and the "-" terminal of CH1 to the "-" end of the 100 Ω differential load
 2. On the carrier parameter setting page of CH1, set the "load" to 100 Ω .
 3. Set the bit rate to 122.88 Mbps;
 4. Set the amplitude to 300 mVpp and the offset to 0
 5. Set "Common Mode" to 600 mV
 6. Set "Length" to PRBS-7
 7. Set "Rise/Fall" to 1ns
 8. Open the output

Following the above steps, the expected PRBS waveform can be output. The parameter page after setting is as below:

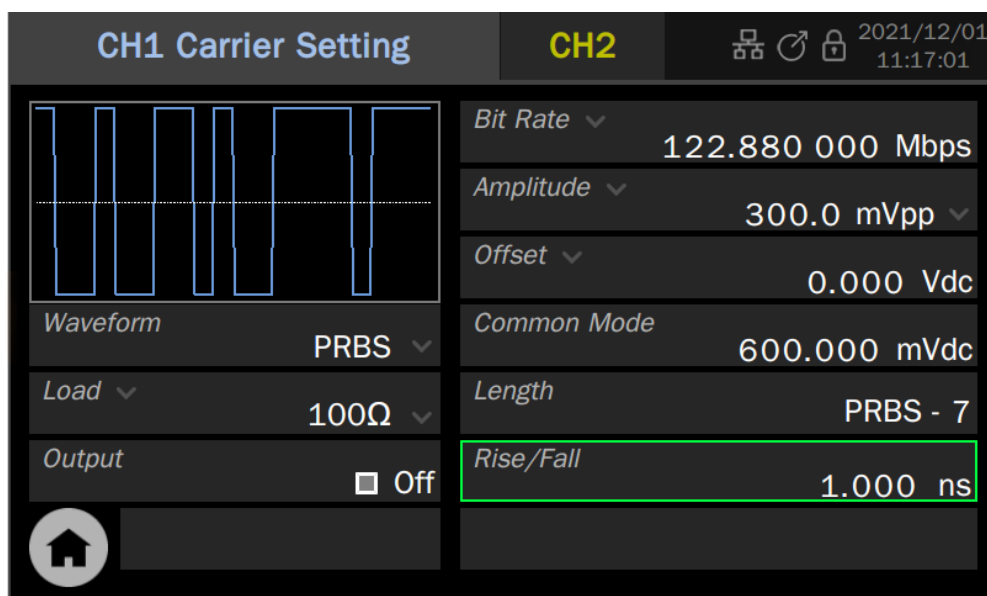

The actual output PRBS waveform is as follows. C1 of the oscilloscope captures the "+" end of the differential signal, and C2 captures the "-" end of the differential signal, $F1 = C1 - C2$, that is, the equivalent differential signal.

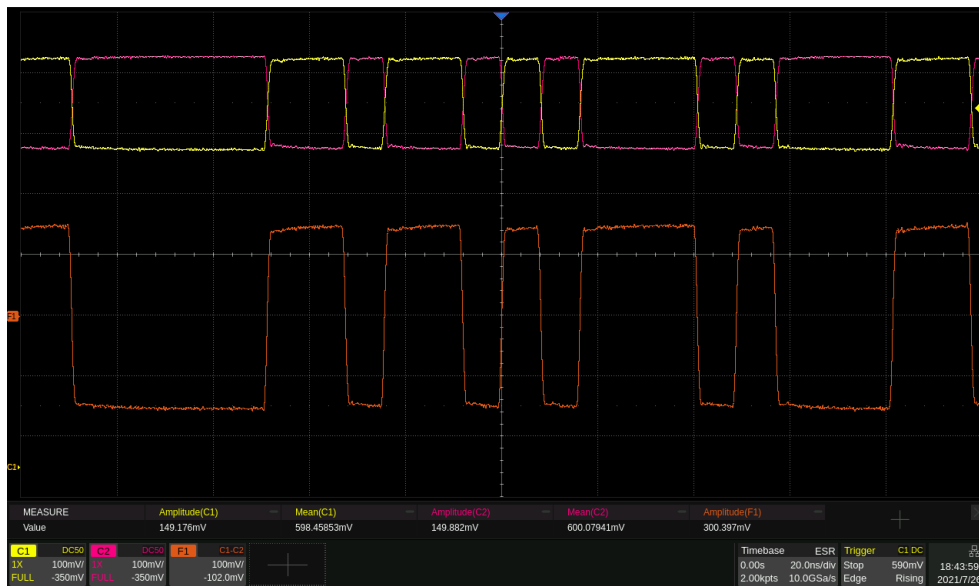

In this application example, because the common mode is limited in (-1 V ~ +1 V), some levels with large common-mode voltages, such as LVDS (1.25 V) and LVPECL (2.0 V), cannot be simulated. An alternative is to simulate the differential output by two complementary single-ended outputs.

The following is an example of simulating a pair of differential outputs through two single-ended outputs.



Application example: Set a PRBS with the following parameters using CH1 as differential "+" and CH2 as differential "-"

- External differential load 100Ω
 - Bit rate = 300 Mbps
 - LVPECL level
 - Length is PRBS-32
 - Rise/Fall edge = 1 ns
1. In "Output Setting", set the output mode of CH1 to "Single-ended" (see "Single-ended/Differential Settings" for details), connect the "+" terminal of CH1 to the "+" end of the 100 Ω differential load, and the "+" terminal of CH2 to the "-" end of the 100 Ω differential load
 2. On the carrier parameter setting page of CH1, set the load to 50 Ω
 3. Set the "Bit rate" to 300 Mbps;
 4. Set "Logic Level" to "LVPECL", and the device will automatically set "Amplitude" to 800 mVpp and "Offset" to 2 V;
 5. Set length to PRBS-32;
 6. Set "Rise/Fall" to 1 ns;

7. In the "Dual Channel" page, execute the "CH1-> CH2" operation of "Channel Copy" to copy the parameters of CH1 to CH2. If you want CH2 links changes on CH1, turn on "Freq Coupling", "Amplitude Coupling" and "Phase Coupling" in "Channel Coupling" and set "Freq Ratio" = 1, "Ampl Ratio" = 1 "and" Phase Ratio"= 1 (see the section "Channel Tracking/Coupling/Copy" for details);
8. In output settings, set the polarity of CH2 to "Invert";
9. Turn on the output of both channels.

Following the above steps, the expected PRBS waveform can be output. The parameter page after setting is as below:

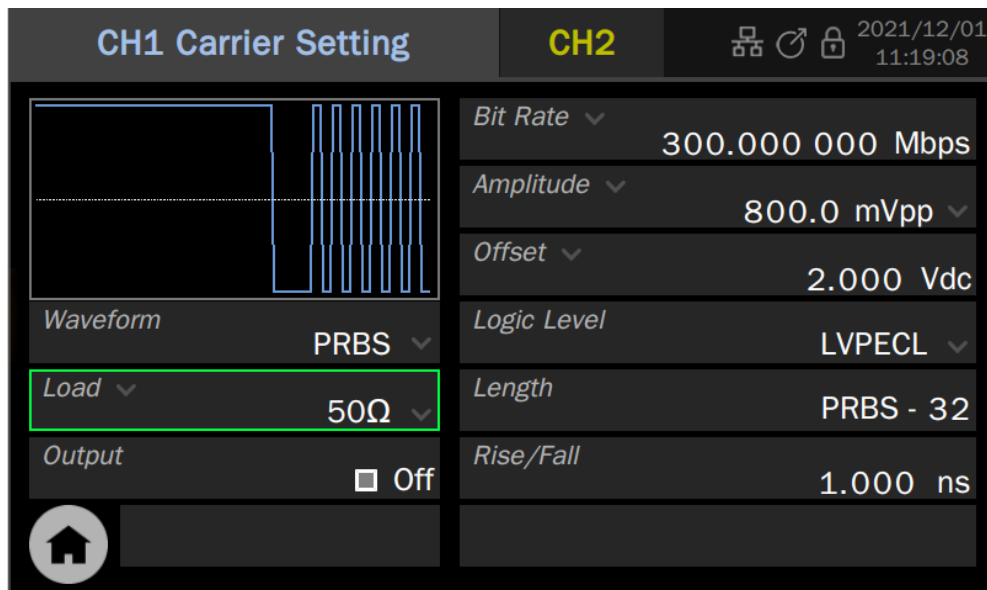

The actual output PRBS waveform is as follows. C1 of the oscilloscope captures the "+" end of the differential signal, C3 captures the "-" end, F1 = C1-C3, that is, the equivalent differential signal.

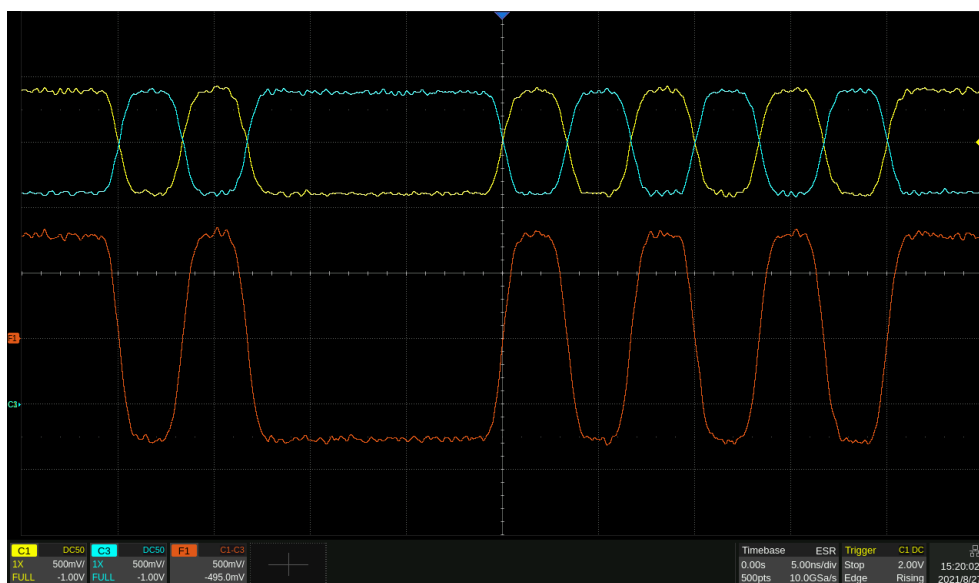

9.5 Arbitrary Waveform Setting

Arbitrary waveform provides two modes: AFG and AWG. On the parameter setting page where the carrier is an arbitrary waveform, click the value area of the "Mode" parameter setting box to select the required mode:

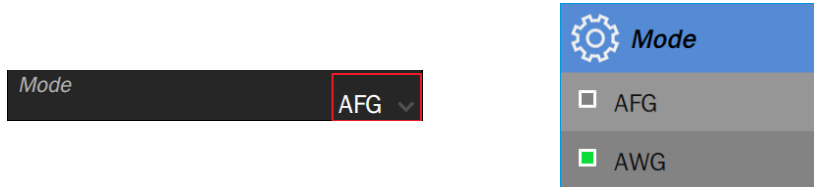

9.5.1 AFG Mode

In AFG mode, the signal generator outputs the specified arbitrary waveform in the way of traditional Direct Digital Synthesis (DDS) generators. At this time, the basic waveform parameter setting is the same as that of the sine wave. Refer to the section "Standard Waveform Setting".

For data source selection and editing of an arbitrary wave, refer to the section "Data Source".

9.5.2 AWG Mode

In AWG mode, the signal generator employs SIGLENT's TrueArb Technology (Figure 9-2) and outputs the specified waveform sequence point-by-point with a user-specified sample rate. TrueArb overcomes the intrinsic defects of traditional DDS technology that may increase jitter and distortion when generating arbitrary waves, while retaining its advantages of low cost, simplicity and flexibility.

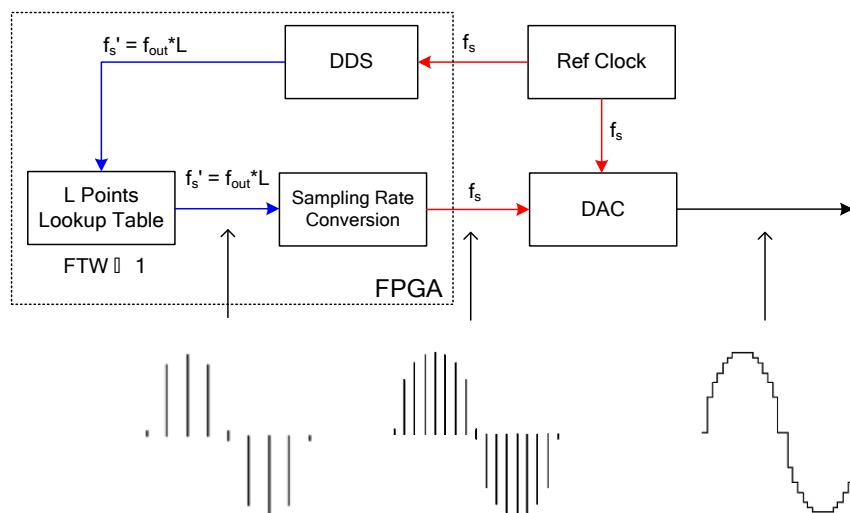
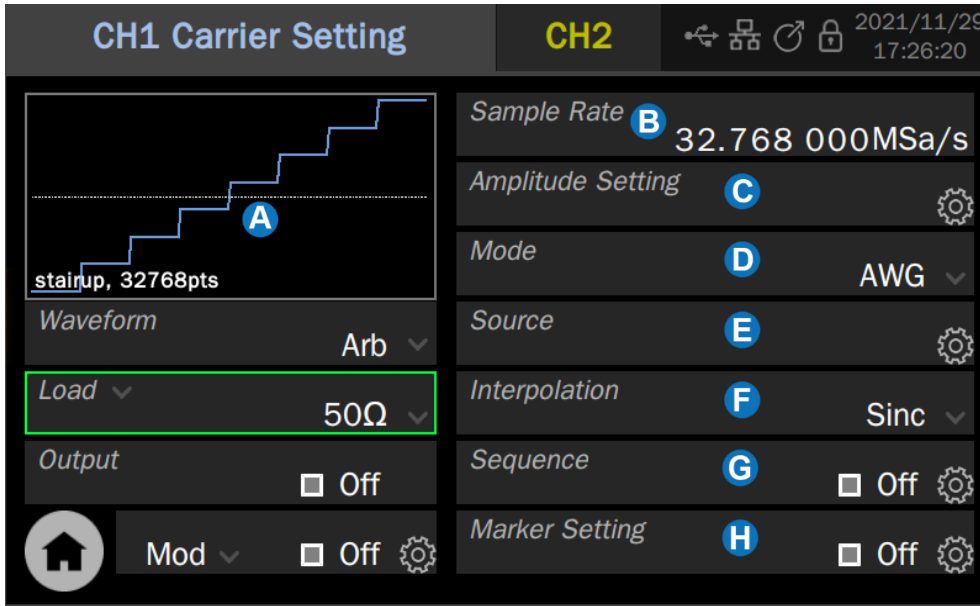

Figure 9-2 Principle block diagram of TrueArb Technology



- A** Waveform Preview
- B** Sample rate / Frequency parameter setting box
- C** Amplitude parameter setting box
- D** Mode parameter setting box
- E** Data source selection
- F** Interpolation mode parameter setting box
- G** Sequence setting
- H** Marker setting

Set the waveform parameters

The waveform parameters of AWG are shown in the table below. The setting method refers to that of a sine wave.

Table 9-5 Description of AWG waveform parameters

AWG	
Sample rate / Frequency	Sample rate / Frequency of the signal. The unit of sample rate is Sa/s, which refers to the clock rate of the waveform. The unit of frequency is Hz. The relationship between the two is: Sample rate = Frequency x number of waveform points
Amplitude/High level Offset/Low level	Same as the sine wave
Interpolation	Interpolation mode. Refer to “Table 9-6” for the details

Table 9-6 Interpolation modes supported by AWG

Interpolation	Explanation
0-order hold	Zero-order hold
Linear	Linear interpolation
Sinc	Sinx/x interpolation
Sinc27	Sinx/x interpolation combined with low-pass filter, bandwidth = 0.27 x sample rate
Sinc13	Interpolation combined with low-pass filter, bandwidth = 0.13 x sample rate

9.5.3 Data Source

Click the setting icon  in the "Source" parameter setting box to enter the data source selection page. Data sources include Built-In, From File, and EasyWaveX. Click the data source type area in the "Source" parameter setting box, and then select the data source in the pop-up list.

Built-In Waveform

The built-in waveforms are a series preset waveforms in the signal generator. There are a few types: Common, Math, Engineering, Window, Trigo, Square, Medical electronics, Modulation, Filter and Demo. Under each type, there are a variety of waveforms to choose.

Click the value area of the "Wave Type" parameter setting box, and then select the waveform from the waveform list on the right. When a page cannot be displayed all the waveforms, a scroll bar will appear on the right side of the list. Scroll the bar up and down to view the entire list.

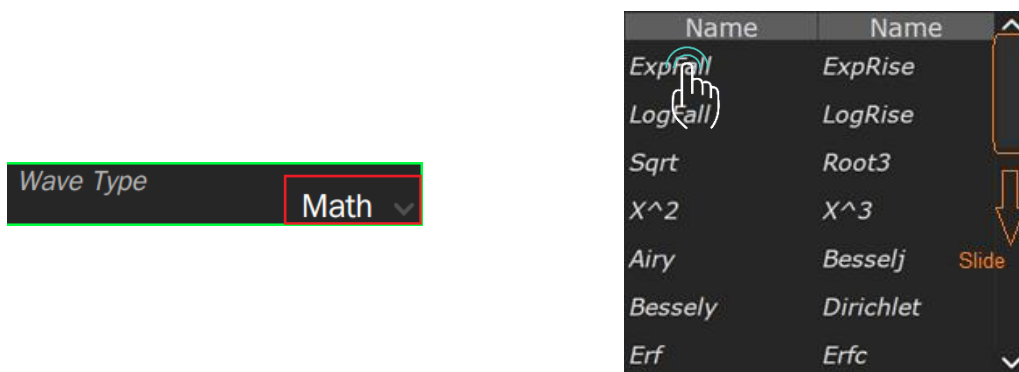

From File

"From File" is to recall a waveform file saved in the local directory or external USB flash disk. When the data source is "From File", the File Manager will be called automatically. Select the waveform, and then click "Load".

For operations of the File Management, please refer to the chapter "Save/Recall".

EasyWaveX

The arbitrary waveform editing software EasyWaveX provides 11 standard waveforms such as sine, square, ramp, pulse, noise, and DC, which can meet the most basic needs. It also provides users with manual drawing, line drawing (including horizontal line, vertical line, and two-point line), coordinate drawing (coordinates can be input through mouse or table, and there are two ways of connecting line and smoothing) and equation drawing, which makes it easy to create complex waveforms.

SDG7000A not only supports the waveforms issued by EasyWaveX software running on the PC but also integrates EasyWaveX into the device as a built-in application so that it supports editing and saving waveforms directly on the device. When "EasyWaveX" is selected as the data source, the EasyWaveX software will be automatically run on the device:

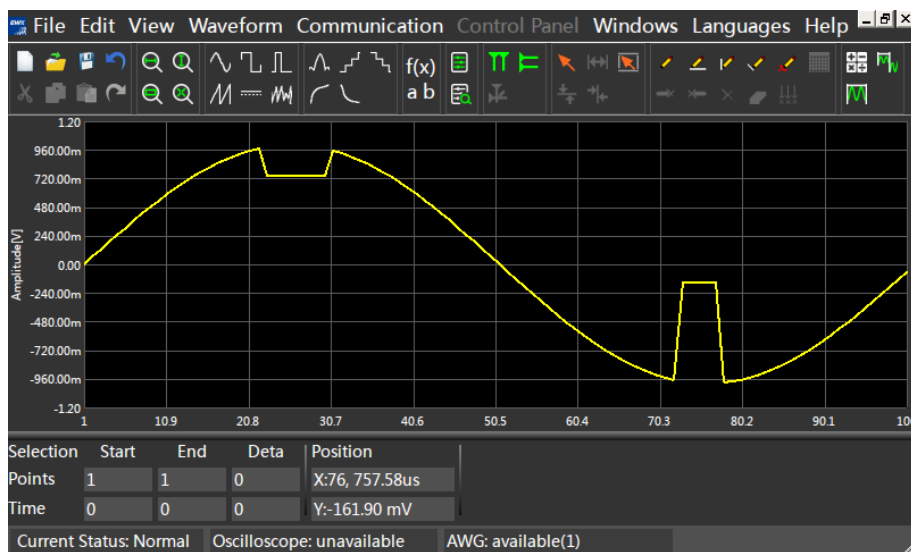

Figure 9-3 EasyWaveX operation interface

After the arbitrary waveform is edited in the EasyWaveX, the waveform update can be completed through the "Send Waveform to AWG" command under the "Communication" menu of the software. Click File -> exit in the software menu bar to exit. It is recommended to use a mouse to operate the software or operate it over WebServer.

For the use of EasyWaveX, please refer to the help of the software itself.



Application example: Set CH1 to output the AWG waveform of the following parameters, and the data source is from the file edited by EasyWaveX

- External load 50Ω
- Sample rate = 160 MSa/s
- Amplitude = 2.5V; Offset = 1.25V
- The file has 160 points, and the waveform is a sine wave
- Set the interpolation method respectively "Sinc" and "0-order hold", and compare the output waveforms.

1. On the carrier parameter setting page of CH1, set "Waveform" to "Arb" and "Mode" to "AWG"
2. Set "Load" to 50 Ω
3. On the "Source" setting page, select "Source" as "EasyWaveX", and the device will automatically call the built-in EasyWaveX application.

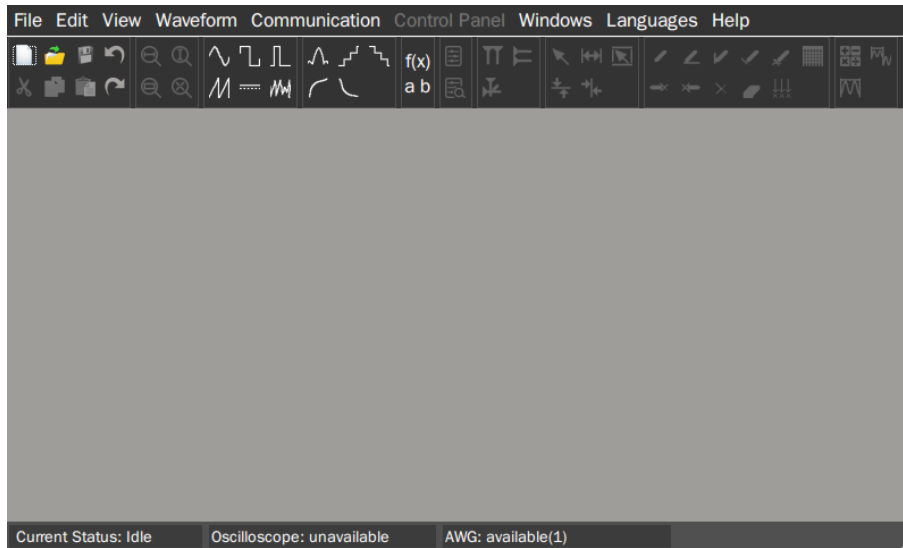

4. In the operation interface of the EasyWaveX, create a new blank waveform file through **File** > **Blank Waveform**.
5. In the pop-up dialog box, set the number of points to "Variable" and 160 points in the "Sample" column, and click OK.

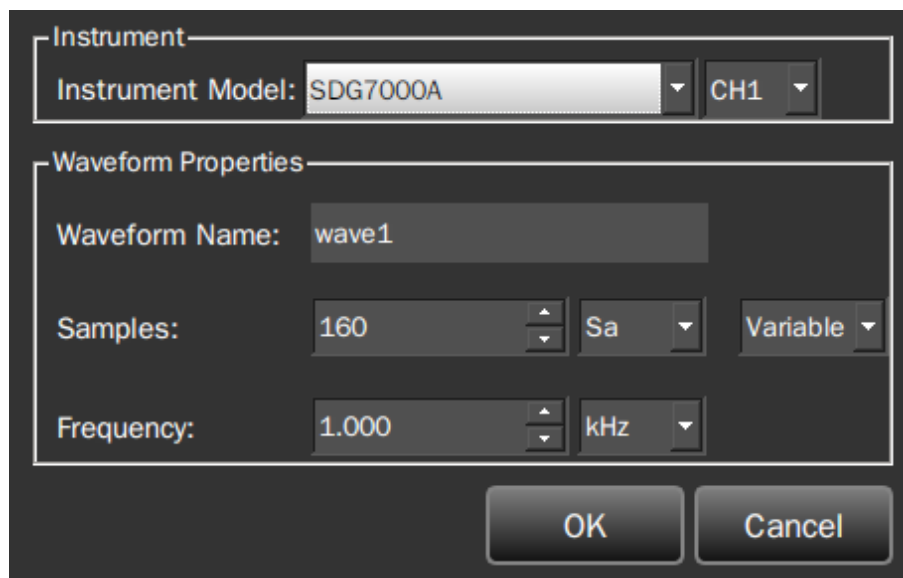

6. Create a sine wave through **Waveform** > **Sine**, and set the amplitude in the pop-up setting dialog box: select "Max/Min", and then set High Level = 2.5 V and Low Level = 0 V.

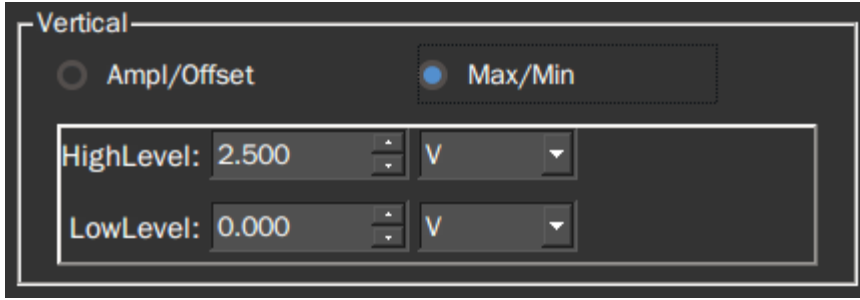

- At this time, the waveform has been generated. Execute **Communication** > **Send Waveform to AWG** to AWG to load the waveform to the waveform memory.

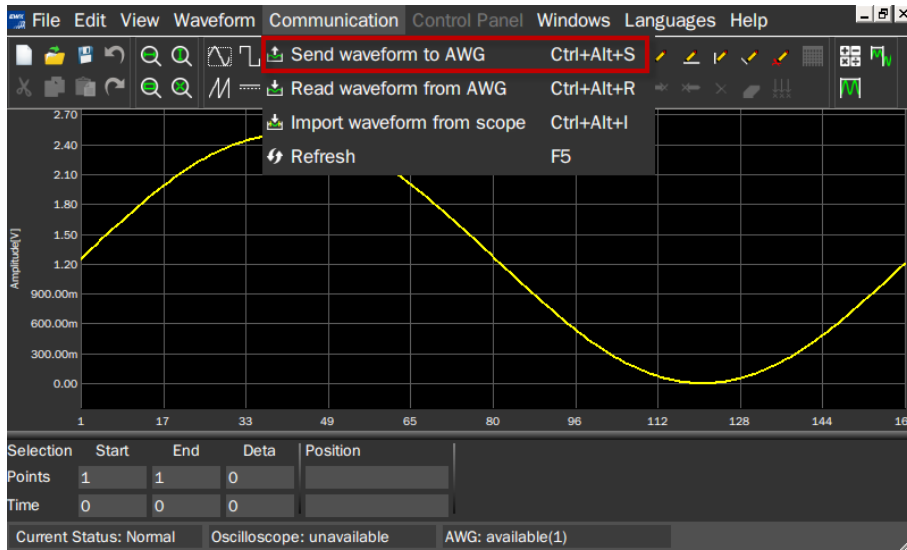

- Execute **File** > **Exit** to exit EasyWaveX, and then select "yes" or "no" according to your needs in the prompt box of whether to save the file.
- Return to the waveform parameter setting page, we will find that since the amplitude is preset in the EasyWaveX, the amplitude parameter has been automatically set as expected. However, since the frequency is not set (1 kHz by default), the sample rate (160 kSa/s) is incorrect at this time.

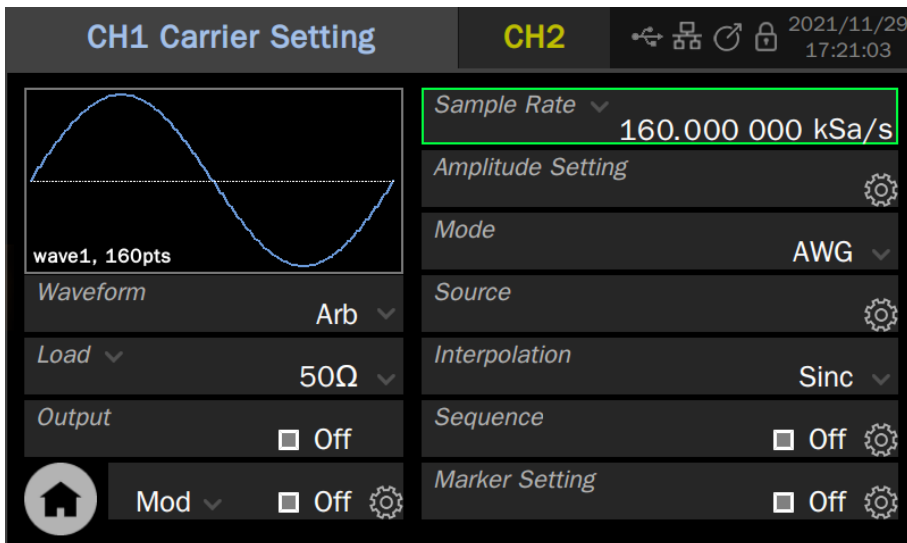

10. Set the sample rate to 160 MSa/s and the interpolation method to Sinc.
11. Enable the output and observe the waveform using a oscilloscope
12. Set the interpolation method to 0-order hold and observe the waveform.
13. Since the sample rate = 160 MSa/s and the number of waveform points = 160 pts, the observed waveform frequency (sample rate /number of points) is 1 MHz.

The following is a comparison of waveforms under two interpolation modes:

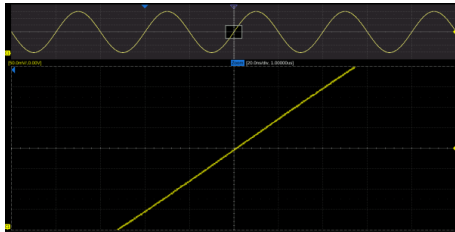

Sinc interpolation

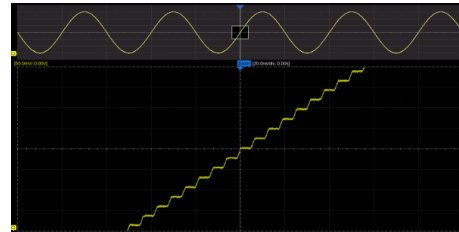

"0-order hold" interpolation



Application example: The PC software EasyWaveX is used to generate the waveforms of digital clock and data simulating the following timing relationship, download them to the signal generator, and output them from CH1 and CH2 with adjustable bit rate.

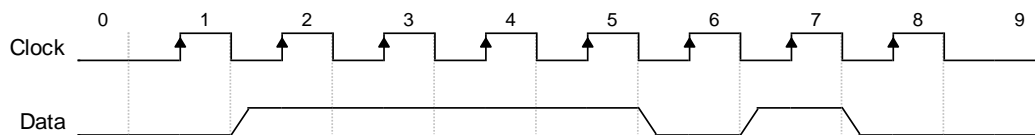

1. Connect the device and the computer installed with the EasyWaveX by USB or LAN.
2. Start EasyWaveX and create a 30-point arbitrary waveform. The operation instructions are the same as that of the built-in EasyWaveX device
3. In the "Property" area of the toolbar, select "Waveform Property" , and input the level of each point one by one in the "Point Table" according to the "0" and "1" pattern of the clock, as shown in the following figure:

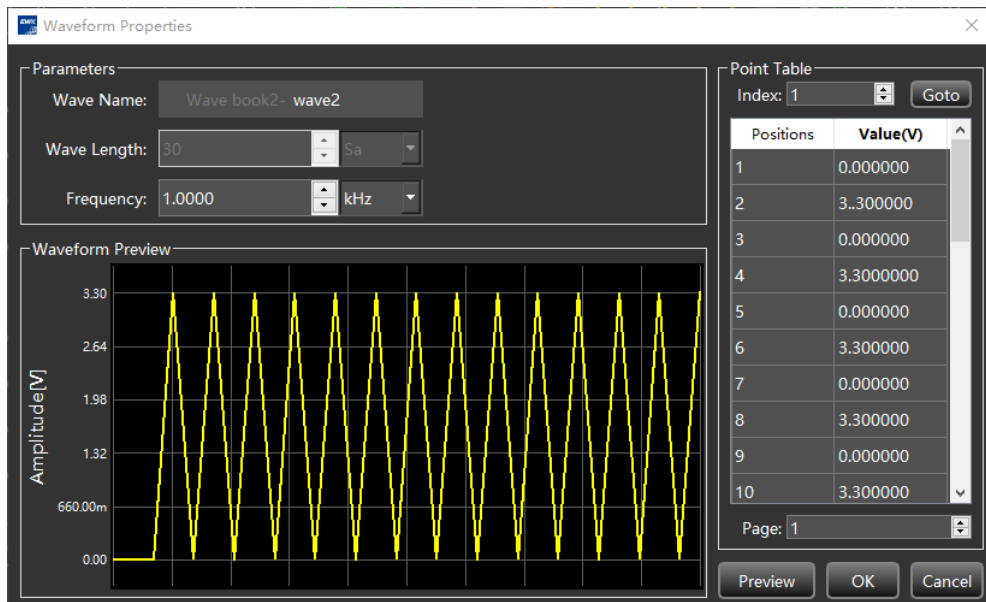

- The waveform generated can be previewed in the waveform preview window. Select "Display Properties"  in the "Property" area of the toolbar, and change the "Interpolation" to "0-order hold", to obtain the correct waveform preview of the digital clock:

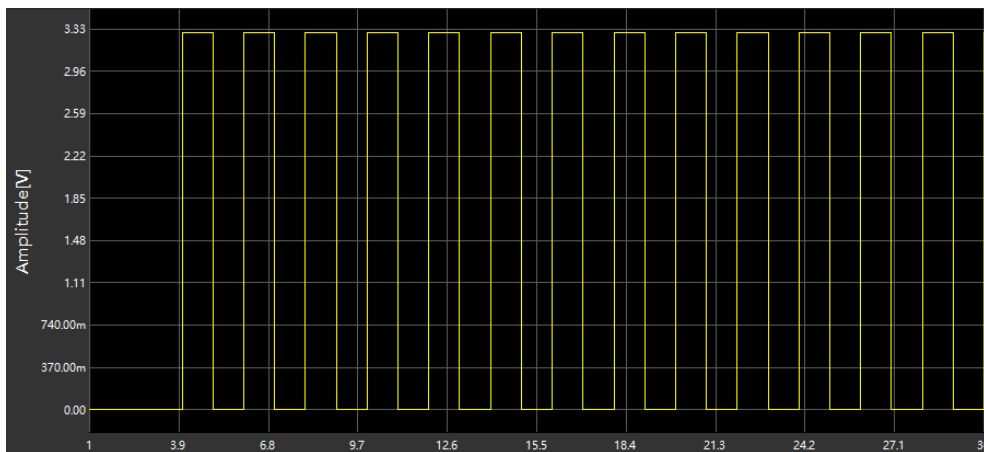

- Execute Communication > Send waveform to AWG, select the device in the pop-up dialog box, click Connect, and select the target channel as CH1 to download:

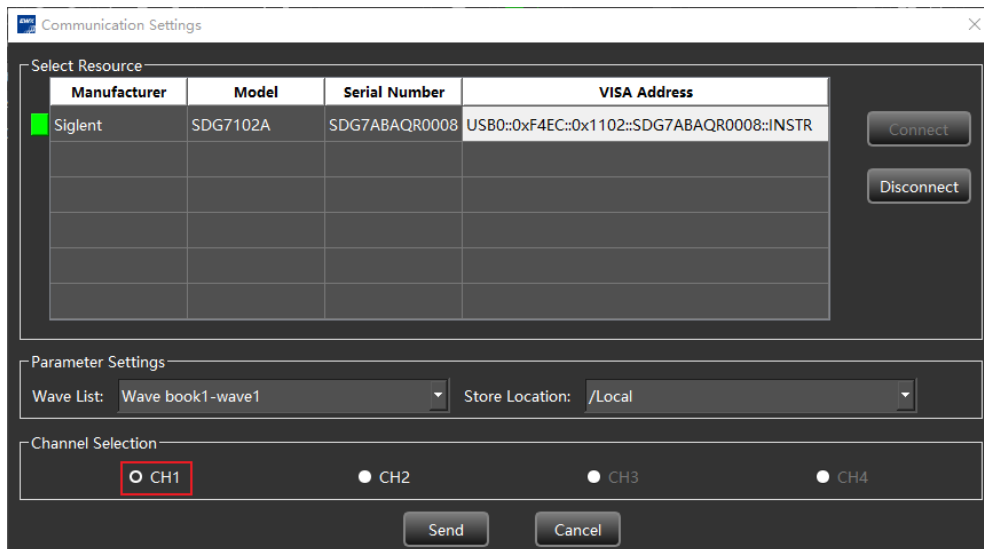

- Use the same method to generate the data file and download it to CH2 of the device.
- Set the "Interpolation" of the two channels to "0-order hold" on the device.
- Set the amplitude and rate of the clock and data output on the device as required. For example, to set the clock frequency to 1 MHz set the "Sample Rate" of the clock channel to 2 MSa/s. Since the clock and data are synchronized, CH1 and CH2 can be set as frequency coupling with a ratio of 1 (Read the section "Channel Tracking/Coupling/Copy" for the setting method). In this way, only the rate of one channel needs to be set, and the rate of the other channel can be updated synchronously. The clock and data signals finally output by the device are as follows:

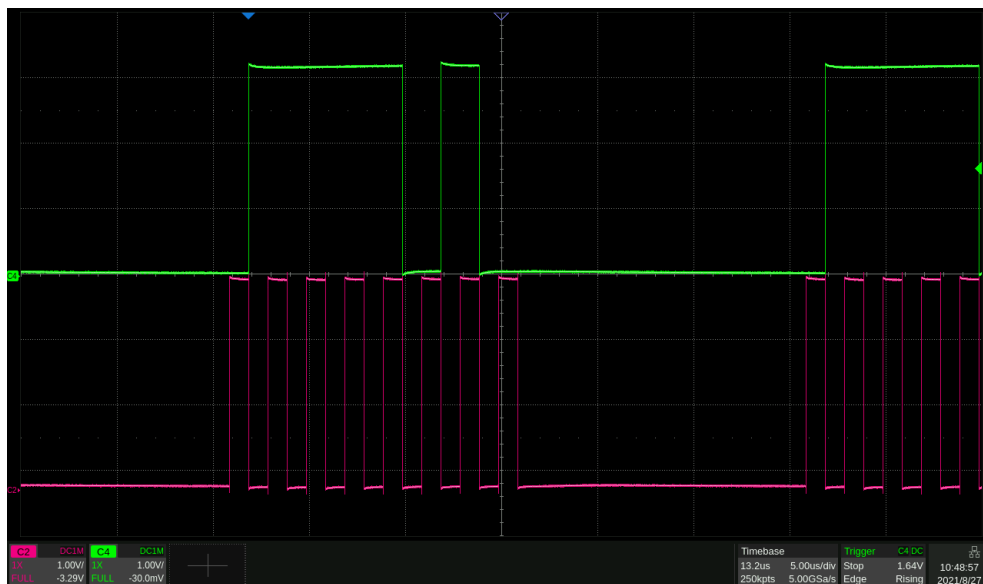

The waveform generated by EasyWaveX can be saved as a csv file for further editing. After editing, it can be imported into EasyWaveX and loaded to the device through EasyWaveX. You can also store the csv file to the USB flash disk, and the device can recall it directly from the USB flash disk.

9.5.4 Sequence Setting

Sequence refers to the combination of multiple arbitrary waveforms in the form of "Segments". The generation of sequences is realized through the embedded Sequence Editor. The Sequence Editor can combine up to 1024 segments into a sequence. The source of each segment can be individually specified as a Built-In waveform, saved waveform, or EasyWaveX waveform. The number of repetitions of each segment can be set. In addition, the Sequence Editor also provides some advanced functions of triggering and jumping between segments.

On the carrier parameter setting page of Arb, when the mode is "AWG", or on the parameter setting page of the digital channels, click the setting icon in the "Sequence" parameter setting box to enter the editing and playback control of Sequence.

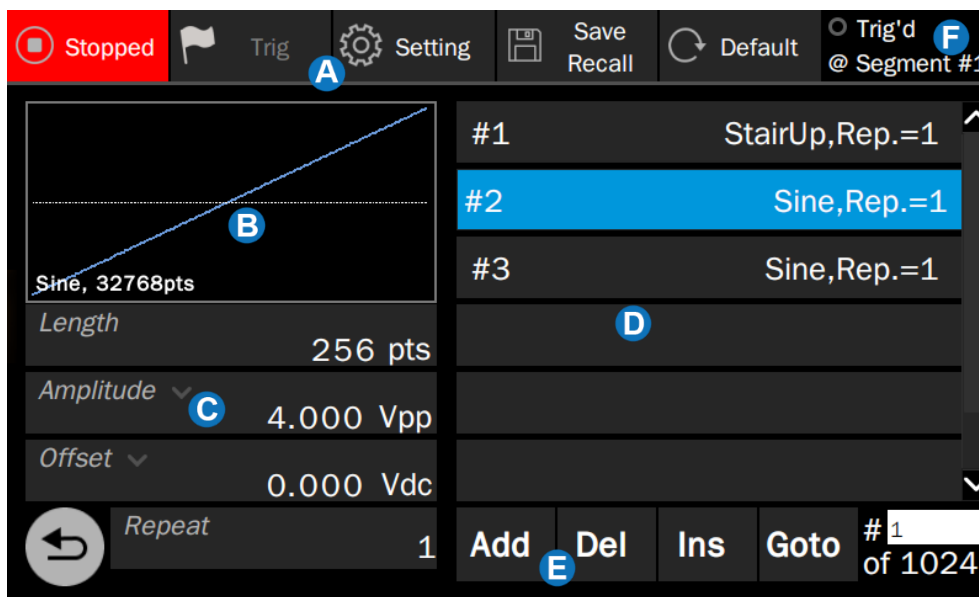

- A** Menu bar
- B** Waveform preview and waveform data source selection, the waveform preview of the currently active segment is displayed. Click this area to select the waveform.
- C** The waveform parameter setting area is used to set the basic parameters of the currently active segment.
- D** Segment list, in which the currently active segment is highlighted
- E** Segment setting area
- F** Trigger information display area



In the Sequence Editor, you can directly control the playback or stop of the sequence. Editing is not allowed during playback. To edit a sequence, you need to stop the playback first.

Set the Waveform Parameters

The waveform parameter area of the Sequence Editor displays the basic parameters of the currently active segment. The parameters are described in the table below. The setting method refers to the sine wave.

Table 9-7 Description of waveform parameters of segment

Sequence	
Length	The length of the segment can be different from the length of the specified waveform, and can be set to be less than or greater than the length of the waveform. When the length of the segment > the length of the waveform, the device generates the segment by upsampling. When the length of the segment < the length of the waveform, the device generates the segment by downsampling. There are several upsample and downsample methods (refer to Table 9-9 and Table 9-10), which can be specified by Setting > Increasing and Setting > Decreasing.
Amplitude/High Level Offset/Low Level	Same as the sine wave
Repeat	The number of times this segment is repeated in the sequence, ranging from 1 to 65535



The length of the segment should be ≥ 64 . If the length is less than 256, it must be an integer multiple of 16. If it is greater than or equal to 256, there is no limit.

Segment Operation

The main parameters information of each segment is displayed in the segment operation area, and several segment operations are provided at the bottom, as shown in the following table:

Table 9-8 Description of segment operation

Operation	Description
Add	Add a new segment at the end of the sequence
Del	Deletes the currently active segment
Ins	Inserts a new segment above the currently active segment
Goto	Jump the segment whose index is specified in the following text box

Setting

Click Setting in the menu bar to enter the parameter setting page of the sequence. This page provides the following parameter settings:

Table 9-9 Increasing method

Increasing method	Description
Interpolation	Linear interpolation between points
Zero	Fill zero after the waveform's end
Hold last	Repeat the last point after the waveform's end
Duplication	After the waveform's end, repeat the waveform points from the first point until the length of the segment is reached

Table 9-10 Decreasing method

Increasing method	Description
Decimation	The segment is obtained by proportional decimation of the waveform.
Cut Tail	Keep the head of the waveform according to the segment length and cut off the tail.
Cut head	Keep the tail of the waveform according to the segment length and cut off the head.



The effects of different upsample/downsample methods can be reflected in the waveform preview.

Table 9-11 Trigger mode

Trigger mode	Description
Button	Click the Trigger button on the menu bar to trigger, equivalent to manual trigger.
Timer	Triggered by the internal timer.
External	Triggered by the external trigger.

Table 9-12 Run mode

Run mode	Description
Continuous	The continuous cyclic output of the sequence.
Single/Burst	After the trigger conditions are met, the sequence is output for specified cycles.

Infinite	After the trigger conditions are met, the sequence is output continuously.
Step	One segment is output at each trigger, and each segment is output in sequence.
Advanced	Jump from one segment to any other, and the trigger conditions of a jump can be set (refer to Table 9-11 Trigger mode).

Table 9-13 Marker

	Description
Maker Setting	Marker output, synchronous output at the specified segment, and point

Save/Recall

Save the current sequence settings as a file (*.awg), or load a saved sequence file. For the operation instructions of save/recall see the chapter "Save/Recall".



Application example: Output a sequence with the following segments in turn.

- Waveform = Sine, 32768 points, 2 Vpp, repeat once
 - Waveform = Square_Duty50, 32768 points, 1 Vpp, repeat twice
 - Waveform = UpRamp, 32768 points, 2 Vpp, repeat 3 times
1. On the carrier parameter setting page, open the "Sequence" function.
 2. Enter the "Sequence" setting, and the device will automatically call the Sequence Editor.
 3. Click the waveform preview area to specify the data source of segment 1, select "Source" as "Built-In" in the subsequent data source selection interface, select "Sine" in the directory of "wave Type" = "Common", and return to the Sequence Editor.
 4. Set the number of repeat to 1.
 5. Set amplitude to 2 Vpp and offset to 0 V.
 6. Click **Add** to add segment 2.
 7. Set the waveform and parameters of segment 2 according to the similar operations in steps 3 ~ 5.
 8. Click **Add** to add segment 3.
 9. Set the waveform and parameters of segment 3 according to the similar operations in steps 3 ~ 5.
 10. Click the "Running/Stopped" button to start the sequence playback.

11. Open the output.

The following figure shows the actual output waveform:

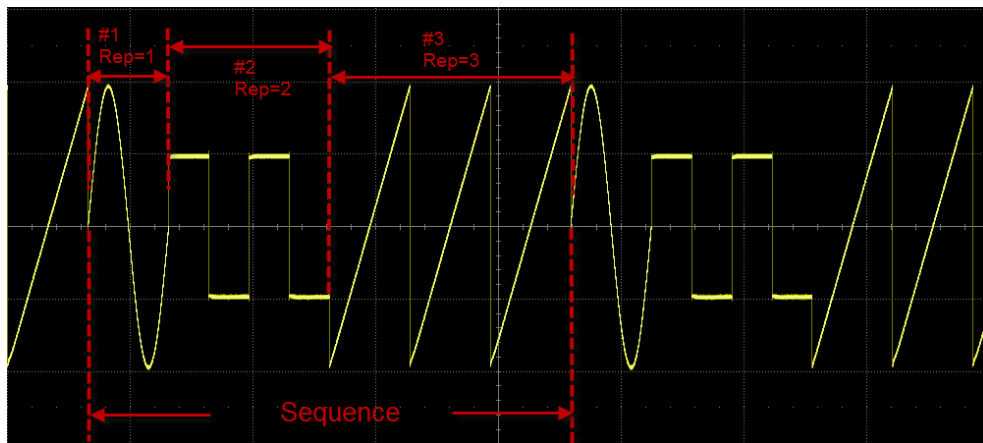

In sequence mode, the actual output amplitude is also affected by the amplitude percentage of the carrier setting interface. For example, if the amplitude set on the sequence page is 2 Vpp and the amplitude percentage on the carrier setting page is 50%, the actual output amplitude is 1 Vpp.

9.6 I/Q Setting

The SDG7000A can be used as an I/Q signal generator to provide I/Q vector signals with ASK, PSK, QAM, FSK, MSK, multi-tone, and other modulations. I/Q source can be generated with the PC software EasyIQ, which is connected with the device through USB or LAN.

When starting the I/Q function, the device needs to initialize the I/Q related configuration, which takes about 10 seconds. In I/Q mode, CH1 is used as I-channel output and CH2 is used as Q-channel output. The two outputs share a set of parameter settings, as shown in the following figure:

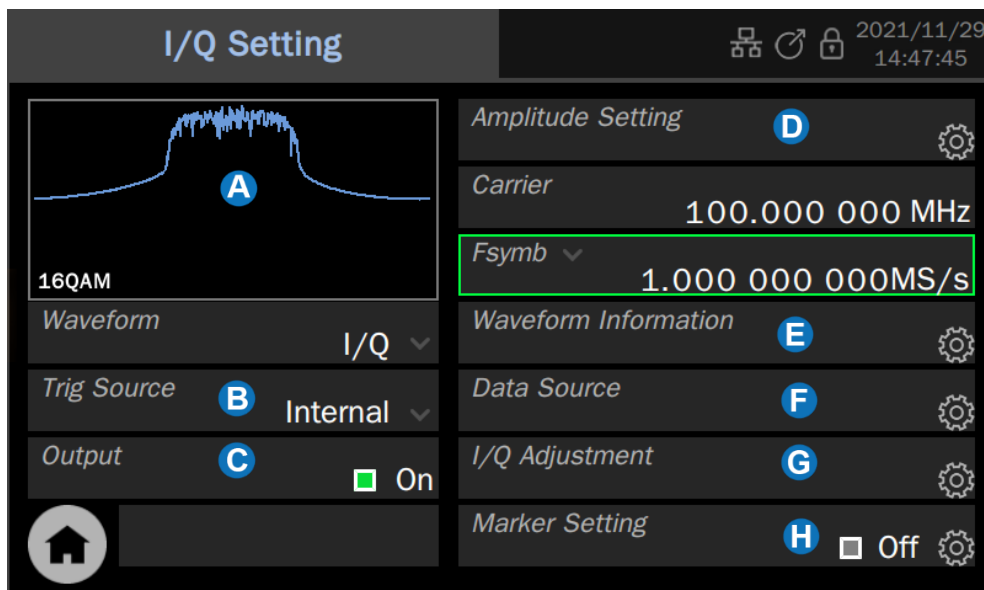

- A** Waveform spectrum preview
- B** Trigger source parameter setting box
- C** Output switch
- D** Waveform parameter setting area
- E** Waveform information
- F** Data source selection
- G** I/Q adjustment setting
- H** Marker setting

Waveform Parameter Setting

The waveform parameters of I/Q include "Carrier", "Amplitude Setting" and "Fsymb". The setting method refers to sine wave.

Table 9-14 I/Q waveform parameter description

I/Q	
Carrier	The frequency of the carrier. When the carrier frequency = 0, the output is baseband I/Q signal; When the carrier frequency $\neq 0$, the output is an IF (Intermediate Frequency) signal. Read the section "Working Mode" for the difference between the two.
Amplitude Setting	When the carrier frequency = 0, the amplitude value is the modulus of the I / Q signal $\sqrt{I^2 + Q^2}$. When the carrier frequency $\neq 0$, the signal is only output from I-channel, and the amplitude value is the root mean square value of I-channel output I_{rms} .
Fsymb /Fs	The symbol rate (Fsymb) and sample rate (Fs) are converted according to the parameter oversampling factor (Pts/symbol), and the conversion relationship: $F_s = f_{\text{symb}} * \text{Pts/symbol}$. The information of the oversampling factor can be read in "Waveform Information".

Waveform Information

The waveform information contains the modulation parameters of the waveform, including modulation type, symbol length, oversampling factor, filter type, and roll-off factor of the filter. It is read-only.

Waveform Info		2021/11/29 15:06:04
Symbol Length	1024	
Oversampling	4	
Modulation	16QAM	
Filter Type	RootCosine	
Filter Alpha	0.35	

Trigger Source

Trigger sources include Internal, External and Manual trigger.

Table 9-15 Description of I/Q waveform trigger source

Trigger source	Description
Internal	When the trigger source is internal, the IQ waveform is continuously output.
External	When the trigger source is external, the signal generator receives the trigger input from the rear panel and outputs a cycle of IQ waveform every time it receives a trigger edge of CMOS pulse.
Manual	When the trigger source is manual, a Trigger Button will appear on the parameter page and each time the button is pressed, the IQ signal will be output for one cycle.

Data Source

Click the setting icon  in the "Data Source" parameter setting box to enter the data source selection interface. You can choose to load the Built-In waveform or the saved waveform

Table 9-16 I/Q waveform data source description

Data Source	Description
Built-In	The built-in waveforms are a series of preset waveforms in the signal generator, including a variety of ASK, PSK, QAM, and other modulation waveforms. The selection method of Built-In waveform is the same as that of Arb.
From File	A saved waveform is the waveform file saved in the local directory or external USB flash disk by the user. The selection method of the saved waveform is the same as that of Arb.

9.6.1 Working Mode

The I/Q signal of the SDG7000A can be output in two modes. When the central frequency (carrier) = 0, the working mode is baseband I/Q. In this mode, CH1 is I-channel and CH2 is Q-channel.

When the central frequency \neq 0, the working mode is IF (Intermediate Frequency). In this mode, the I and Q data will be sent to the internal quadrature modulator and modulated to the carrier frequency before output. The output of the quadrature modulator is led out from CH1 after broadband compensation.

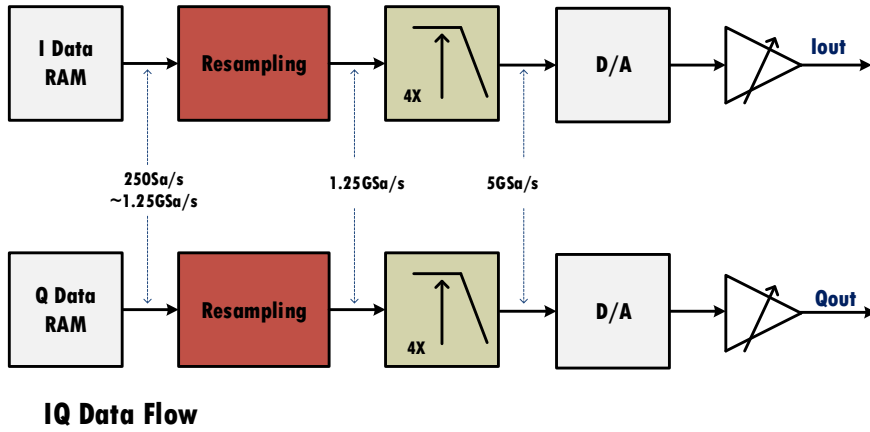

Figure 9-4 Baseband I/Q mode

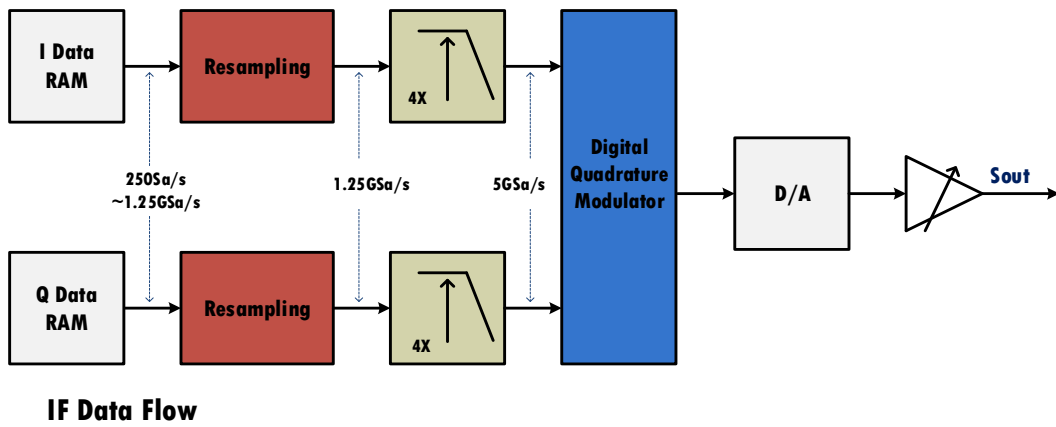

Figure 9-5 IF mode

The schematic block diagram of the internal quadrature modulator is shown in the figure below:

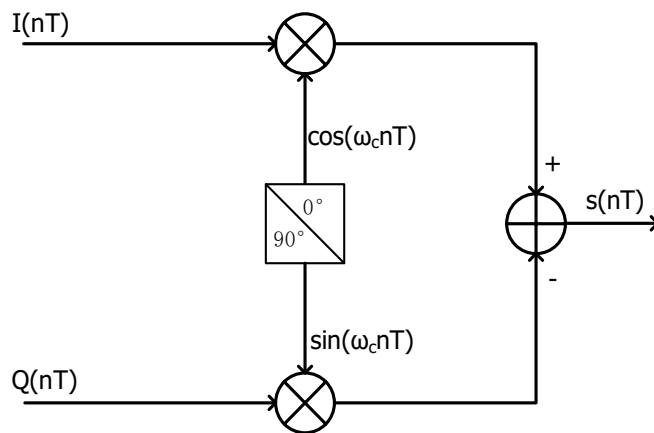

Figure 9-6 Schematic block diagram of quadrature modulator

9.6.2 I/Q Adjustment

In baseband I/Q mode, the SDG7000A provides the option of I/Q adjustment to suppress the image caused by the imbalance of I/Q channels to the greatest extent.

Table 9-17 Description of I / Q waveform data source

I/Q Adjustment	Description
Gain Balance	Amplitude gain balance, the amplitude difference between the two I/Q channels is adjustable, the unit is dB
I Offset	The I-channel DC offset is jointly adjusted with the Q-channel DC offset to compensate for the offset imbalance of the I/Q channels
Q Offset	Q-channel DC offset
Q Angle	The phase angle of the Q-channel is adjusted to compensate for the phase imbalance of the I / Q channels

9.6.3 EasyIQ

The I/Q signal editing PC software EasyIQ supports the generation of I/Q data of various modulation types such as 2ASK, 4ASK, 8ASK, BPSK, QPSK, 8PSK, DBPSK, DQPSK, D8PSK, 8QAM, 16QAM, 32QAM, 64QAM, 128QAM, 256QAM, 2FSK, 4FSK, 8FSK, 16FSK, MSK, multi-tone, etc., and can directly download the data to the device for output.

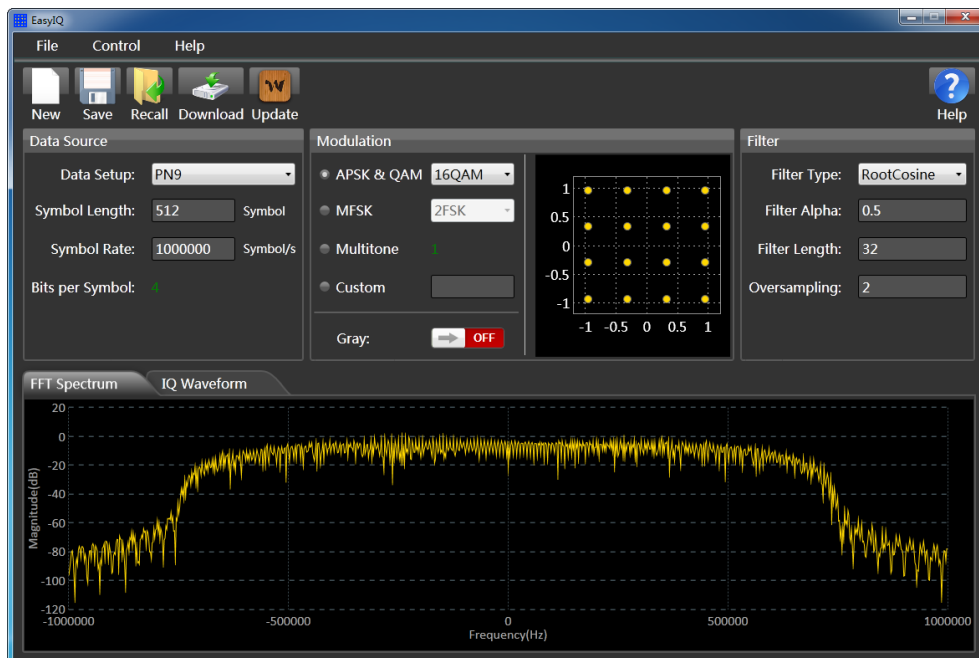

Figure 9-7 EasyIQ operation interface

For detailed instructions on the use of EasyIQ, please refer to the help of the software itself.



Application example: Use EasyIQ to generate a pair of I/Q signals, download it to the SDG7000A, modulate the I/Q signals to 100 MHz carrier, and observe the IF output. The parameters of the I/Q signals are as follows:

- Modulation = 16QAM
 - Symbol = 1024
 - F_{symb} = 10 MSymbol/s
 - Oversampling = 4
 - Filter Type = RootCosine; Filter Alpha = 0.35
1. Connect the computer with the SDG7000A through the USB cable provided with the SDG7000A.
 2. Set the "Waveform" of the SDG7000A to "I/Q".
 3. Start EasyIQ software on the PC, set "Modulation" to "16QAM", "Symbol Length" to 1024 symbol, "Symbol Rate" to 10000000 symbol/s, "Filter Type" to "RootCosine", "Filter Alpha" to 0.35, and "Oversampling" to 4. The user interface after setting is shown in the following figure:



4. Click "Download" in the toolbar of EasyIQ, and select the device number corresponding to the SDG7000A in the available "VISA Address" list:

```

USB0::0xF4EC::0x1102::SDG7ABAX5R0006::INSTR
TCPIP0::K-E5080A-00263::hislip0::INSTR
TCPIP0::K-E5080A-00263::inst0::INSTR
TCPIP0::K-E5080A-00263::5025::SOCKET
ASRL1::INSTR
ASRL3::INSTR
ASRL10::INSTR
LOCALHOST
  
```

- Click "Download" in the dialog box to complete the waveform download.

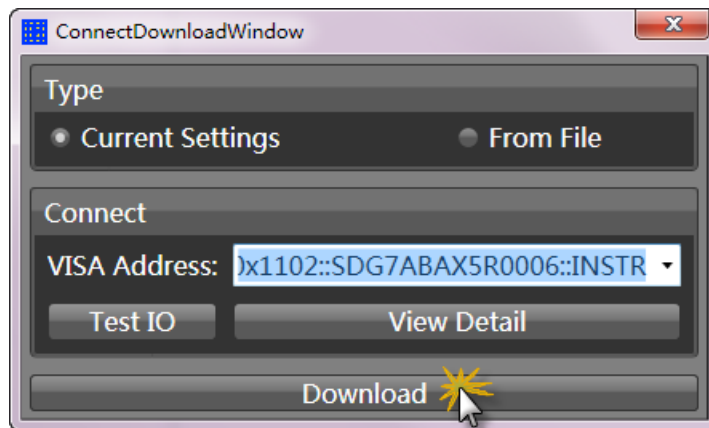

- Set the "Carrier" frequency to 100 MHz on the SDG7000A
- Connect the "+" terminal of CH1 of the SDG7000A to the signal analyzer for demodulation, and the results are as follows:

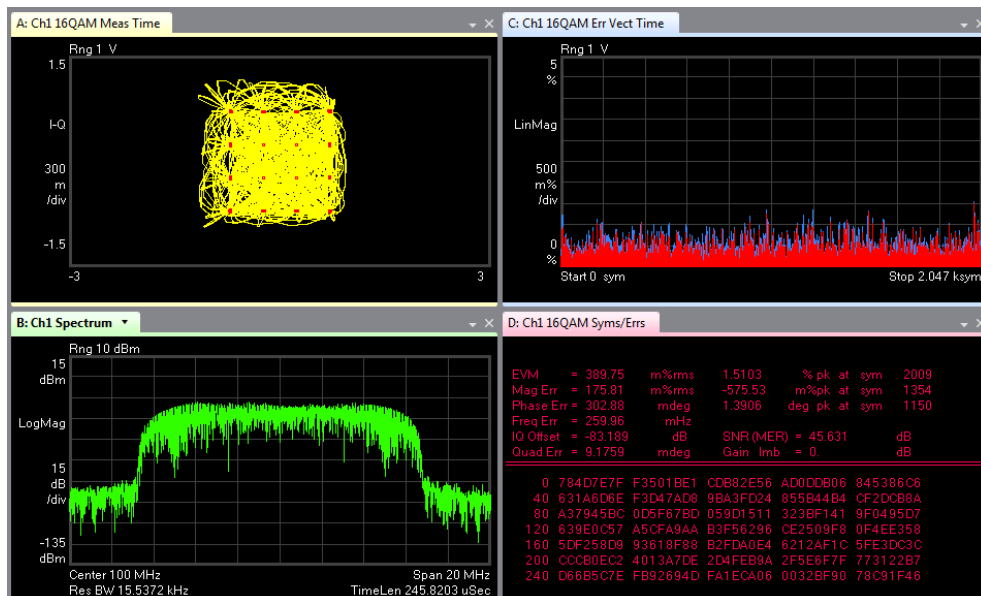

If the computer and SDG7000A are connected through a network, enter the network IP of the SDG7000A device directly in the "visa address" area to communicate. Read "LAN Settings" for network IP settings.

10 Modulation/Sweep/Burst Settings

10.1 Overview

Modulation, Sweep, and Burst can all be seen as modulation of the carrier. In addition to conventional modulation, a sweep is a special type of frequency modulation and a burst is a type of pulse modulation.

Click on the parameter display area of the modulation/sweep/pulse setting block corresponding to the channel on the home page (left below), or click on the setting icon  in the "Mod" setting box on the carrier parameter setting page (right below) to enter the modulation/sweep/burst setting page for the corresponding channel.



Clicking in the Mod, Sweep or Burst switch area of the Modulation/Sweep/Burst setting block allows you to quickly turn the corresponding function on/off.

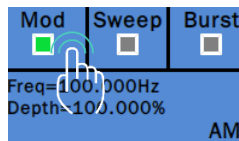

On the carrier settings page, click on the parameter selection area in the "Mod" setting box to quickly select Mod, Sweep or Burst (left below), and click on the switch to the right of the parameter area to quickly turn the selected function on/off (right below).

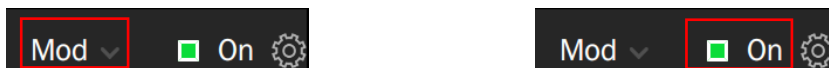

10.2 Modulation

The SDG7000A supports usual standard analog modulations (AM/DSB-SC/FM/PM/PWM etc.) and digital keying (ASK/FSK/PSK etc.). The modulation source can be selected from internal, external, and channel.

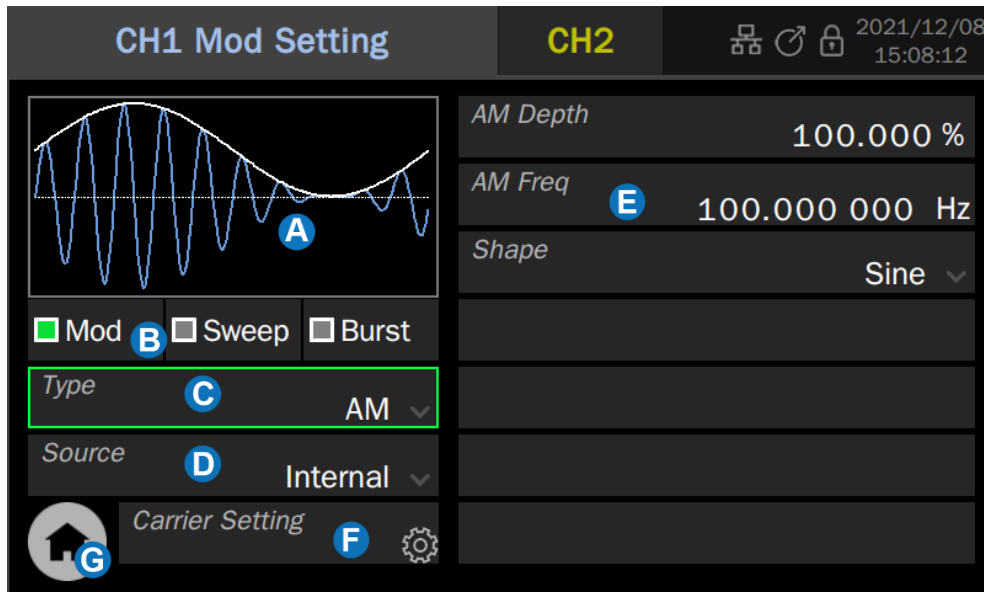

- A** Waveform preview
- B** **Mod/Sweep/Burst quick setting:** Click any one of the three to quickly switch to the corresponding function and open its parameter setting page
- C** **Modulation type selection:** Click the modulation type parameter area on the right to select the modulation type
- D** **Modulation source selection:** Select the modulation source, as internal, external or another channel.
- E** **Modulation parameter setting area:** The parameters of each modulation are different. The page will automatically switch to the corresponding parameter settings according to the selected modulation type
- F** Quickly switch to carrier parameter setting page
- G** Return to the Home Page

10.2.1 Source Selection

There are 3 types of sources for modulating signals: Internal, external, and channel. A detailed description is given in the following table.

Table 10-1 Modulated waveform sources and descriptions

Source	Description
Internal	The modulation signal is generated internally from the DDS module according to the user's configuration (modulation frequency, modulation waveform), etc.
External	<p>The modulation signal is external.</p> <p>When the modulation type is analog modulation (AMB/DSB-SC/FM/PM/PWM etc.), the external source is fed from the external modulation interface on the rear panel. The amplitude of the input analog signal determines the modulation factor (modulation depth/frequency deviation /phase deviation etc.).</p> <p>The requirements for the external modulation amplitude are described in detail in the datasheet parameter "Amplitude at 100% modulation". See Table 10.2 for a description of the 100% modulation.</p> <p>When the modulation type is digital keying modulation (ASK/FSK/PSK etc.), the external source is input from the trigger interface on the rear panel.</p> <p>The input digital sequence must meet the electrical requirements of the trigger input (see datasheet for details)</p>
Channel	When the carrier is CH1, CH2 can be directly used as the modulating waveform. In this case, the device directly uses CH2 to modulate CH1 internally without introducing the waveform of CH2 to the external modulation interface through an external cable. Vice versa.

Table 10-2 Description of 100% modulation

	Description
AM	Corresponds to the case where modulation depth = 100%
FM	100% modulation is equal to the set frequency deviation. For example, if the amplitude of the external modulation input is 50% of the corresponding amplitude when 100% modulation is selected, the resulting frequency deviation is 50% of the set frequency deviation.
PM	100% modulation is equal to the set phase deviation. For example, if the amplitude of the external modulation input is 50% of the corresponding amplitude when 100% modulation is selected, the resulting phase deviation is 50% of the set phase deviation.

10.2.2 Modulation Type

The following table shows the various modulation types supported by the SDG7000A and their compatibility with carriers.

Table 10-3 Compatibility of modulation types with carriers

Carrier \ Modulation	Sine	Square	Pulse	Ramp	Noise	AFG	AWG
AM	●	●	●	●	●	●	●
DSB-SC	●	●	●	●	●	●	●
FM	●	●		●		●	
PM	●	●		●		●	
PWM			●				
FSK	●	●		●		●	
ASK	●	●	●	●	●	●	●
PSK	●	●		●		●	

AM

AM is amplitude modulation, a modulation method that uses the amplitude of the modulating waveform to control the amplitude of the carrier.

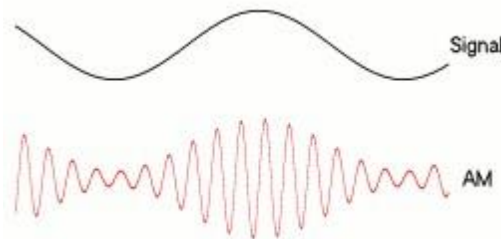

The parameters that can be set for AM are listed in the table below.

Table 10-4 Description of AM modulation parameters

AM	
Modulation depth	<p>Also known as amplitude modulation factor (m), determined by the maximum and minimum amplitude of the envelope:</p> $m = \frac{U_{cm,max} - U_{cm,min}}{U_{cm,max} + U_{cm,min}}$ <p>When source = internal or channel, this value can be set directly. When source = external, it is determined by the amplitude of the external modulation input.</p>

<p>AM frequency</p>	<p>The frequency of the modulating waveform. When source = internal, the value can be set directly. When source = external or channel, it is determined by the frequency of the external modulation input or another channel.</p>
<p>Shape</p>	<p>The shape of the modulating waveform. When source = internal, the value can be set directly. When source = external or channel, it is determined by the external modulation input or the waveform of another channel.</p>

The AM amplitude strategy is to keep the power of the carrier the same as when it is unmodulated, i.e.: the power of the carrier is independent of the modulation depth. This will result in the AM waveform peaking beyond the set value, which is normal. The figure below shows a comparison of the amplitude of a 100 MHz, 0 dBm carrier with no modulation and at 100% modulation depth, and it can be seen that the peaks in the time domain become larger when modulation is turned on, but the power of the carrier remains the same in the frequency domain.

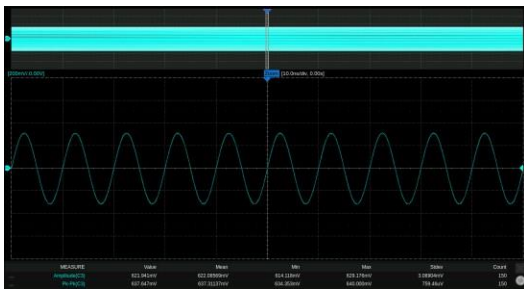

Unmodulated time-domain diagram

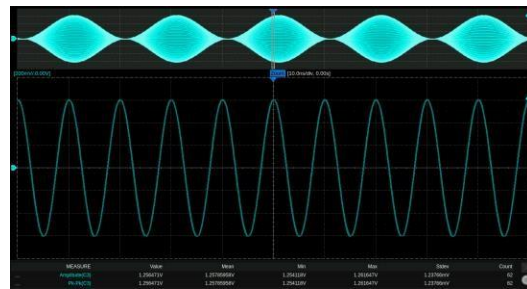

100% modulation depth time-domain diagram

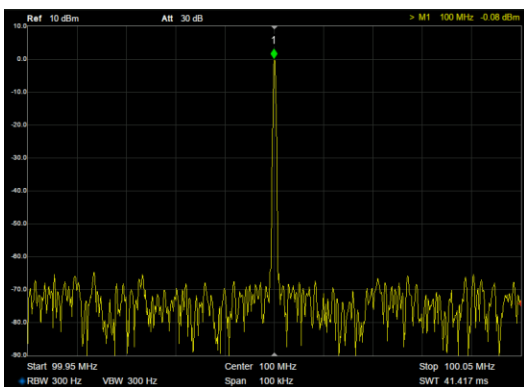

Unmodulated Spectrogram

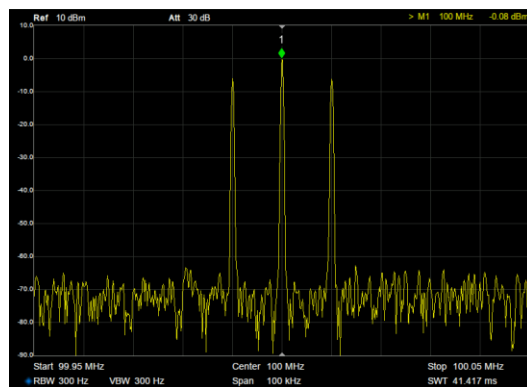

100% Modulation Depth Spectrogram

DSB-SC

DSB-SC is double-side-band amplitude modulation with suppressed carrier.

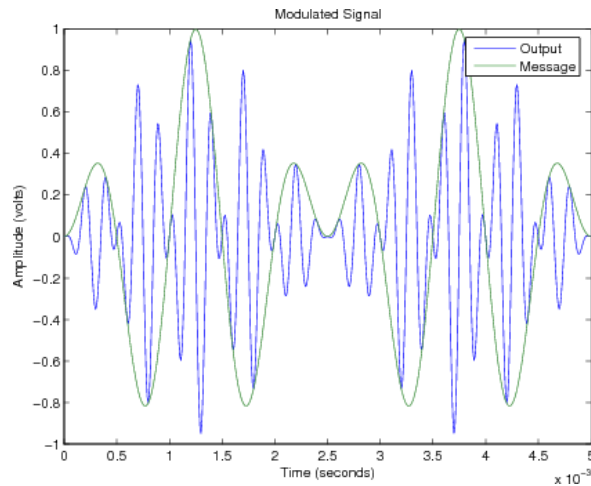

The configurable parameters of the DSB-SC are listed in the table below.

Table 10-5 Description of DSB-SC modulation parameters

DSB-SC	
Modulation	Same as AM
DSB frequency	Same as AM
Shape	Same as AM

FM

FM is frequency modulation, a modulation method that uses the amplitude of the modulating waveform to control the frequency of the carrier.

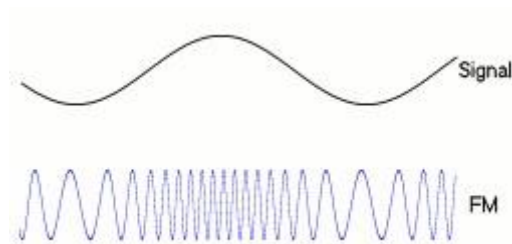

The parameters that can be set for FM are listed in the table below.

Table 10-6 Description of FM modulation parameters

FM	
FM frequency	Same as AM
Shape	Same as AM

<p>Frequency deviation</p>	<p>The maximum value Δf of the instantaneous frequency deviation from the carrier frequency f_c, which corresponds to the maximum or minimum value of the modulating waveform amplitude when the frequency deviation is reached. The modulated carrier frequency varies in the range $f_c \pm \Delta f$</p> <p>When source is internal or channel, this value can be set directly.</p> <p>When source is external, modulated by external. The full amplitude of the external modulation waveform corresponds to the set frequency deviation.</p>
----------------------------	---

PM

PM is phase modulation, a modulation method that uses the amplitude of the modulating waveform to control the instantaneous phase of the carrier.

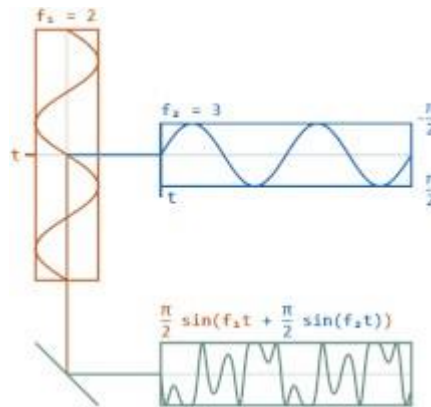

The parameters that can be set for PM are listed in the table below.

Table 10-7 Description of PM modulation parameters

PM	
PM Frequency	Same as AM
Shape	Same as AM
Phase deviation	<p>The maximum value $\Delta\phi$ of the instantaneous phase deviation from the instantaneous phase $\phi_c(t)$ when the carrier is not modulated. The maximum phase deviation corresponds to the maximum or minimum value of the modulating waveform amplitude. The phase of the modulated waveform is at varies over a range of</p> <p>$\phi_c(t) \pm \Delta\phi$</p> <p>When the source is internal or channel, the value can be set directly; when the source is external, it is determined by the amplitude of the external modulation input. The full amplitude of the external modulation waveform corresponds to the set phase deviation.</p>

PWM

PWM, pulse width modulation, is only applicable when the carrier is pulse and refers to the modulation method where the amplitude of the modulating waveform is used to control the positive pulse width of the carrier.

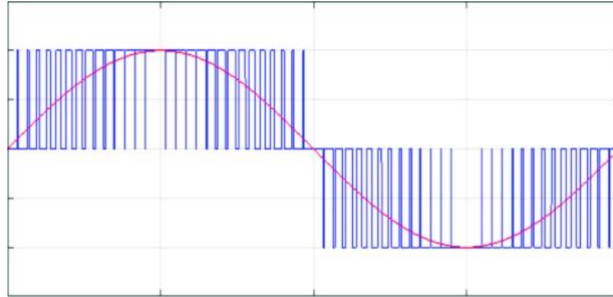

The parameters that can be set for the PWM are listed in the table below.

Table 10-8 Description of PWM Modulation Parameters

PWM	
PWM frequency	Same as AM
Shape	Same as AM
Pulse width deviation	<p>The maximum deviation of the positive pulse width from the positive pulse width without modulation corresponds to the maximum or minimum value of the modulating waveform amplitude.</p> <p>When the source is internal or channel, this value can be set directly.</p> <p>When the source is external, modulated by external</p> <p>The full amplitude of the external modulation waveform corresponds to the set pulse width deviation.</p>

ASK

ASK is amplitude shift keying, here refers to binary amplitude keying. The amplitude of the carrier being modulated varies with the 1/0 state of the binary sequence, i.e. the presence or absence of the carrier amplitude is used to represent a 1 or a 0.

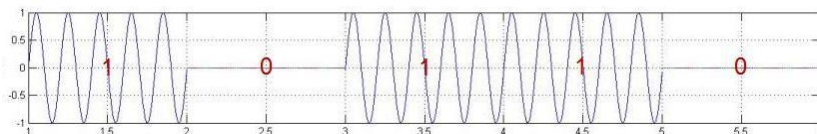

The parameters that can be set for ASK are listed in the table below.

Table 10-9 ASK parameter descriptions

ASK	
Keying frequency	<p>The rate of the binary sequence. This value can be set directly when the source = internal and the internal source is a clock sequence with the specified frequency multiplied by 2. When the source = external, the</p>

	amplitude of the carrier is determined by the 0/1 state of the external trigger input
--	---

FSK

FSK is frequency keying, here refers to binary frequency shift keying. The frequency of the modulated carrier varies with the 1/0 state of the binary sequence, i.e. a carrier frequency of f_0 means that 0 is transmitted and a carrier frequency of f_1 means that 1 is transmitted.

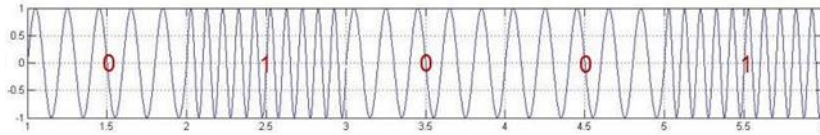

The parameters that can be set for FSK are listed in the table below.

Table 10-10 FSK parameter descriptions

FSK	
Keying frequency	Same as ASK
Frequency hopping frequency	The frequency representing 1, i.e. f_1 . The frequency representing 0 (i.e. f_0) is the currently set carrier frequency

PSK

PSK is phase shift keying, here refers to binary phase shift keying. The instantaneous phase of the carrier being modulated varies with the 1/0 state of the binary sequence.

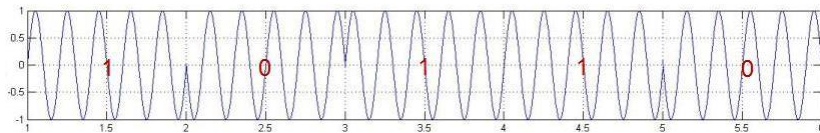

The parameters that can be set for PSK are listed in the table below.

Table 10-11 PSK parameter descriptions

PSK	
Keying rate	Same as ASK
Polarity	Positive phase/inverted phase. In positive phase, the phase is 0° when varying from 0 to 1 and 180° when 1 to 0. Opposite when inverted



Application example: Generate an FM waveform with an internal modulation source and the following parameters

- Carrier waveform = Sine, frequency = 120 MHz
 - Modulating waveform = triangle, frequency = 1 MHz, frequency deviation = 10 MHz
1. Set "Waveform" of the carrier to Sine and "Frequency" to 120 MHz in the parameter setting page of the carrier
 2. Click on the settings icon  in the Modulation/Sweep/Burst settings box at the bottom left of the page to enter the interface for modulation/sweep/burst settings
 3. Set "Mod" to "On"
 4. Set "Type" to "FM"
 5. Set "Source" to "Internal"
 6. Set the "FM Freq" to 1 MHz
 7. Set "Freq Dev" to 10 MHz
 8. Set "Shape" to "Triangle"
 9. Open the output

Follow the above steps to generate the desired FM waveform. The modulation parameters page is as below:

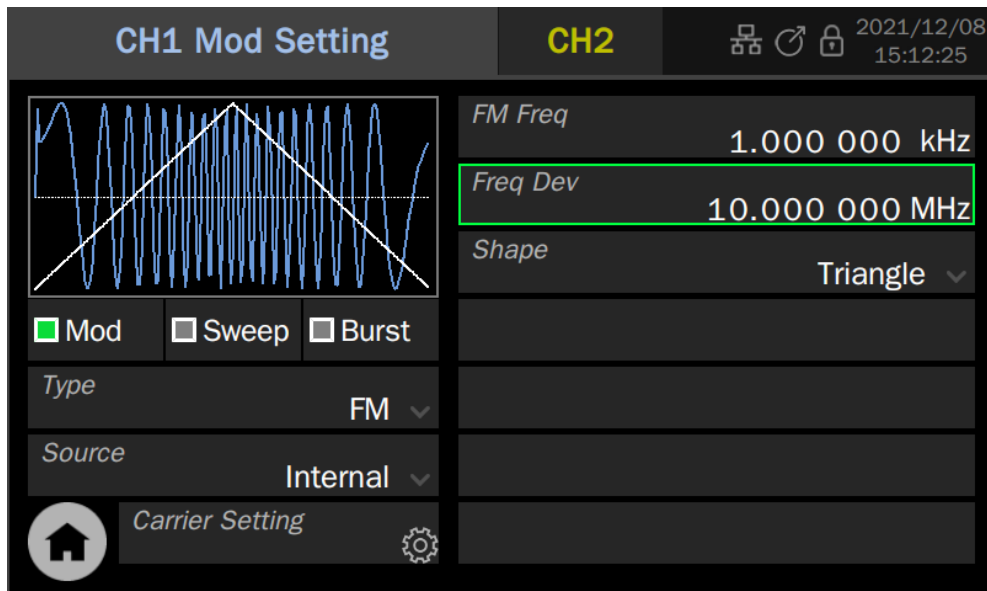

The time and frequency domain plots of the FM waveform output are as follows:

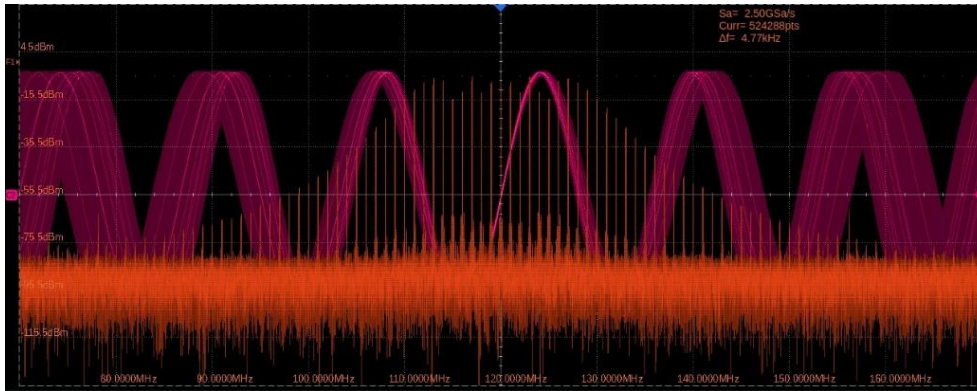

Frequency measurements were taken on the modulated signal and the frequency versus time (Tracking diagram) was plotted as below, reflecting the frequency versus modulating shape characteristics of the modulated waveform.

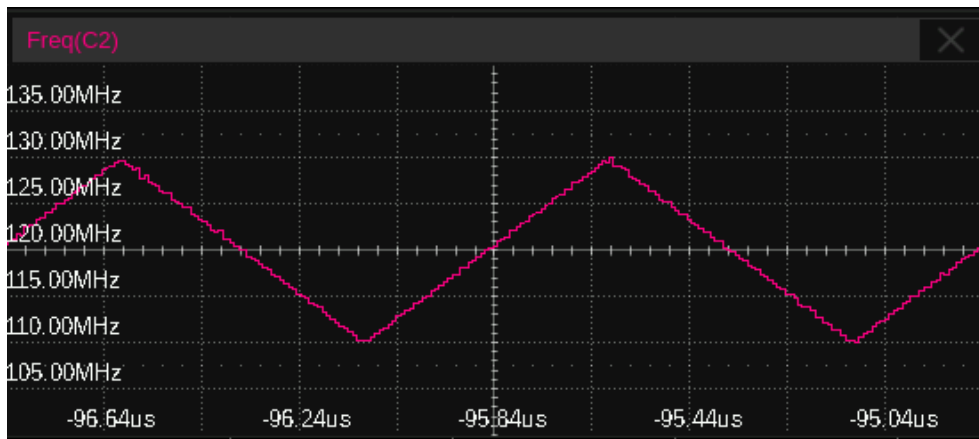

Application example: Generate an AM waveform with an external source and the following parameters

- Carrier waveform = Sine, frequency = 20 kHz
 - Modulating waveform = Sine, frequency = 1 kHz, modulation depth = 50%
1. Set "Waveform" of the carrier to Sine and "Frequency" to 20 kHz in the parameter setting page of the carrier.
 2. Enter the modulation/sweep/burst setting interface and set "Mod" to "On"
 3. Set "Type" to "AM"
 4. Set "Source" to "External", set the waveform of the external modulation input to Sine and frequency to 1 kHz, and consult the data sheet for the external input amplitude of $\pm 5\text{V}$ pk-pk, which corresponds to 100% modulation. The amplitude of the external modulation signal is therefore set to $\pm 2.5\text{V}$ pk-pk, which gives a modulation depth of 50%. The external modulation signal can be provided by another source or by another channel of the unit.
 5. Open the output

Follow the above steps to generate the desired FM waveform. The modulation parameters page after the setup is shown below. Note that since the modulating waveform frequency, shape, and modulation depth are entirely determined by the external modulating input, the relevant parameters are not displayed on the setup page.

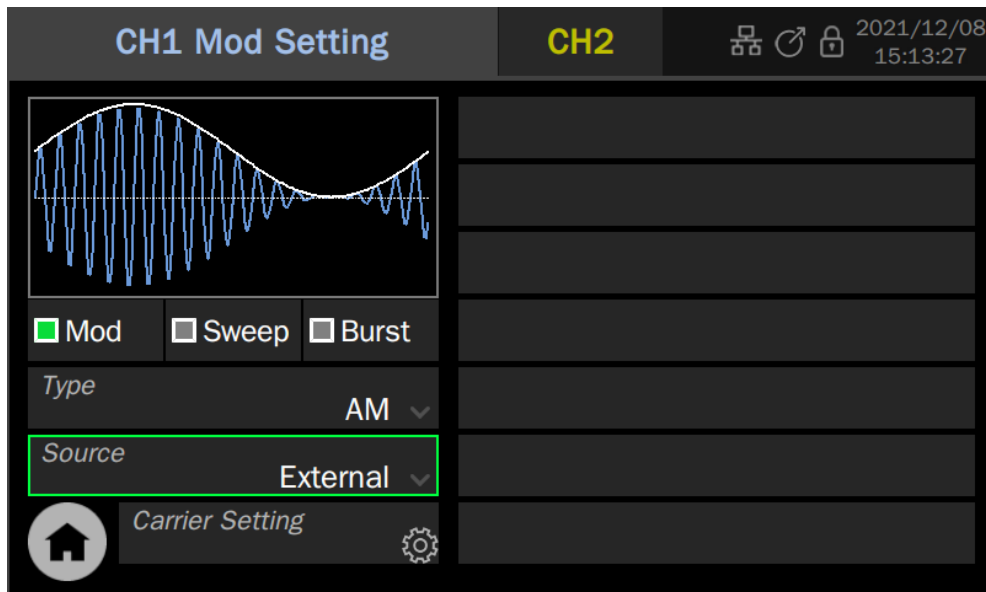

The waveform of the AM output is as follows: (red trace. The green trace is the modulating waveform).

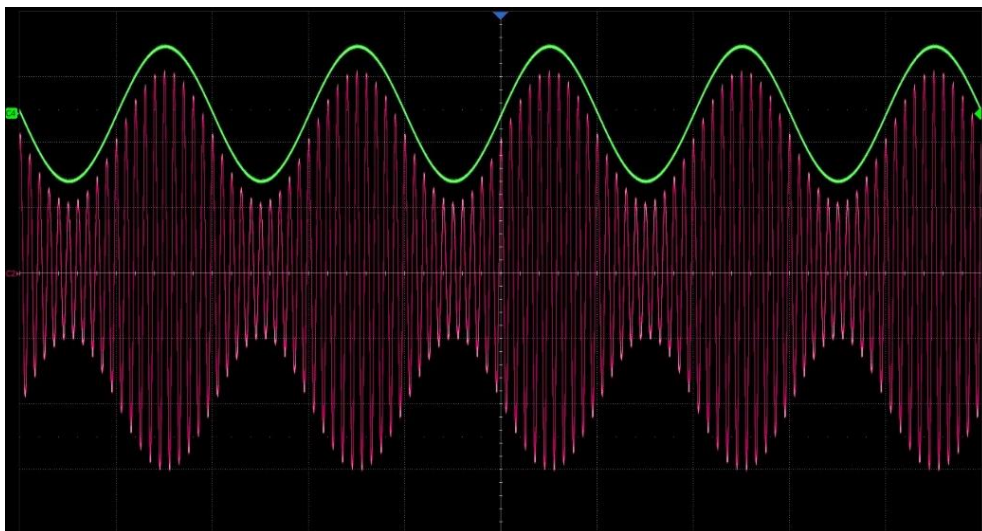

Application example: Generate a PWM waveform with another channel as the modulation source, with the following parameters

- Carrier frequency = 1 MHz, pulse width = 500 ns
 - Modulating waveform = Sine, frequency = 100 kHz, pulse width deviation = 400 ns
1. PWM modulation is only supported when the carrier is Pulse. Set the carrier to Pulse and the frequency to 1 MHz on the parameter setting page of the carrier

2. Enter the modulation/sweep/burst setting interface and set "Mod" to "On"
3. Set "Type" to "PWM" and the pulse width deviation to 400 ns
4. Set "Source" to "CH2"
5. Set "Waveform" of CH2 to Sine and "Frequency" to 100 kHz.
6. Turn on the outputs of CH1 and CH2

Follow the above steps to generate the desired PWM waveform. The modulation parameters page of CH1 after setup is as below:

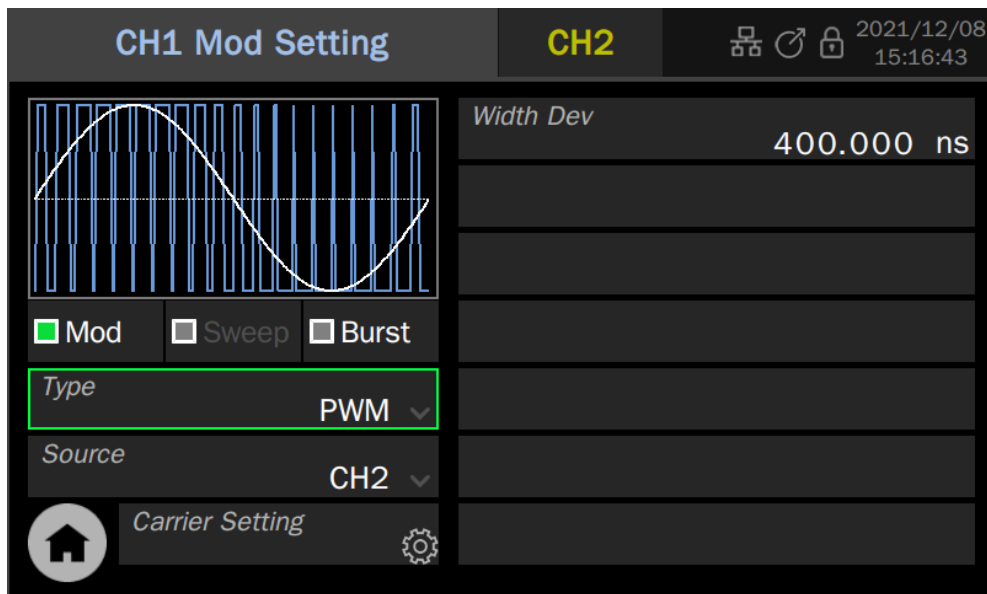

The waveform of the PWM output is as follows: (red trace. The green trace is the modulated waveform).

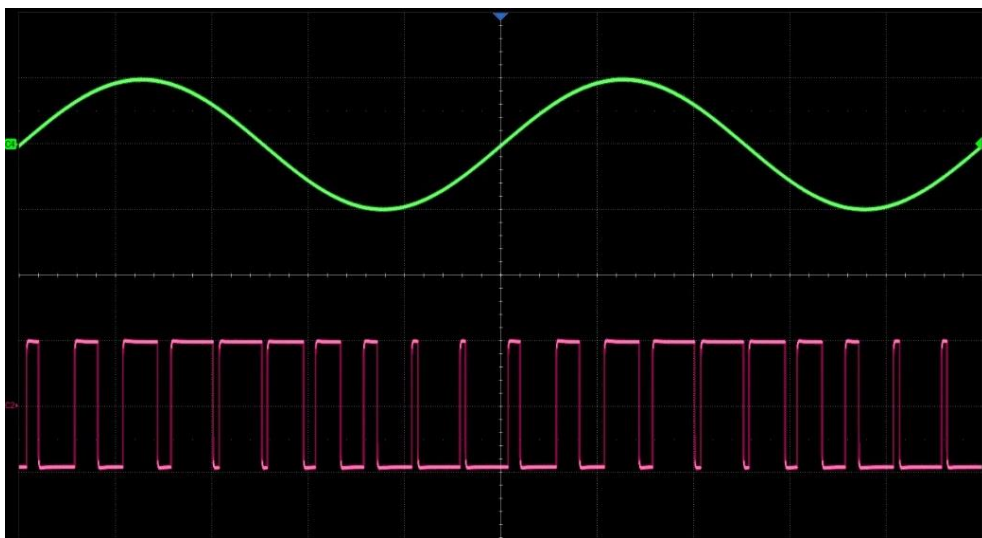

In both this example and the previous example, CH2 is used as the modulation source and CH1 as the carrier. The difference is that in the previous example the output of CH2 has to be

connected to the external modulation input of the device via a cable, whereas in this example the modulating waveform and modulates the carrier directly inside the device without any external connection.



For the modulation to take effect, the channel that is the source of the modulation needs to be enabled.

10.3 Sweep

Sweep is a special type of frequency modulation (FM) or amplitude modulation (AM). When the sweep is on, the carrier output frequency or amplitude can be varied according to a set rhythm (linear/logarithmic/step) and can be controlled by a trigger signal.

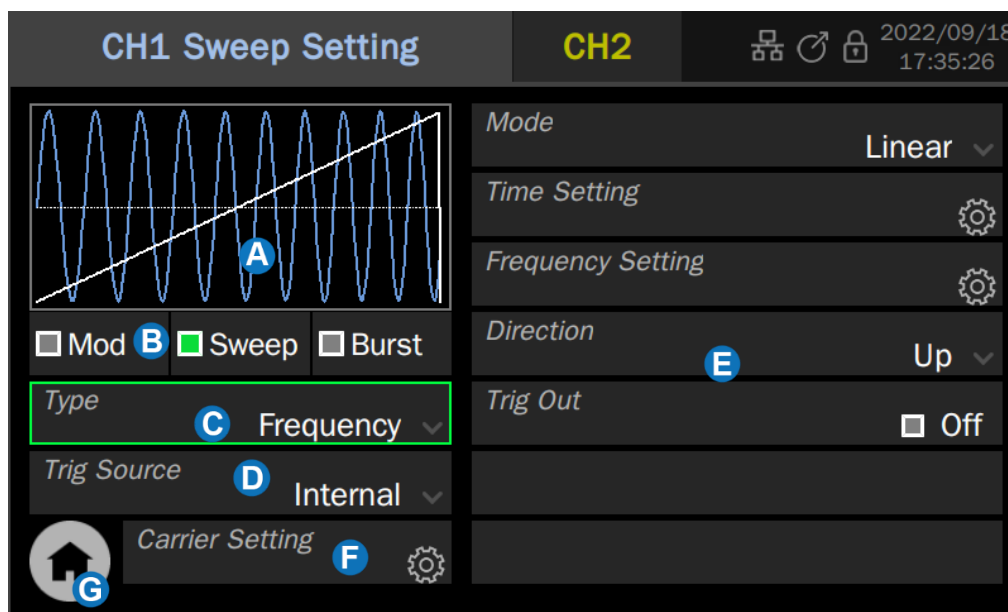

- A** Waveform Preview
- B** Mod/Sweep/Burst quick setting
- C** Sweep type setting
- D** Trigger source selection
- E** Sweep parameter setting area
- F** Quickly switch to carrier parameter setting page
- G** Return to the Home Page

10.3.1 Sweep Type

There are two sweep types, frequency, amplitude and freq&l, as detailed in the following table.

Table 10-12 Types of sweeps

Sweep Type	Description
Frequency	A special frequency modulation (FM)
Amplitude	A special amplitude modulation (AM)
Freq&Ampl	Frequency modulation and amplitude modulation

10.3.2 Sweep Mode

There are two sweep modes, linear, logarithmic and step, as detailed in the following table.

Table 10-13 Modes of sweeps

Sweep Type	Description
Linear	This means that the modulating waveform is a sawtooth, which controls the frequency moves from the start frequency to the stop frequency following Linear variation
Log	The frequency variation follows a 10^x law and is often used for frequency response testing. The frequency response is generally plotted in logarithmic coordinates (10 octaves), so to see the frequency response in a logarithmic plot, a uniform distribution of sample points requires the use of a logarithmic sweep (Only frequency sweep is supported)
Step	The output signal frequency varies in a stepped manner from the start frequency to the end frequency. The frequency points are controlled by the "Step Number".

10.3.3 Trigger Source

The three trigger sources used for sweep are internal, external, and manual and are described in detail in the following table.

Table 10-14 Trigger sources for frequency sweep

Trigger source	Description
----------------	-------------

Internal	The sweep cycle is controlled by the internal timer
External	<p>The signal generator receives the trigger input on the rear panel and outputs a frequency sweep every time it receives the trigger edge(rising or falling edge determined by the edge setting) of a CMOS pulse.</p> <p>When the trigger signal arrives, the signal generator outputs the carrier of the start frequency. After the start hold time, it starts sweeping. The frequency changes from the start frequency to the stop frequency then maintains the stop frequency until the end hold time has expired. Then it outputs the offset value, and starts frequency sweeping again after the back time has expired.</p>
Manual	<p>When the trigger source is manual, a trigger button will appear on the parameter page, and the frequency sweep will be output every time the button is pressed.</p> <p>When the trigger signal arrives, the signal generator outputs the carrier of the start frequency. After the start hold time, it starts sweeping, the frequency changes from the start frequency to the stop frequency, then maintains the stop frequency for the end hold time. And then outputs the offset value, and starts frequency sweeping again after the back time has expired.</p>

10.3.4 Sweep Parameter Settings

The sweep parameters and their detailed descriptions are shown in the following table.

Table 10-15 Parameters and description of the sweep

Scanning parameters	Description
Sweep time	The time spent from the start frequency sweep to the stop frequency. (So is amplitude sweep)
Start Hold Time	The time that the output signal maintains the starting frequency before sweeping. (So is amplitude sweep)
End Hold Time	The time that the output signal maintains the stop frequency after finishing sweeping. (So is amplitude sweep)
Back Time	After end hold time, the device outputs the offset value and stays in this status for back time, and then restart sweep. (So is amplitude sweep)
Start Freq / Center Frequency	The frequency parameter of the sweep. The relationships are as follows: Center frequency = (start frequency + stop frequency)/2
Stop Freq / Freq Span	Frequency span = stop frequency - start frequency (So is the amplitude parameter of amplitude sweep)

Sweep direction	<p>There are three modes: "Up", "Down", and "Up and Down".</p> <p>Up means that the frequency is swept from low to high; Down means that the frequency is swept from high to low; Up and Down mode is only applicable to linear sweep, where the frequency is first swept from the start frequency to the stop frequency and then back to the start frequency. This mode is equivalent to FM with a triangular waveform as the modulating source</p> <p>The symmetry of the sweep cycle can be set (So is the amplitude parameter of amplitude sweep)</p>
Trigger output	<p>When the trigger source = internal or manual, the trigger signal can be output from the trigger output on the rear panel.</p> <p>The trigger edge corresponds to the start of the scan</p>
Freq Marking	<p>The marker from the Marker port on the rear panel is synchronized with the specified frequency. Click on the  to set the marker frequency</p>

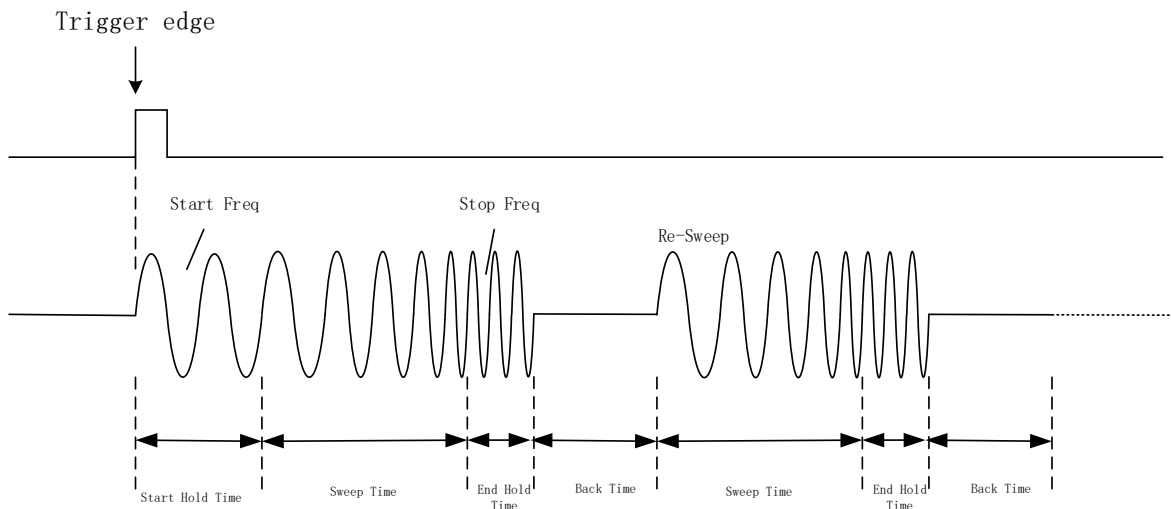

Figure 10-1 Sweep time description



Application example: A sine wave is output with linear and logarithmic sweeps respectively, with the following parameters

- Sweep direction = Upward, start frequency = 100 Hz, stop frequency = 100 kHz
- Sweep time = 3 ms
- Trigger source = internal, trigger output = on

1. Set the carrier "waveform" to "Sine" in the CH1 carrier parameter setting page
2. Enter the modulation/sweep/burst settings and set "Sweep" to "On"

3. Set "Type" to "Linear"
4. Set "Source" to "Internal"
5. Set "Sweep Time" to 3 ms
6. Set "Start Hold Time", "End Hold Time", "Back Time" to 0 s
7. Set "Direction" to "Up"
8. Set "Start Freq" to 100 Hz and the "Stop Freq" to 100 kHz
9. Turn on the trigger output. Use the rising edge of the trigger output to synchronize with the start frequency and use it to trigger the oscilloscope to observe a stable sweep signal
10. Turn on the output of CH1 and observe the result
11. Change the "Type" to "Log" and observe the results

Follow these steps to generate the desired sweep signal. Once set up the linear sweep parameters page is as follows. The parameters for the logarithmic sweep differ only in the "Type" field.

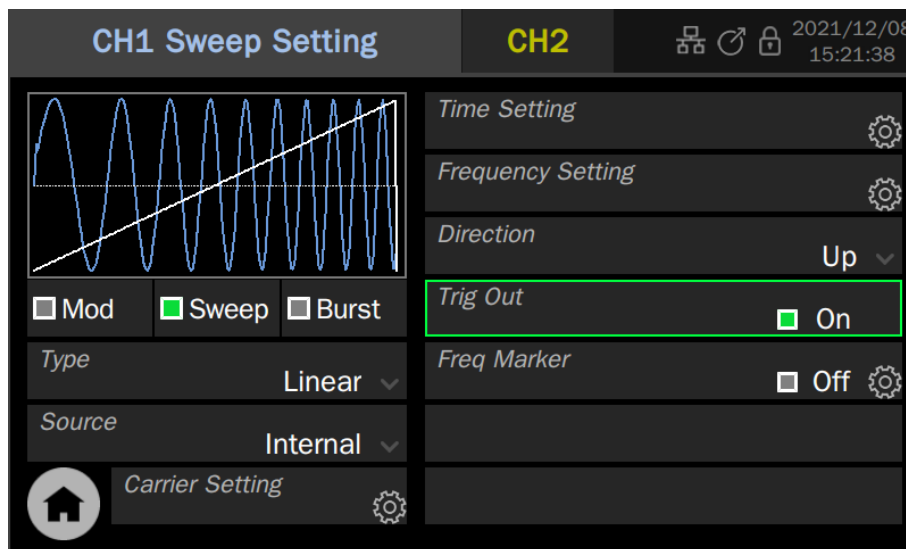

The results of the sweep output are as follows: (red traces are sweep signals, blue traces are trigger signals).

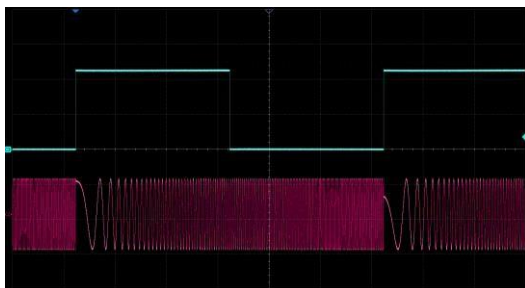

Linear sweep

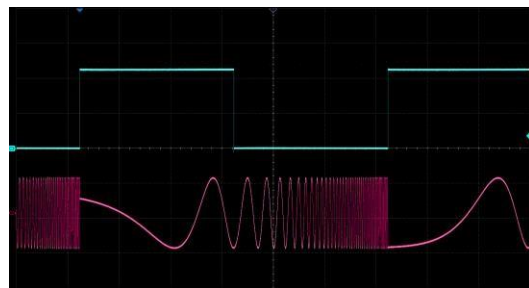

Log sweep

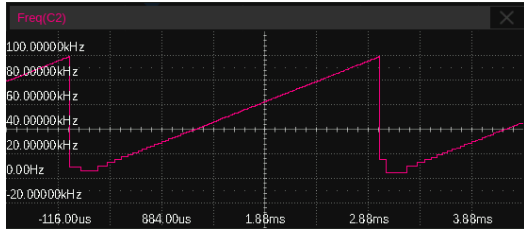

Linear sweep frequency vs. time

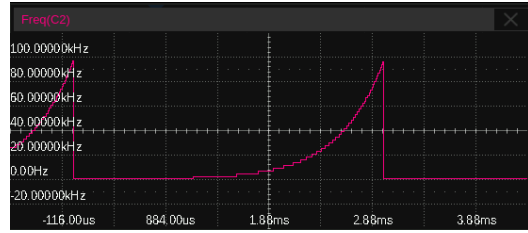

Log sweep frequency vs. time

This example will help the users to better understand the difference between a linear sweep and a logarithmic sweep: scanning from 100 Hz to 100 kHz with a sweep time of 3 ms increases the frequency by a factor of 10^3 and by a factor of 10 for every 1 ms in a logarithmic sweep. The table below shows the frequency values corresponding to each time point in logarithmic and linear sweep mode.

Time (ms)	0	1	2	3
Frequency (Hz) -- Logarithmic sweep	100	1000	10000	100000
Frequency (Hz) -- Linear sweep	100	33400	66700	100000

10.4 Burst

Burst is a signal train with several cycles. The burst train can be triggered by internal, external, or manual triggers.

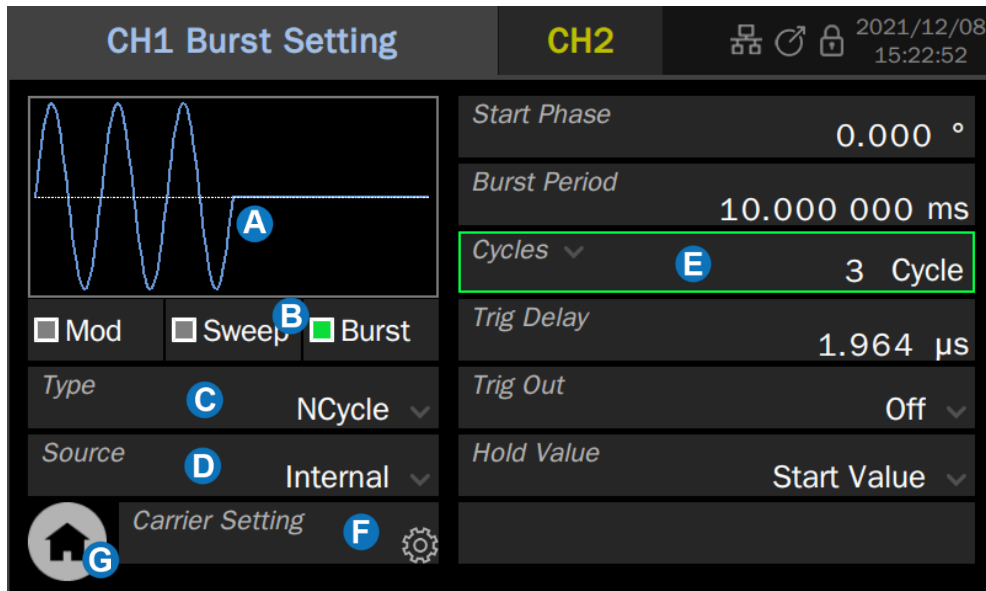

- A** Waveform Preview
- B** Mod/Sweep/Burst quick setting
- C** Burst type setting
- D** Trigger source selection
- E** Burst parameter setting area
- F** Quickly switch to the carrier parameter setting page
- G** Return to the Home Page

10.4.1 Burst type

There are two burst types: NCycle and Gated. They are described in detail in the following table.

Table 10-16 Types of Burst

Burst type	Description
NCycle	Outputs a specified number (N) of carrier cycles.
Gated	The carrier outputs only if the gating signal is valid. The gating signal can be active high or active low.

10.4.2 Trigger Source

Burst uses three kinds of trigger sources: internal, external, and manual. The use method is similar to frequency sweep. See the following table for details.

Table 10-17 Trigger sources for Burst

Trigger source	Description
Internal	The burst train output is controlled by an internal timer.
External	The generator receives the trigger/gating signal from the rear panel of the instrument. When used as a trigger signal, each time a trigger edge of a CMOS pulse is received, a burst signal is output. When used as a gating signal, the high or low level of the signal is used to determine whether or not to output the carrier.
Manual	When triggering manually, a trigger button will appear in the parameter setting area and each press of this button will trigger one burst.

10.4.3 Burst Parameter Setting

Burst parameters and their detailed descriptions are shown in the following table.

Table 10-18 Parameters and description of Burst

Burst parameters	Description
Start phase	Initial phase at the start of the burst
Burst Period	This parameter is used to set the period of the burst signal (i.e. time interval between burst trains).
Cycles	This parameter is only available when Burst type = N cycles and is used to specify the number of periods each burst contains. The number of periods can be set to "infinite" by clicking on the parameter name field of the parameter setting box, indicating that a continuous carrier will be the output after the trigger is received.
Counter	This parameter is only available when trigger source = External or Manual. This parameter is used to specify the number of burst trains will be output at every trigger.
Polarity	This parameter is only available when Burst type = Gated and is used to specify the polarity of the gated signal. When polarity = positive, the carrier signal is only output when gated high; when polarity = negative, the carrier signal is only output when gated low
Trigger delay	This parameter is used to set the delay time from the trigger edge to the head of the burst. The minimum value of the trigger delay represents the minimum delay that can be achieved in hardware.

Trigger output	This parameter is only available when the trigger source = internal or manual, and can be set to Up (rising edge align), Down (falling edge align), or Off (disable trigger output).
Edge	This parameter is only available when the trigger source = external and is used to specify the rising edge or falling edge as the trigger edge.
Hold Value	This parameter is used to specify the output signal at the end of the burst. It can be set to Start Value (start of the burst), End Value (end of the burst), and Middle Value (the Offset value).



Application example: 10 kHz sine waveform as the carrier, with a burst output every 10 ms, each burst containing 5 periods

1. Set "Waveform" of the carrier to "Sine" and "Frequency" to 10 kHz in the parameter setting page of the carrier.
2. Enter the Modulation/Sweep/Burst settings and set "Burst" to "On"
3. Set "Type" to "NCycle"
4. Set "Source" to "Internal"
5. Set "Burst Period" to 10 ms
6. Set "Cycles" to 5
7. Set "Trig Out" to "Up", turn on the trigger output. Use the rising edge of the trigger output to trigger the oscilloscope to steadily capture the burst signal
8. Turn on the channel output and observe the results

Follow these steps to generate the desired burst signal. The burst parameters page after the setup is shown below.

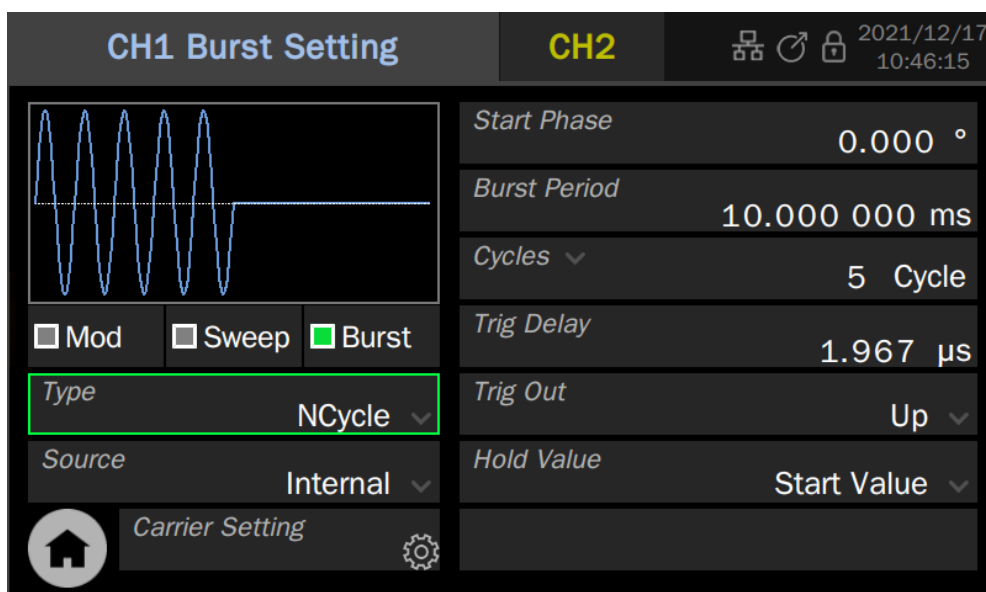

The results of the burst output are as follows: (red trace is the burst signal and blue trace is the trigger signal).

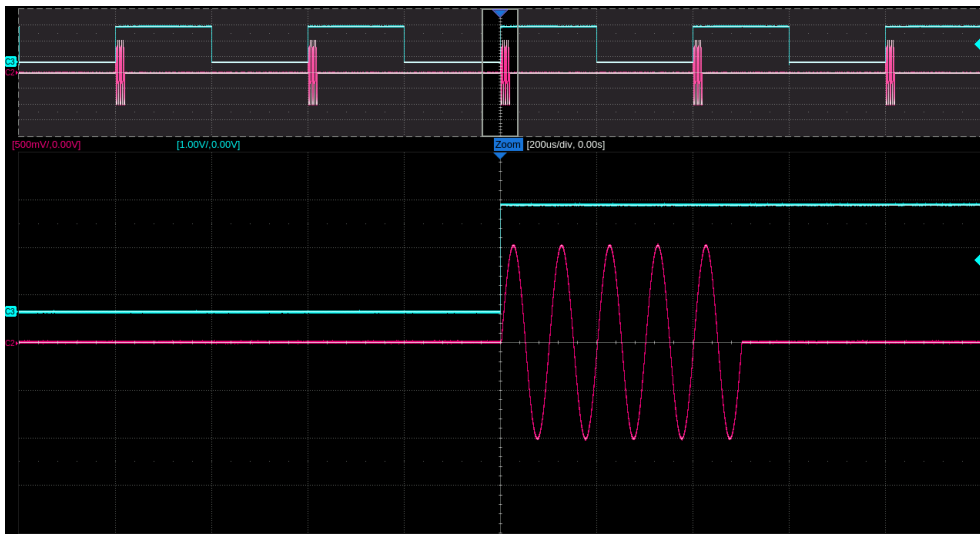

Application example: Manual trigger, 3 burst trains per trigger, 10 ms interval between burst trains and each burst contains 10 pulses, carrier frequency 10 kHz, pulse width 20 us

1. Set "Waveform" of the carrier to "Pulse", "Frequency" to 10 kHz, and "Pulse Width" to 20 us in the parameter setting page of the carrier.
2. Enter the Modulation/Sweep/Burst settings screen and set "Burst" to "On"
3. Set "Type" to "NCycle"
4. Set "Source" to "Manual"
5. Set "Burst Period" to 10 ms
6. Set "Cycles" to 10
7. Set "Counter" to 3
8. Set "Trig Out" to "Up", turn on the trigger output. The rising edge of the trigger output is synchronized with the burst sequence and can be used as a trigger signal to capture the burst
9. Open channel output
10. Click on the trigger button in the bottom right corner of the setup page and use the trigger output signal on the oscilloscope as a trigger for a single capture

Follow these steps to generate the desired burst signal. The burst parameters page after the setup is shown below.

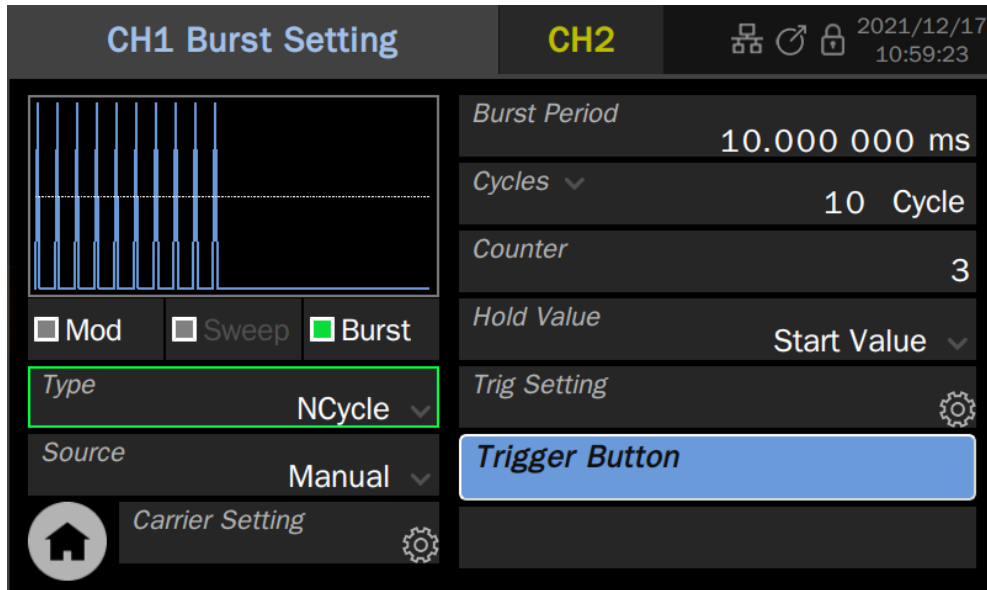

The result of the burst output is shown below (the red trace is the burst signal and the blue trace is the trigger signal). As you can see, in this example, multiple bursts can be obtained with a single trigger, each containing a specified carrier period.

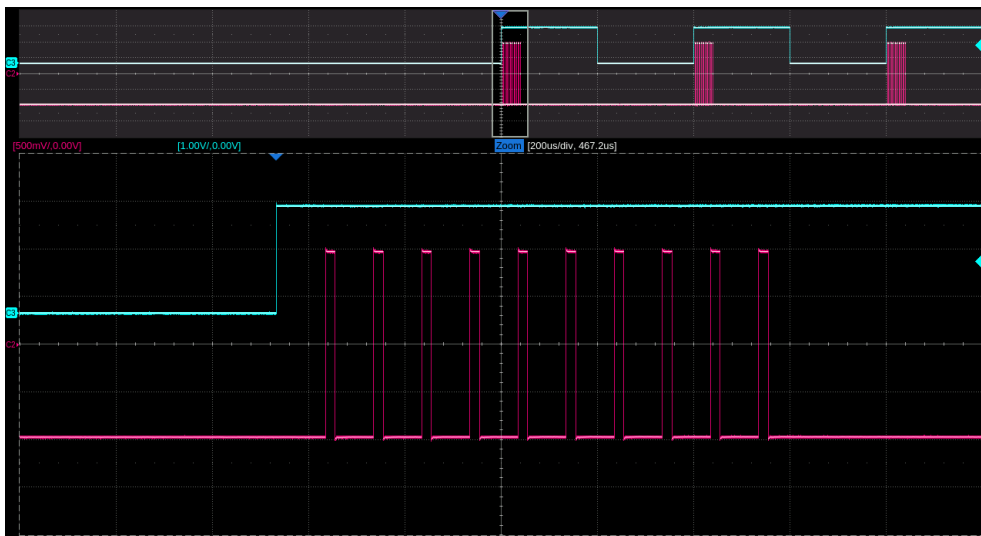

11 Hopping

11.1 Hopping type

Frequency hopping only supports AM modulation with sine or sine carrier.

Click on the Hopping in the toolbar on the home page to access the relevant settings. Similar to sequence, the frequency hopping function is divided into two steps: function opening and frequency hopping output. When the frequency hopping function is opened, the sweep, burst and other functions are automatically closed, and the basic wave is automatically switched to sine (when the current channel carrier is not sine), and the normal output is stopped. After editing the frequency hopping parameters, turn on the frequency hopping output and output the frequency hopping signal.

There are three modes of manual, random hop and random list. Different modes can be switched through the "Type" menu. According to different frequency hopping types, there are three lists to set. The set list can be saved to a file for next call.

See the following table for details:

Table 11-1 Types of hopping

Hopping type	Description
manual	Output the frequency points set in the frequency lists according to the customized order list
random hop	According to the selected PRBS code type, output each frequency point of the frequency lists automatically generated by the set frequency step in the maximum and minimum frequency range
random list	Output the frequency point set in the frequency list according to the selected PRBS code type

Table 11-2 Function description of list

Function	Description
Add	Add one item at the end of the list
Insert	Insert an item after the selected item
Delete	Delete the selected item or delete the last item
Clear	Clear all new items and restore default items
Save/Recall	Save all current list configurations to the hop file or call the configuration of the current list in the hop file



During frequency hopping output, it is not allowed to edit the parameters related to frequency hopping. It can be edited only after the frequency hopping output is stopped;

Frequency hopping cannot be enabled when IQ is enabled.

11.2 Manual

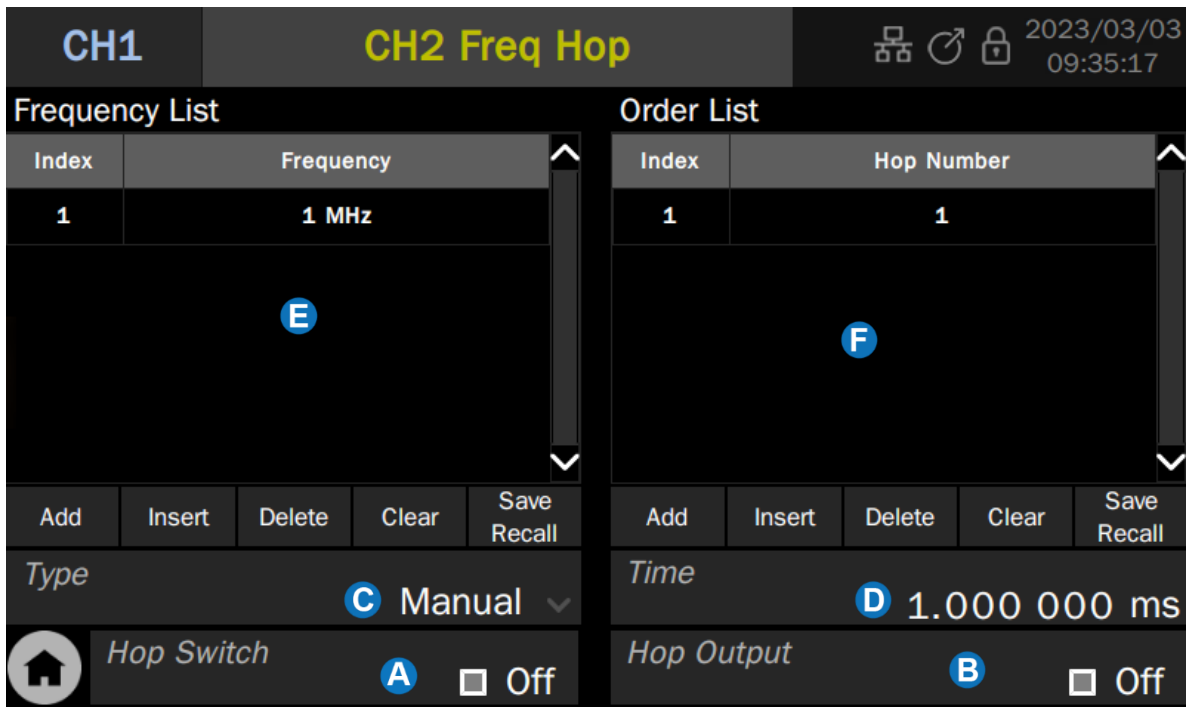

- A** Hop function switch
- C** Hop mode setting
- E** Frequency list setting

- B** Hop output switch
- D** Hop time setting
- F** Order list setting

Manual Parameters

Table 11-3 Manual Parameters Description

Manual	
Frequency list	Set the frequency of each frequency point
Order list	Set the order of frequency point output in the frequency list
Time	Set frequency hopping interval



Application example: In the manual mode, three frequency points of 1MHz, 100KHz and 10MHz are output in order, and the output time of each frequency point is 1s

1. In the hopping setting interface, select the manual in the type of hop setting box
2. The frequency list is set with three items, with frequencies of 100KHz, 10MHz and 1MHz respectively
3. Set three items in the order list, namely 3, 1 and 2
4. Set the time to 1s in the time setting box
5. Turn on the hop function switch

6. Turn on the hop output switch

Follow these steps to generate the desired hop signal. The hop parameters page after the setup is shown below.

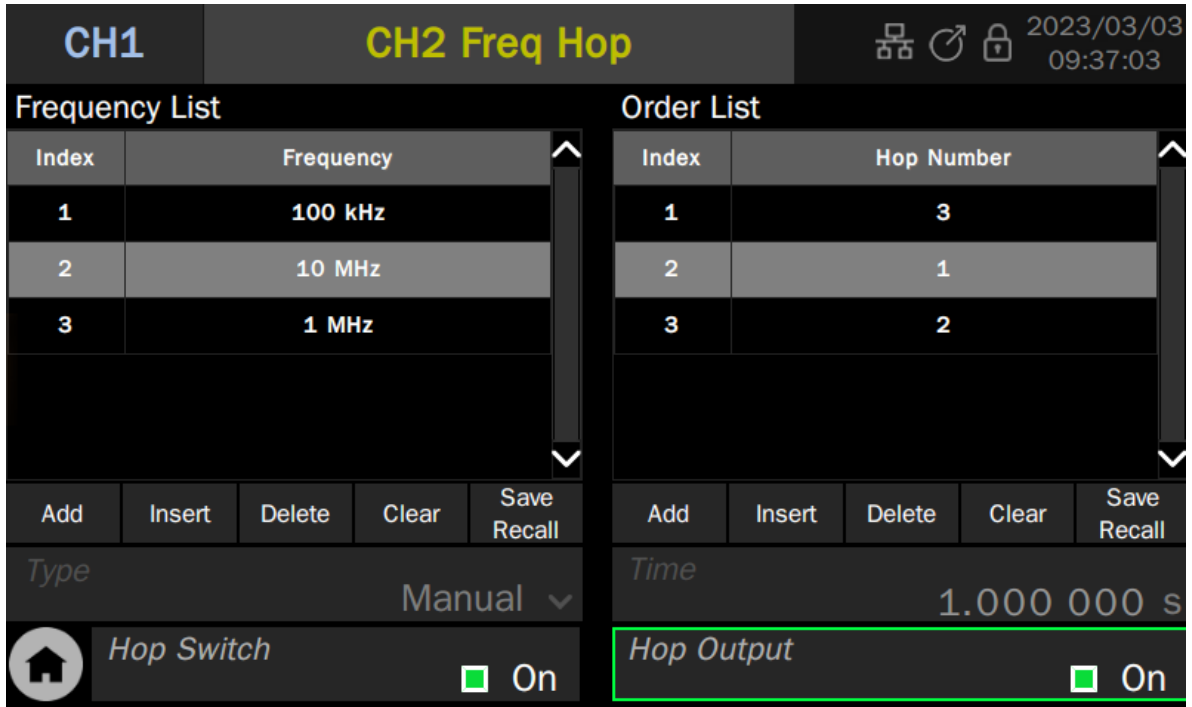

11.3 Random hop

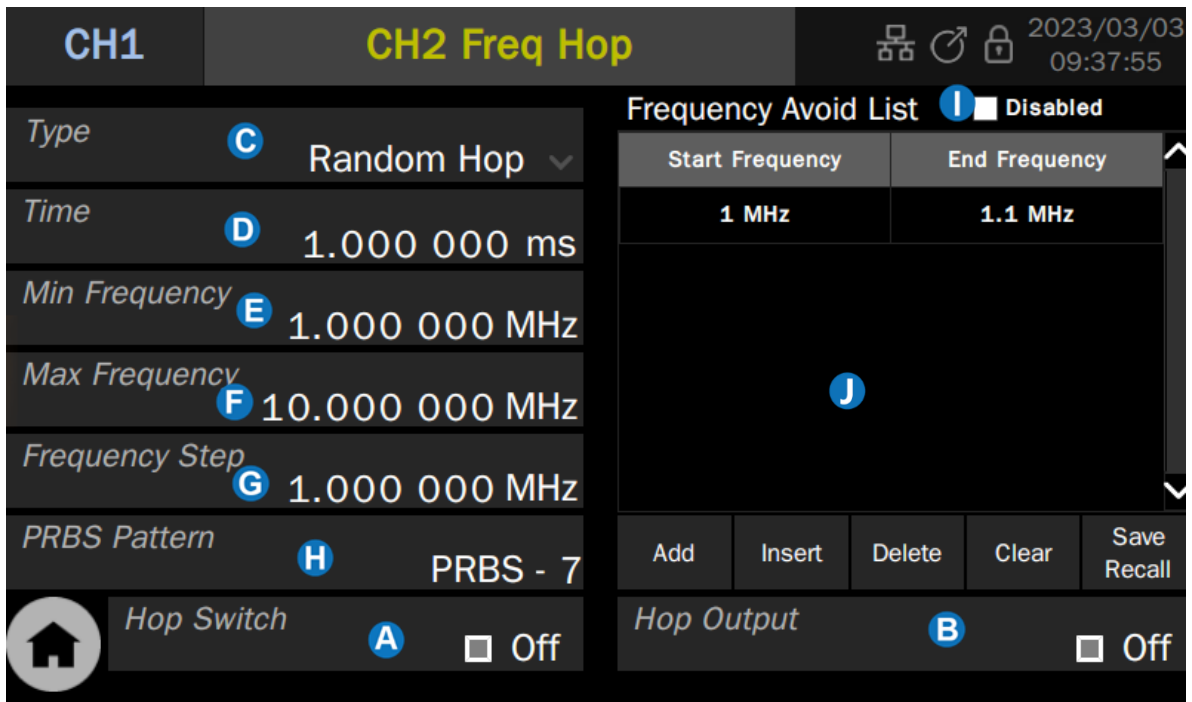

- | | |
|---|---------------------------------------|
| A Hop function switch | B Hop output switch |
| C Hop mode setting | D Hop time setting |
| E Min frequency setting | F Max frequency setting |
| G Frequency step setting | H PRBS setting |
| I Enable of frequency avoid list setting | J Frequency avoid list setting |

Random hop Parameters

Table 11-4 Random hop Parameters Description

Random hop	
Frequency avoid list	Set and enable the frequency filter table to filter out unwanted frequency bands
Time	Set the time for each frequency point
Min frequency	Set the minimum frequency of randomly generated frequency list
Max frequency	Set the maximum frequency of randomly generated frequency list
Frequency step	Set the frequency interval of randomly generated frequency list
PRBS	Set hop output order



Application example: In random hop, output hop in order of PRBS5, within 1MHz~20MHz in 1MHz steps. Each frequency point is output for 50ms, and 6MHz~9MHz frequency points are not expected to be output.

1. In the hopping setting interface, select the random hop in the type of hop setting box
2. Set the time to 50ms in the time setting box
3. Set 1MHz in the min frequency setting box
4. Set 20MHz in the max frequency setting box
5. Set 1MHz in the frequency step setting box
6. Set 5 in the PRBS setting box
7. Set an item in the frequency filter table setting box, where start frequency is set to 6MHz and end frequency is set to 9MHz
8. Turn on the switch of frequency avoid list
9. Turn on the switch of the hop function
10. Turn on the switch of the hop output

Follow these steps to generate the desired hop signal. The hop parameters page after the setup is shown below.

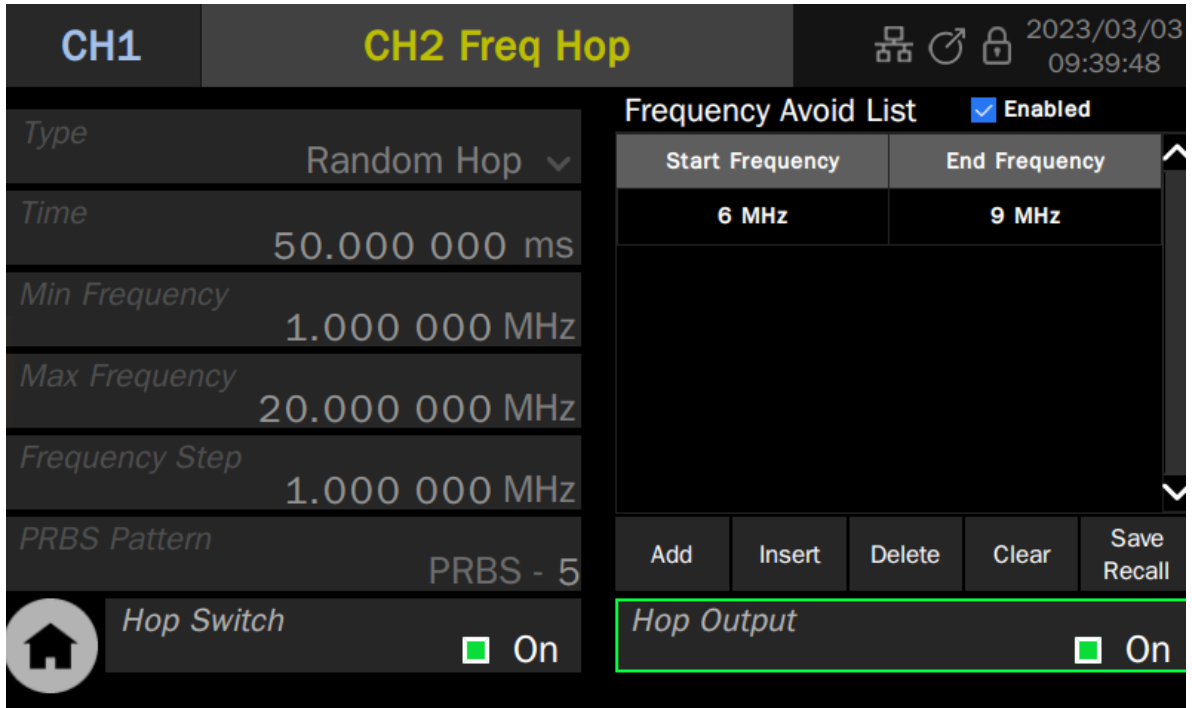

11.4 Random list

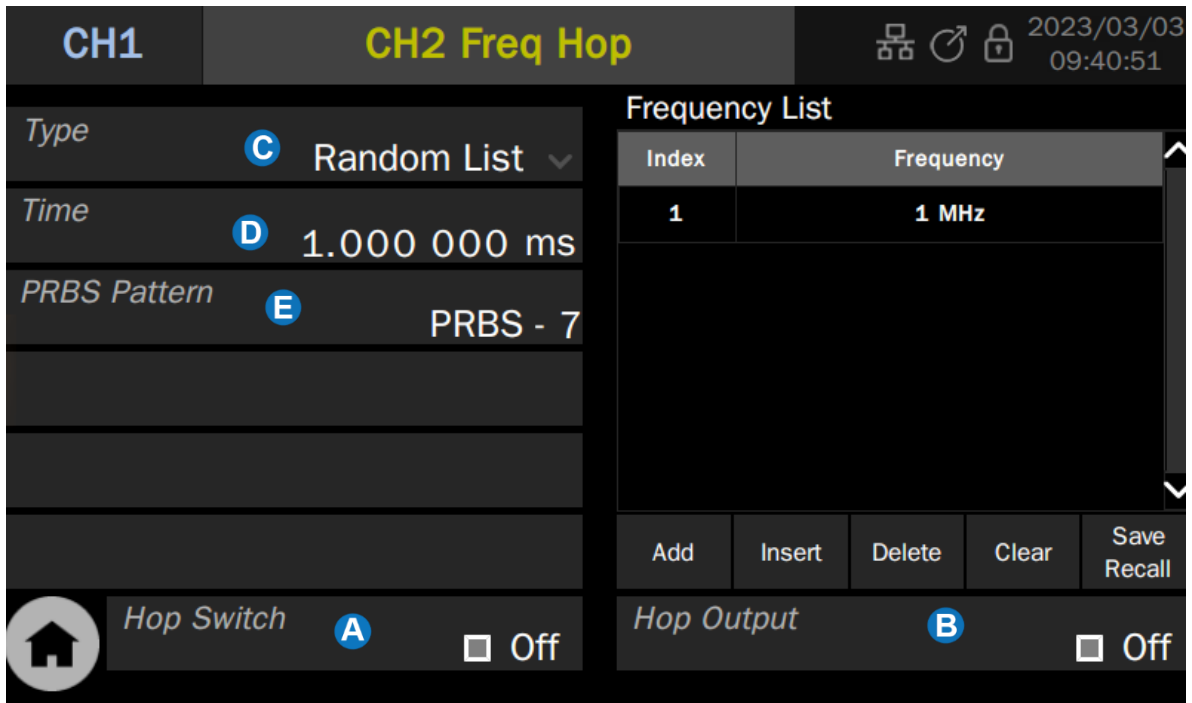

- A** Hop function switch
- B** Hop output switch
- C** Hop mode setting
- D** Hop time setting
- E** PRBS setting
- F** Frequency list setting

Random list Parameters

Table 11-5 Random list Parameters Description

Random list	
Frequency list	Set the frequency of each frequency point
PRBS	Set hop output order
Time	Set frequency hopping interval

12 Dual Channel Setup

12.1 Overview

The SDG7000A features enhanced dual channel functionality. With two phase modes, the unit can be used as two independent signal generators, or the two channels can be output synchronously. The ability to track, copy, and couple between the two channels ensures that parameters from one channel are quickly transferred to the other as required, greatly simplifying operation and meeting the need for fast, simultaneous waveform switching. The ability to combine two waveforms and output them in real-time, with the ability to superimpose true noise, modulated signals, sweep signals, burst signals, EasyPulse waveforms, and TrueArb waveforms, provides users with a new means of accurately generating complex waveforms.

Click on **Dual Channel** in the toolbar on the home page to access the settings related to Dual Channel.

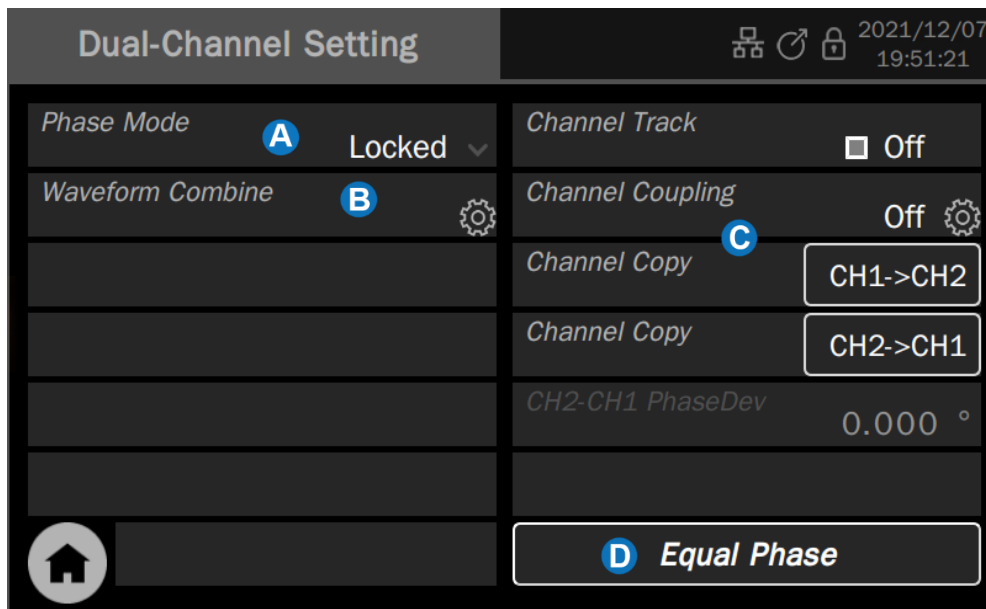

- A** Phase mode parameter setting box
- B** Waveform Combine parameter setting box
- C** Channel tracking/coupling/copy parameter setting area
- D** Equal Phase button, click which to force the phase of both channels to equal

12.2 Phase Mode

The SDG7000A supports two phase modes.



Independent mode: Two channels can be used as two independent signal generators, setting one channel does not affect the output of the other channel



Locked mode: Synchronous output of both channels, initially phase-aligned and ensuring that they are phase-locked when the frequencies are integer multiples of each other, with no drift

In "Independent" mode, the two channels can be used as two independent signal generators, and setting one channel will not affect the output of the other channel.

In "Locked" mode, setting the time parameter of either channel will force the two channels to reset to ensure that they are phase aligned. In addition, the frequency calculation of the channels is specially handled in "Locked" mode to ensure that the two channels are phase-locked when the frequencies are integer multiples of each other and do not drift.

DDS (Direct Digital Synthesis) technology has the advantage of high-frequency resolution and fast frequency switching compared to PLL (Phase Locked Loop) technology. However, DDS is an open-loop system and does not allow for true 'locking' between input and output in the same way as a phase-locked loop, i.e. the input and output of a DDS structure may not be phase-locked and the output may drift in phase when viewed over long time durations.

As an example, set CH1 to output a 1 MHz frequency clock and CH2 to output a 10 MHz frequency clock, according to the relationship between the DDS frequency control word (FTW) and the output frequency f_{out} .

$$\frac{f_{out}}{F_{DDS}} = \frac{FTW}{2^N}$$

With the DDS operating frequency $F_{DDS} = 2.5$ GHz and the bit width of the frequency control word $N = 52$, the actual output frequencies and frequency errors for both channels can be calculated as shown in the table below. The error is introduced by the rounding of the frequency control word. As the FTW is passed to the DDS circuit as a fixed-point integer, an error is inevitably introduced between the theoretical and actual value of the FTW.

Table 12-1 Frequency errors in independent channel mode

Set frequency	1 MHz	10 MHz
Calculated value of frequency control word	1801439850948.198	18014398509481.98
Frequency control word rounding	1801439850948	18014398509482
Actual output frequency	0.999999999999998899 MHz	10.000000000000009 MHz
Frequency error	-0.1101288944482803 μ Hz	0.009313225746154785 μ Hz

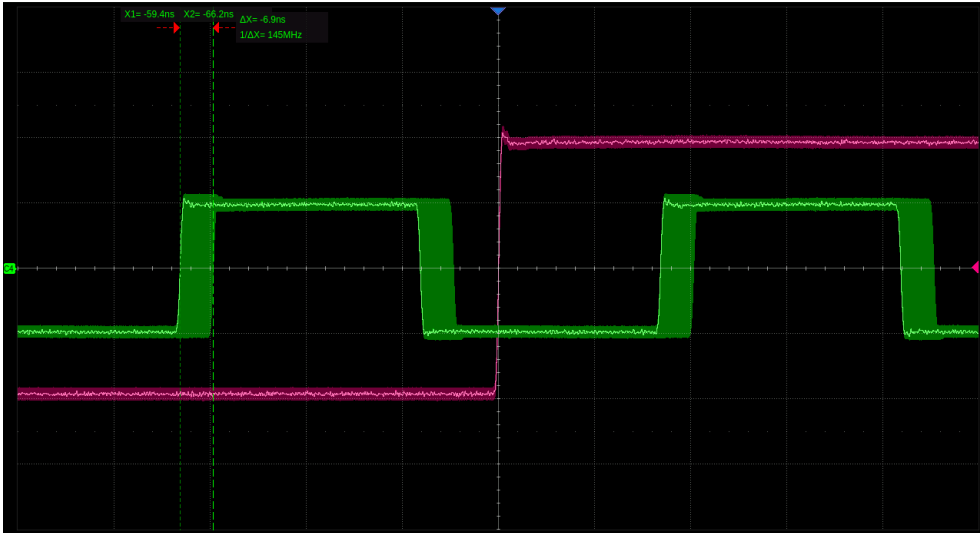

As we can see from the table above, the frequency errors introduced on both channels are small, but not proportional, which results in the two frequencies that were integer multiples no longer being integer multiples, with the result that they are not phase-locked. The following is the phase drift (approximately 6.9 ns) observed in this example after 17.3 hours for both channels in "Independent" mode.

In "Lock" mode, the unit forces the higher frequency FTW to be an integer multiple of the lower frequency FTW for frequencies that are an integer multiple of each other, which may increase the output error at the higher frequency but ensures phase lock between the two. In this example, the outputs of the two channels in "Locked" mode are observed over a long period. As we can see, the phases are always aligned.

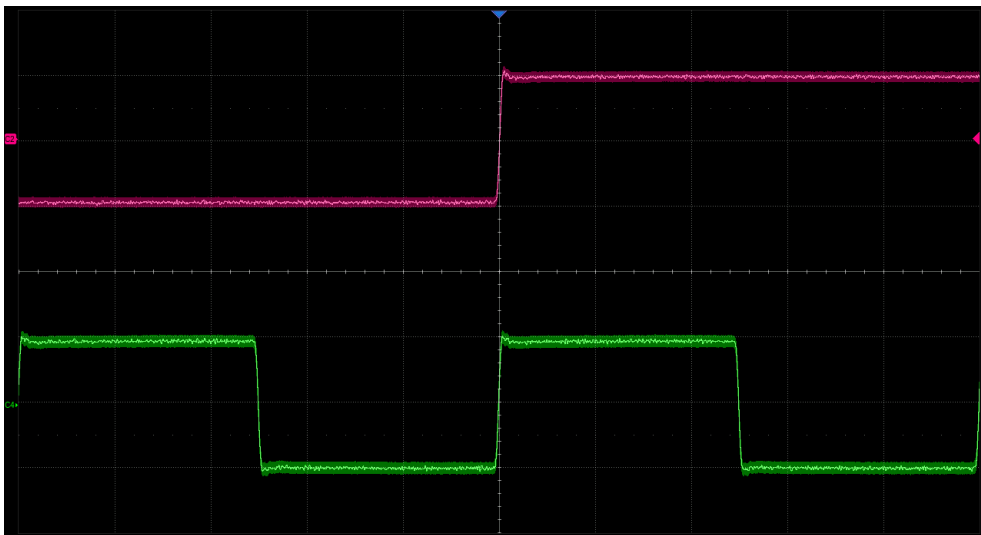

12.3 Waveform Combine

The waveform combining function superimposes basic waveforms, random noise, modulation signals, sweep signals, burst signals, EasyPulse waveforms, and TrueArb waveforms

On the "Dual-Channel Settings" page, click on the icon **D** in the "Waveform Combine" parameter setting box to enter the waveform combine setting.

Output port 1 can be selected to output the waveform of CH1 or CH1+CH2; output port 2 can be selected to output the waveform of CH2 or CH1+CH2.

You can also set the output of individual channels or a combined waveform by clicking on the corresponding selector directly from the block diagram on the home page.

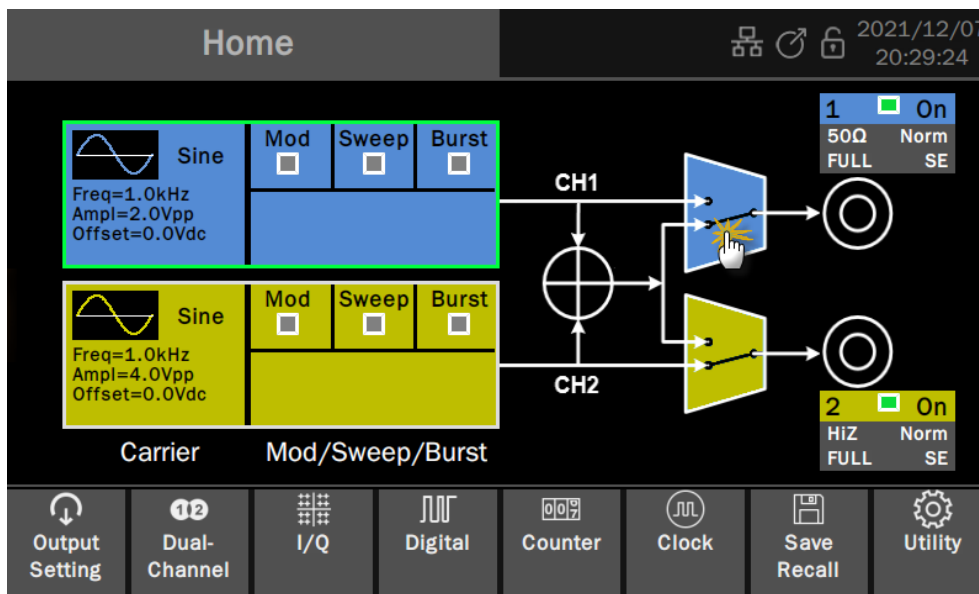

Application example: Simulation of a 1 MHz sine wave contaminated by Gaussian noise with an output amplitude of 1 Vrms with a signal to noise ratio of 20 dB

1. Set "Waveform" of the carrier to "Sine", "Frequency" to 1 MHz and "Amplitude" to 1 Vrms in the parameter setting page of CH1.
2. According to Signal to noise ratio 20 dB, converted to a signal to noise amplitude ratio (s/σ) of 10:1. from signal amplitude $s = 1$ Vrms gives noise amplitude $\sigma = 100$ mVrms
3. Set "Waveform" to "Noise" and "Standard deviation" to 100 mV on the CH2 carrier parameter page.
4. Set "Output1" to "CH1+CH2" in the setup of "Waveform Combine".
5. Turn on the CH1 channel output and observe the results.

By following these steps, the desired signal is output. The output is as follows: (the red trace is the signal without noise, while the green trace is the signal with noise).

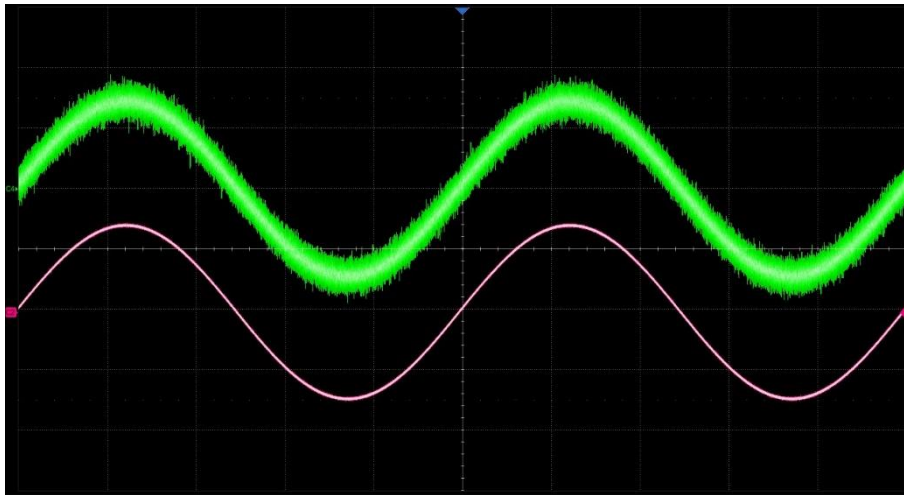

12.4 Channel Tracking/Coupling/Copy

Channel track/coupling/copy can be set up under the 'Dual-Channel Setting' page. The ability to track, copy, and couple between two channels ensures that parameters from one channel are quickly transferred to the other as required, greatly simplifying operation and meeting the need for fast, simultaneous waveform switching.

Table 12-2 Description of channel tracking/coupling/copy

Type of operation	Description
Track	<p>The parameters of the two channels are fully synchronized and the parameters set for one channel are automatically passed to the other channel, where the two channels are duplicates of each other.</p> <p>In tracking mode, the device will force the phase mode to "Locked" and only allow the setting of CH1.</p>
Coupling	<p>The parameters of the two channels are coupled in a certain relationship with CH1 as reference so that the parameters of one channel are automatically converted and passed to the other channel according to the coupling relationship.</p> <p>The coupling parameters that can be set are frequency, amplitude, and phase, and the coupling relationship can be proportional or deviated.</p>
Copy	<p>Manually copy parameters from one channel to another. Changing the parameters of one channel after that will not cause the parameters of another channel to change.</p>



Application example: Use the channel copy function and the waveform combine function to generate a two-tone signal at frequencies 10 MHz and 10.1 MHz. the output amplitude is 0 dBm for both frequencies

1. Set "Waveform" of the carrier to "Sine", "Frequency" to 10 MHz, "Load" to 50 Ω , and "Amplitude" to 0 dBm in the parameter setting page of CH1.
2. Execute the channel copy function "CH1 -> CH2" on the "Dual-Channel Setting" page
3. Change "Frequency" to 10.1 MHz under the settings of the CH1 carrier parameters page
4. Set "Output1" to "CH1+CH2" in the setup of the "Waveform Combine".
5. Turn on the CH1 channel output and observe the results

By following these steps, the desired signal is output. The results of the spectrum of the output two-tone signal are asbelow:

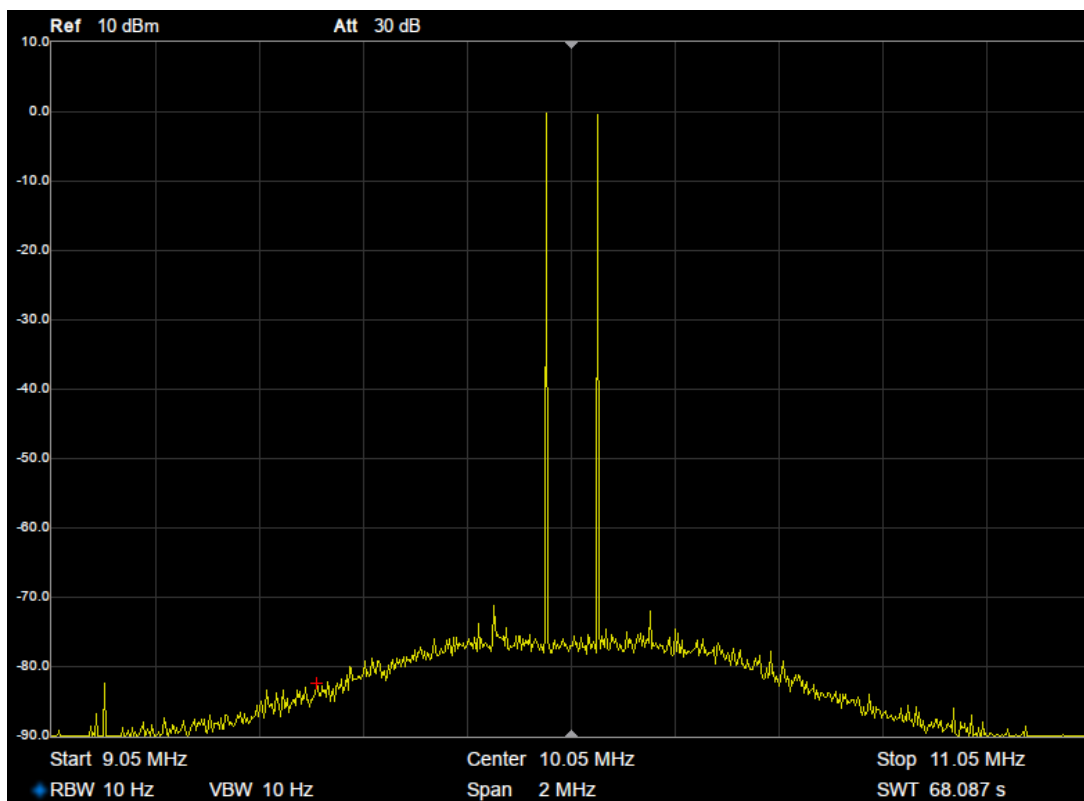

13 Output Settings

13.1 Overview

Each channel contains several signal processing/settings before/after the waveform is output from the DAC, including polarity control, superimposing noise, digital filtering, amplitude limiting, protection, and single-ended/differential control.

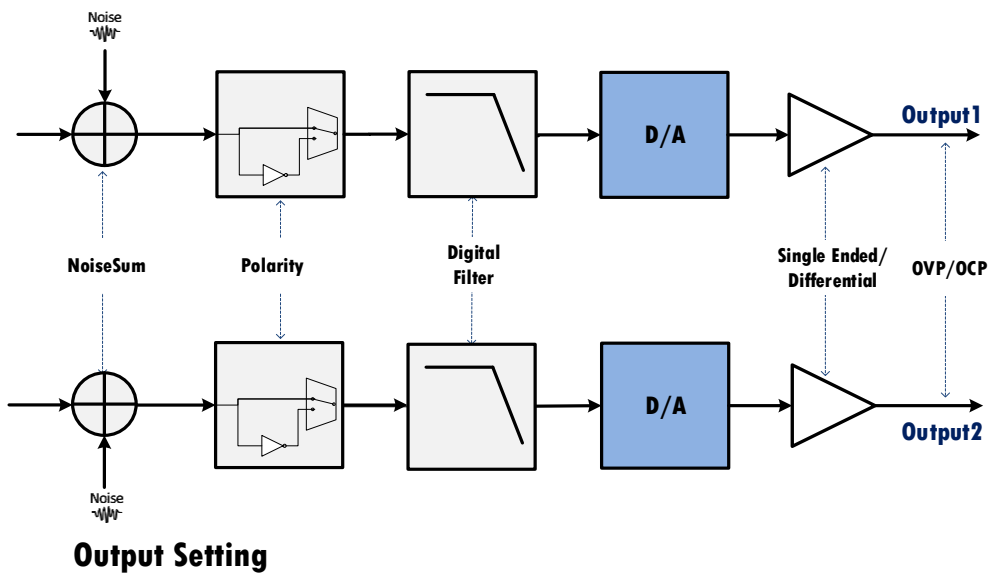
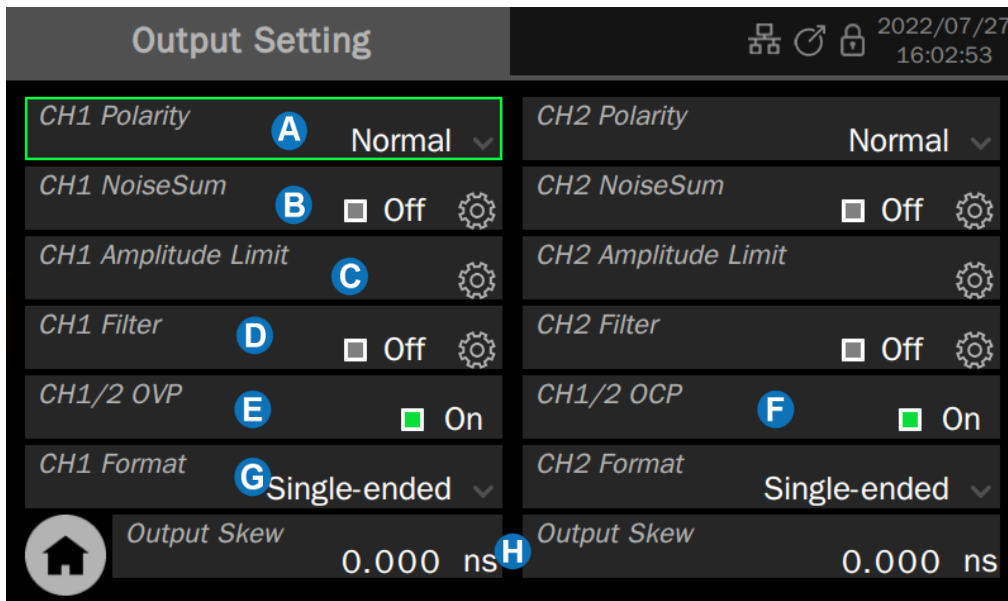

Figure 13-1 Block diagram of output setting

The relevant settings page can be accessed by clicking on Output Settings in the toolbar on the home page.



- A** Polarity setting
- B** Noise superimposing setting
- C** Amplitude limit setting
- D** Filter settings
- E** Overvoltage protection setting
- F** Overcurrent protection settings
- G** Single-ended/differential output mode setting
- H** Output Skew setting

13.2 Polarity

Positive or negative polarity output can be set. With negative polarity output, the device inverts the data and then outputs it, resulting in a signal that is inverted relative to 0V offset of the positive polarity output.

As shown in the following figure:

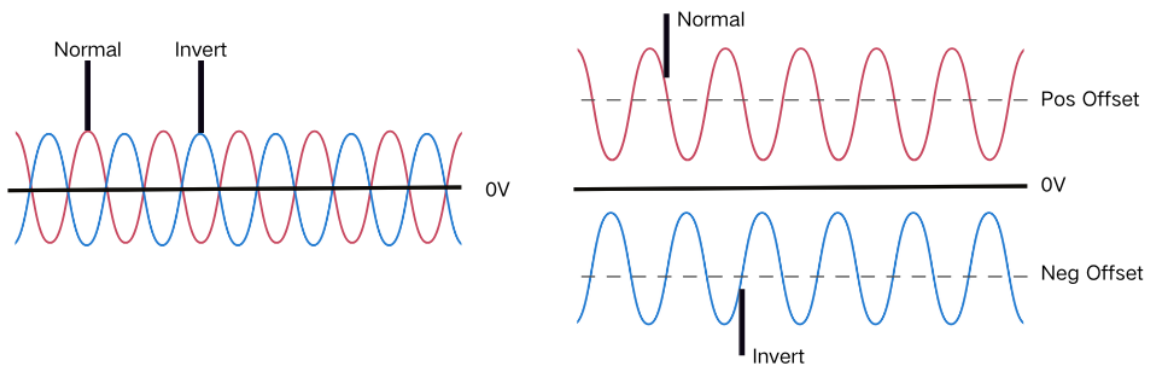

Note:

The Sync signal related to the waveform is not inverted when the waveform is inverted.

13.3 NoiseSum

You can choose to superimpose random noise on the signal and output it to simulate a realistic scenario where the signal is contaminated by noise. Click on the settings icon in the "NoiseSum" parameter setting box  to enter the Noise superimposing settings page, where you can enable the noise superimposing and the signal-to-noise ratio. The signal-to-noise ratio is measured in ratios (dimensionless) or dB.



Application example: Simulation of a 1 MHz sine wave contaminated by Gaussian noise with an output amplitude of 1 V_{rms} with a signal to noise ratio of 20 dB

Note that the requirements of this example are the same as those of the application example in the section "Waveform Combine". The same effect can be achieved by using a NoiseSum function in this section.

1. Set "Waveform" of the carrier to "Sine", "Frequency" to 1 MHz, and "Amplitude" to 1 V_{rms} in the parameter setting page of CH1.
2. Set the "Signal to Noise Ratio" to 20 dB in NoiseSum setting and turn on the NoiseSum function
3. Turn on CH1 channel output

The above steps are followed to generate the desired signal. The output is as followed (the red trace is the signal without noise, while the green trace is the signal with noise) and is consistent with the results of the previous example.

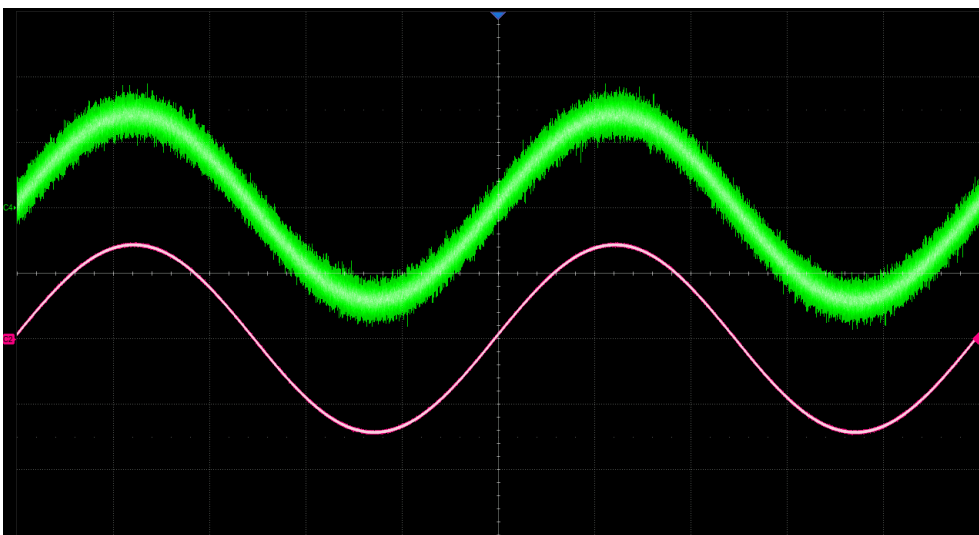

13.4 Amplitude Limit

In some applications, the user needs to limit the amplitude of the channel output to ensure that amplitude sensitive signal receiving device is not damaged. Click on the setting icon  in the "Amplitude Limit" parameter box to access the Amplitude Limit.

The default maximum amplitude is the maximum amplitude that the device can provide, see the datasheet for details.

13.5 Digital Filtering

A 32-tap FIR digital filter is integrated into each channel to support low-pass filtering, with a settable cut-off frequency. This allows the user to limit the bandwidth of the output signal.



Application example: generate a pulse signal with 1 ns edges and set the output filter to 100 MHz, then compare the change in the edges when the output filter is turned on and off

1. In the parameter setting page of the carrier, set "Waveform" to "Pulse", "Frequency" to 1 MHz, "Load" 50 Ω , "Amplitude" to 1 Vpp, "Duty Cycle" to 50%, and "Rising Edge" to 1 ns.
2. Under the "Output1 filter" settings page, set "Cut-off frequency" to 100 MHz.
3. Observe the results without opening the Output1 filter; open the Output1 filter and observe the results again.

The output results are compared below. The measured rising edge without the output filter is around 0.94 ns, which roughly complies with the setting, and the measured rising edge with the output filter on is around 3.6 ns, which roughly complies with the 100 MHz bandwidth.

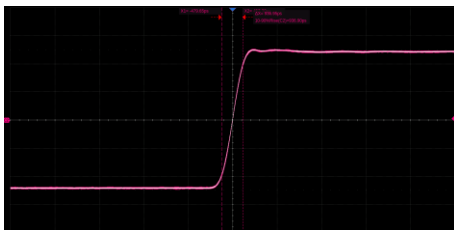

When the output filter is switched off

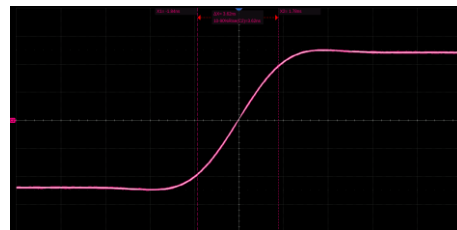

When the output filter is switched on

13.6 Output Protection

The output protection consists of over-voltage protection (OVP) and over-current protection (OCP). OVP and OCP switches are shared by both outputs. Separate control of OVP or OCP for both channels is not supported.

13.7 Single-ended/Differential Settings

The unit offers two output modes, single-ended and differential. They can be set directly in the "Output Settings" page.

The output terminals on the front panel are "+" on the right and "-" on the left when the output is differential, and "+" on the left when the output is single-ended.

The analog parameters will differ between the single-ended and differential output modes, as detailed in the datasheet.

After the output is set to "Differential", a parameter setting box for "Common Mode" will appear on the carrier settings page, providing an entry for setting the common mode of the differential signal, as shown below:

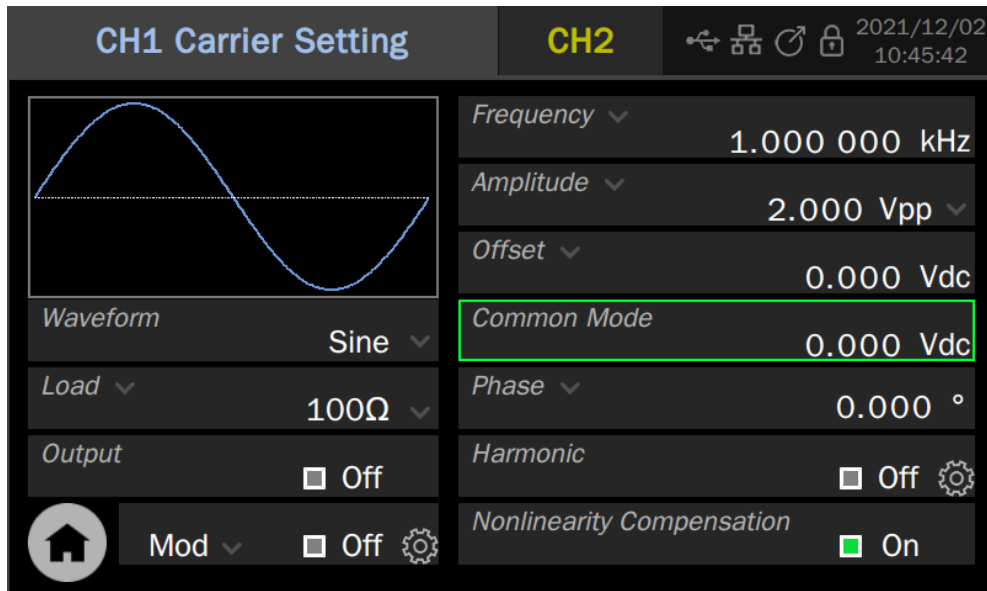

Note the distinction between the concepts of "Common Mode" and "Offset". Both are DC levels, but "Common Mode" refers to the common-mode component of the differential pair, while "Offset" is the differential mode component.







With "differential" output, the "amplitude" of the signal refers to the peak-to-peak value of the differential mode signal, i.e.:

$$V_{pp} = (V_+ - V_-)_{pk-pk}$$

It is related to the peak-to-peak value of the signal on the "+" or "-" alone by a factor of 2.

13.8 Output Skew

The device provides the function of adjusting the skew of two channels, with a single channel adjustment range of $\pm 0.2\text{ns}$, as shown in the following figure:

Output Setting		2023/04/14 09:22:18	
CH1 Polarity	Normal ▾	CH2 Polarity	Normal ▾
CH1 NoiseSum	<input type="checkbox"/> Off 	CH2 NoiseSum	<input type="checkbox"/> Off 
CH1 Amplitude Limit		CH2 Amplitude Limit	
CH1 Filter	<input type="checkbox"/> Off 	CH2 Filter	<input type="checkbox"/> Off 
CH1/2 OVP	<input checked="" type="checkbox"/> On	CH1/2 OCP	<input checked="" type="checkbox"/> On
CH1 Format	Single-ended ▾	CH2 Format	Single-ended ▾
 Output Skew	0.000 ns	Output Skew	0.000 ns

14 Digital Channels

14.1 Overview

The SDG7000A provides 16 digital signal outputs. The digital output function is available with the optional digital output kit. There are two digital levels to choose from: LVTTTL and LVDS. The LVTTTL kit output converts the LVDS signal output by the device into LVTTTL signals and outputs it. Since the level conversion requires a special chip, the kit needs an external USB power supply. The kit providing LVDS output directly leads out the LVDS signal of the device without an external power supply.



LVTTTL output Kit

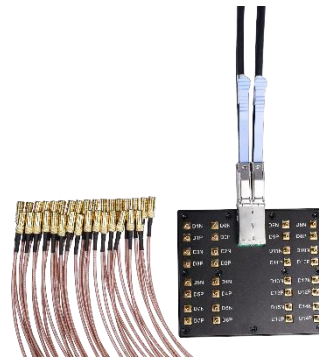

LVDS output Kit



Since the speed of the LVTTTL output kit is limited by the LVTTTL level itself, it supports a lower maximum digital signal rate than LVDS models. Refer to the datasheet for details

14.2 Digital Channel Settings

Click on Digital Channels in the toolbar on the home page to access the digital channel settings.

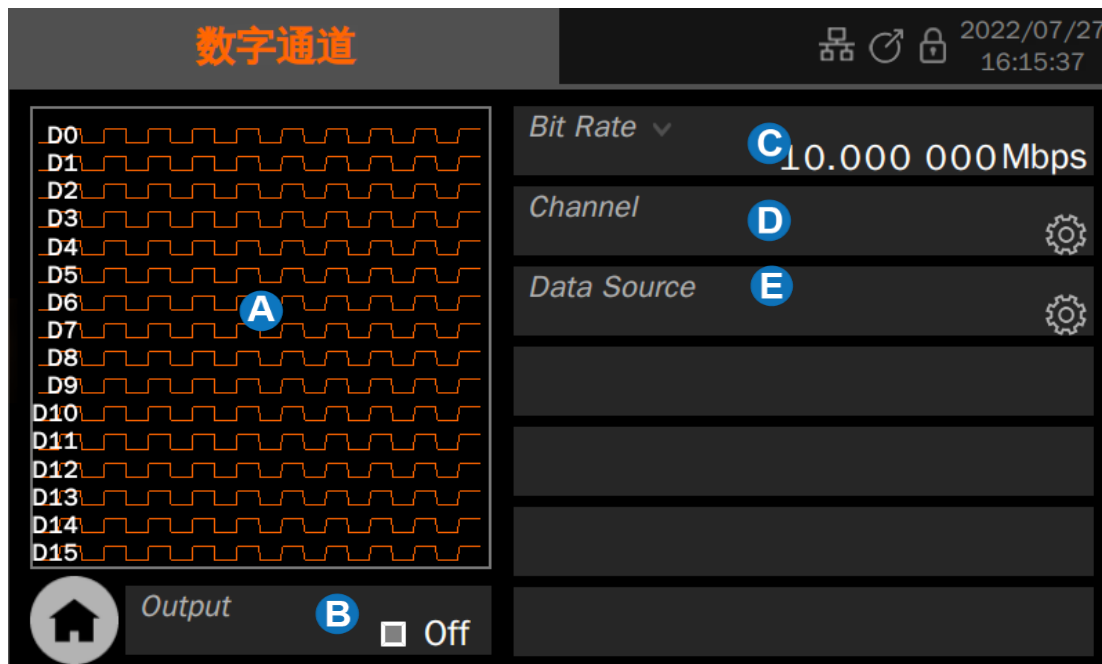

- A** Waveform preview image
- B** Output control: Click the switch on the right side of the setting box to switch on/ off the output of the specified channel in **D**
- C** Bit rate parameter setting box
- D** Channel setting box
- E** Data source selection

Channel Settings

Select a specific channel output.

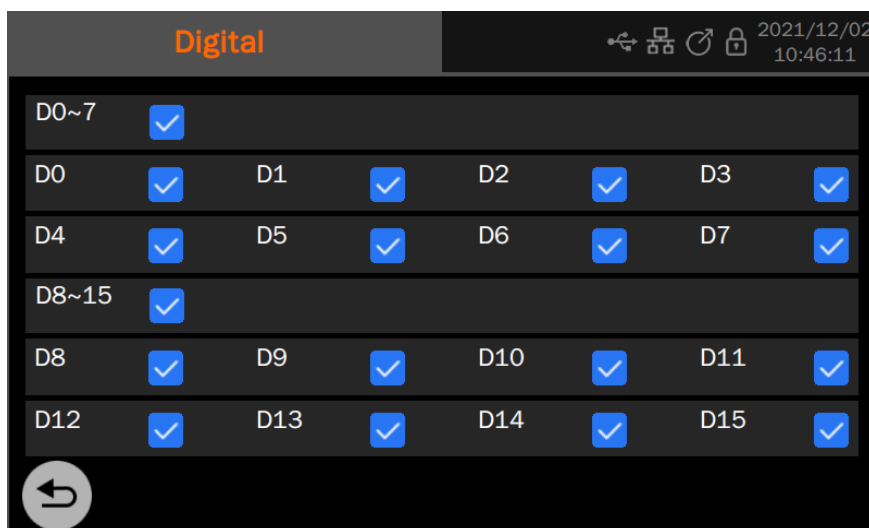

Click on the checkboxes to the right of D0~7 to turn on/off all 8 channels from D0~D7, or select some of the channels from D0~D7 individually at the bottom; the same applies to D8~15.

Data Sources

The data sources include both built-in and stored waveforms. The data sources are recalled in the same way as Arb. For details, please refer to the "Data Source" section of the "Arbitrary Waveform Setting".

Sequence Settings

This is the same as for Arb. See the section "Sequence Setting" for details.

15 Counter

15.1 Overview

The counter is used to measure the frequency or period of the current signal, or to count the currently specified trigger event. Click on the Counter in the toolbar on the home page to access the relevant settings. The counter works in two modes: Frequency counter mode and Totalizer mode.

15.2 Frequency Counter Mode

The parameter setting page for the frequency counter mode is as follows:

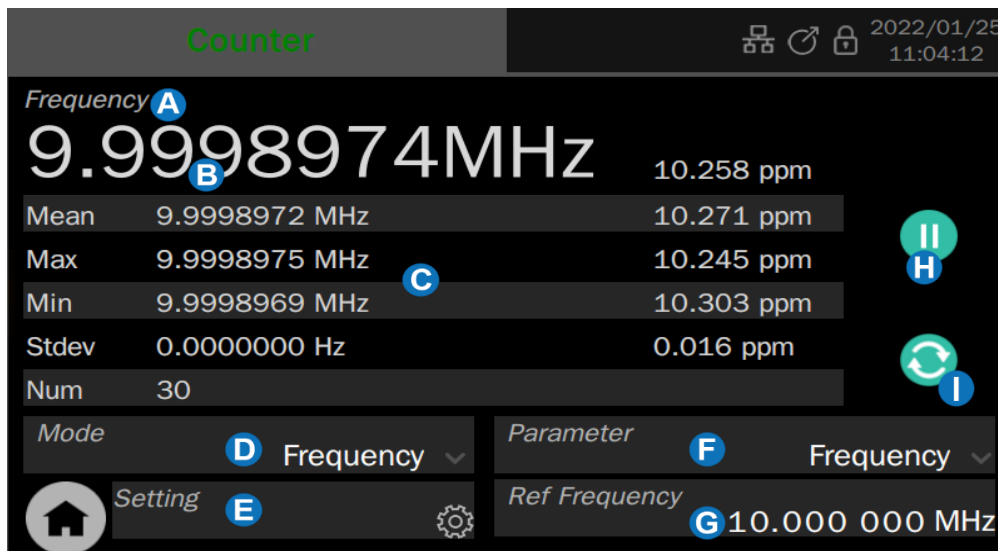

- A** When the mode in **D** is "Frequency ", the measurement parameters relating to the frequency counter are displayed here (frequency, period or duty cycle). When the mode is "Totalizer", the Totalizer is displayed
- B** Measured value of the current parameter. The value shown in small print on the right is the deviation of the measured value from the reference value entered at the reference point, **G** expressed in parts per million (ppm)
- C** Parameter statistics display area
- D** Working mode parameter setting box
- E** Frequency counter setting
- F** The parameter setting box is displayed. Parameters that can be displayed include frequency, period, and duty cycle
- G** Reference frequency parameter setting box, where you enter the desired input frequency and the frequency counter automatically calculates the deviation of the measured value from the reference frequency
- H** Pause measurement
- I** Clear statistics

Statistics

The frequency counter keeps a tally of the historical measurement data and displays the results on the screen.

Table 15-1 Description of frequency counter statistics

Statistical values	Description
Mean	Average - Arithmetic average of all historical measurements
Max	Maximum value - Maximum value of all measured values in history
Min	Minimum value - Minimum value of all measured values in history
Stdev	Standard deviation – The standard deviation of all historical measurements, used to determine the distribution of measured parameters
Count	Number of statistics - Number of measurements obtained

Click on the icon to the right of the statistics area to restart the statistics.

Settings

Click on the settings icon in the "Settings" parameter setting box to enter the frequency counter settings. The parameters that can be set and their descriptions are shown in the following table:

Table 15-2 Description of frequency counter parameters

Parameters	Description
Coupling	AC/DC coupling mode is selectable. DC coupling allows all frequency components to pass, while AC coupling blocks the DC component and only allows the AC component to pass
High-frequency rejection	Rejects high-frequency components of the signal. Suitable for testing low-frequency signals for higher signal-to-noise ratio
Trigger level	The input signal is compared with the trigger level to produce a counting pulse. The trigger level is generally recommended to be set to Positioned at 50% of the signal
Close on exit	When set to On, the counter function is automatically switched off when exiting the counter's setup page, and the EXT MOD/CNT port is switched to the EXT MOD function. When set to Off, the counter function remains in the background when exiting the counter's setup page and the EXT MOD/CNT port remains CNT enabled.



In most cases, it is recommended to use a configuration with coupling = AC and trigger level = 0V. Only at frequencies < 1 Hz is it recommended to use DC coupling and to set the appropriate trigger level according to the signal level.

15.3 Totalizer Mode

The parameter setting page for the Totalizer mode is as follows:

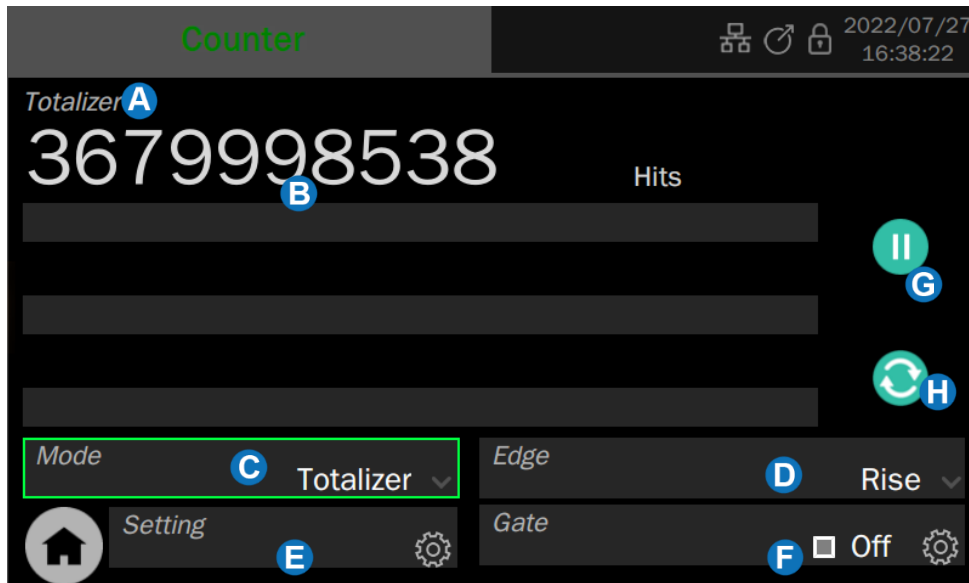

- A** Current operating mode
- B** Current count value
- C** Working mode parameter setting box. The working mode is marked by **A**
- D** Parameter setting box for Totalizer trigger edge
- E** Totalizer settings
- F** Gate setting box
- G** Pause measurement
- H** Clear and reset counting

When the Totalizer mode is selected for counting, the edge of the counting signal has to be set and a gating setting can also be made. The Totalizer will only count if the gating signal meets the conditions. Touch Gate to bring up the Gate Settings dialog.

When the Gate Mode is Level, set the polarity of the Gate source (positive or negative). When the Gate Mode is After Edge, set the slope of the threshold source (rising or falling edge).

16 Save/Recall

16.1 Overview

The SDG7000A can save and recall setups, waveform, firmware update files, etc. Save and recall locations include internal memory (Local), external USB storage devices (e.g. USB stick), or network storage.

16.2 Save Type

The SDG7000A supports save types: Setup (*.xml), Waveform Data (*.awg). Here are brief descriptions of save types:

Setup

The setup is saved with the *.xml file extension.

Setup contains the parameters set by the instrument's functional modules and the auxiliary function parameters under the system settings menu and system parameters, etc.

AWG Data

Saves the waveform data in AWG (*.awg) format. Only sequence waveforms can be saved.

On the Sequence page, you can select to save the current waveform sequence to storage.

16.3 Recall Type

The SDG7000A supports recall types: Setup (*.xml), Waveform Data (binary/csv/dat/awg/arb), Calibration Data (*.cal), Firmware update files (*.ads).

Here are brief descriptions of save types:

Setup

You can call the saved settings file to restore various settings, or set them as the default settings for power on.

AWG Data

On the Sequence page, select recalling *.awg file to load the saved waveform.

Binary Data

The Binary arbitrary wave data files can be recalled directly in AWG data source settings without format conversion.

CSV Data

The arbitrary waveform data (*.csv) can be recalled from external memory and simultaneously converted to *.bin format for storage in the internal memory.

DAT Data

The arbitrary waveform data (*.dat) can be recalled from external memory and simultaneously converted to *.bin format for storage in the internal memory.

Arb Data

I/Q data files.

Calibration Data

Calibration recovery file which can be used to recover the calibration data.

ADS

Firmware upgrade file, recallable from external memory, such as U-Disk or network storage.

The following table shows the relationship between the file types and save/recall operations.

Table 16-1 Save and recall file type

Type	Save to External	Recall
*.xml	√	√
*.awg	√	√
*.bin	×	√
*.csv	×	√
*.dat	×	√
*.arb	×	√
*.ads	×	√
*.cal	×	√





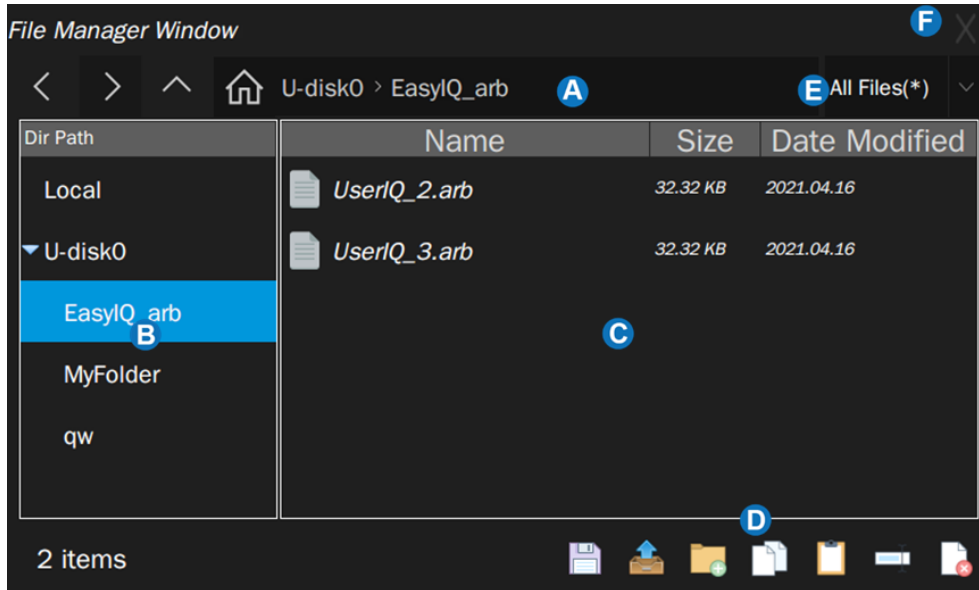





16.4 File Manager

The SDG7000A file manager has a similar style and operation with the Windows® operating systems.



- A** The address bar, which shows the path where the current list of files is located. This includes some shortcuts to the paths, see Table 16-2 for details.
- B** Navigation panel
- C** File list
- D** The toolbar, which provides a variety of specific operations on the documents, is detailed in Table 16-2
- E** File type
- F** Close, click here to exit File Manager

Table 16-2 Descriptions of file manager Icon

Operation icons	Description	Operation icons	Description
	Back		New directory
	Forward		Copy
	Up one level		Paste
	Root directory		Rename
	Save		Delete
	Recall		

16.5 Save and Recall Instance

Save the setup to the path “U-disk0\test”.

1. Insert the U disk
2. Click the Save/Recall icon on the HOME page to open file manager
3. Select the “U-disk0\test” directory in the file manager
4. Click the Save icon  at the bottom right of the page, and a soft keyboard will pop up.

You can change the file name and press enter to save.

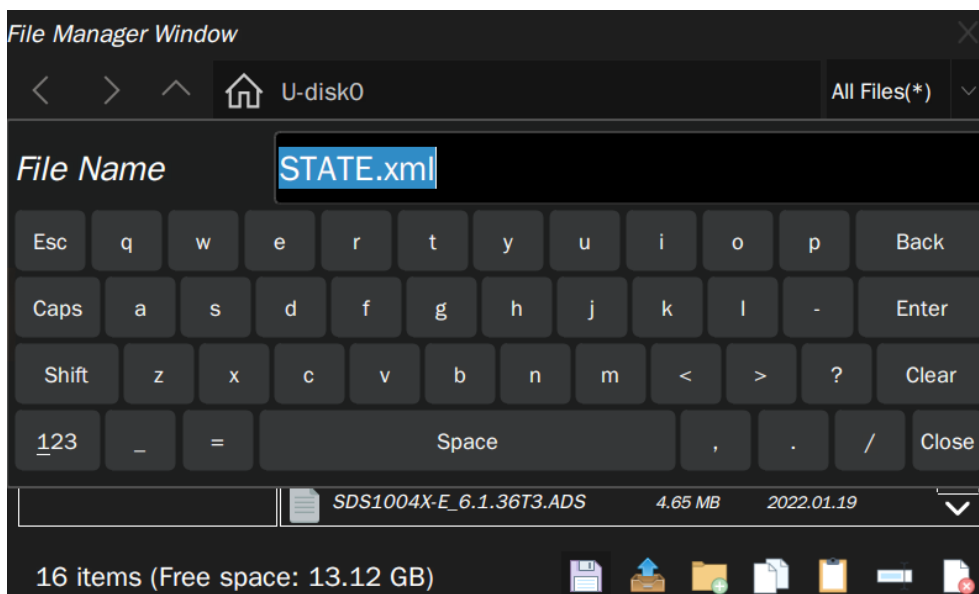

Once saved, the new XML file is visible in the file manager:

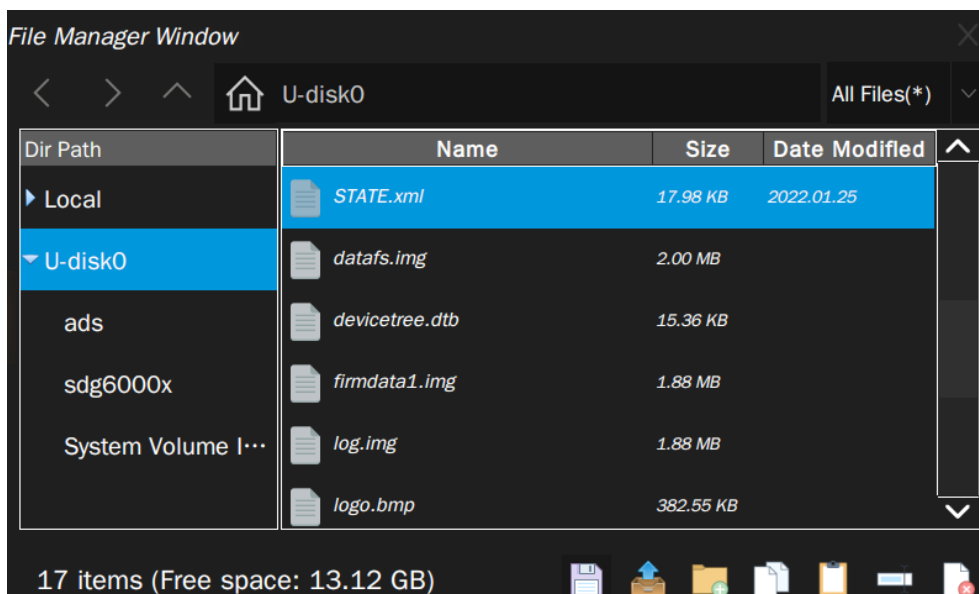

Recall the setup file "STATE.xml" stored in path "U-disk0\test"

1. Insert the U disk with the file "STATE.xml" stored folder "U-disk0\test"
2. Click the Save/Recall icon on the HOME page to open file manager
3. Browse to "U-disk0\test" directory and select the "STATE.xml" file
4. Touch the Recall icon  and wait for the device to finish recalling setup.

17 System Setup

System setup supports auxiliary functions of the device such as checking the system status, setting language and beeper, as well as more advanced settings such as self-calibration, upgrading firmware, and I/O.

Click on Utility in the toolbar on the home page to access the relevant settings page:

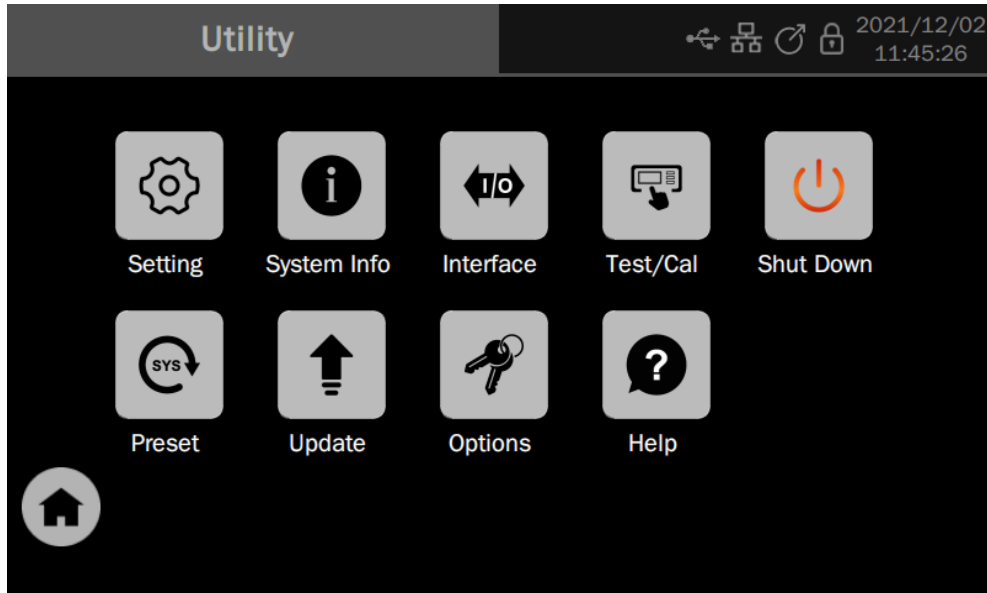

17.1 General Settings

17.1.1 Language

The SDG7000A supports Simplified Chinese and English.

Utility > **Setting** > **Language** , and select the language from the pop-up list.

17.1.2 Sound

Option to enable audible feedback from the beeper each time you touch the screen or perform on the front panel.

Utility > **Setting** > **Beeper** , just set it on/off.

17.1.3 Screen Saver

A screen saver will be activated if the device has not been operated for a period. At this time the backlight of the display is cut off to save power consumption.

Execute **Utility** > **Setting** > **Screen Saver** , to specify the period before screen saver, or select "Off" to disable the screen saver.

The available screen saver waiting times are 1 minute, 5 minutes, 15 minutes, 30 minutes, 1 hour. You can also select 'Off' to disable the screensaver.

Any action from the mouse, touch screen, or front panel can disable the screen saver.

17.1.4 Keyboard Lock

Settings are made via **Utility** > **Setting** > **Keyboard** , to select “lock” or “unlock” the keyboard.

When set to "lock", the device has no response to any key operation on the front panel. To enable keyboard operation, set to “unlock” via the touch screen or remote control.

17.1.5 Auto Power-on

When the “Auto Power-on” option is enabled, once the device is connected to the AC power supply through the power cord, the device boots automatically. This is useful in automated or remote applications where physical access to the instrument is difficult/impossible.

Settings are made via **Utility** > **Setting** > **Auto Power-on** .

17.1.6 Date and Time

The SDG7000A has a real-time clock (RTC), which helps to record absolute time information for screenshots, history operations, and other file operations.

Execute **Utility** > **Setting** > **Time** or click the time/date display area in the upper right corner of the screen to enter the time/date setting page:

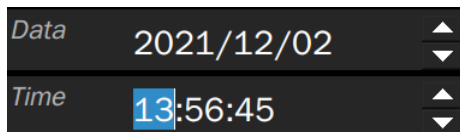

Touch the hour, minute, second, day, month, and year areas and adjust the values using the up and down arrows on the right side of the parameter setting box.

17.2 System Information

Execute **Utility** > **System Info** to check the system status. The system information includes the contents shown below:

System Info		2021/12/06 19:44:29
Startup Times:	161	
Software Version:	1.1.1.19	
Hardware Version:	01-00-FF-3-FF	
Product Type:	SDG7102A	
Serial Number:	SDG1XAAD4R0004	
OS Version:	05.02.20.05	
FPGA Version:	19-20211129	

17.3 Interface Settings

17.3.1 LAN Settings

Operate the following steps to set the LAN port:

Execute **Utility** > **Interface** > **LAN Settings** to enter the LAN configuration page:

A	<input type="radio"/> Obtain an IP address via DHCP	
B	<input checked="" type="radio"/> Specify an IP address	Apply
	IP Address:	10.11.13.220
	Subnet Mask:	255.255.255.0
	Gateway:	10.11.13.1
C	MAC:	0a : 0a : 36 : 0a : 08 : 99

- A** Select to enable dynamic IP. The device must be connected to a local area network with a DHCP server. Please contact your network administrator to confirm the information.
- B** Select to use a static IP. When selected, the device uses a static IP. Set the IP address, subnet mask, and gateway respectively, and then click Apply to confirm the configuration.
- C** MAC address information of the device, read-only

If you are still unable to access the LAN properly after the network port has been correctly configured, please contact your network administrator for assistance.

17.3.2 NET Storage Settings

Operate the following steps to set the NET Storage:

Execute **Utility** > **Interface** > **NET Storage Settings** to enter the NET Storage page:

- A** This option can only be selected after connecting to a network storage, Set the startup preset to last or user (see 17.5Pre-Setting for details), and restart to automatically connect to the network storage.
- B** Set the network storage disk path, consisting of the computer's IP and computer shared folder share name.
- C** When anonymous is not checked, you need to enter an account that can access computer shared folders.
- D** When anonymous is not checked, the login password corresponding to the account that can access the shared folder on the computer needs to be entered
- E** After checking, do not need to enter an account or password to access the shared folder (you need to enable the guest account on your computer and authorize the shared folder to the guest user)
- F** After checking, the path, account, and password will be remembered, need to set the startup preset to last or user (see 17.5Pre-Setting for details).
- G** Log in to access shared folders
- H** Disconnect Shared Folder

17.3.3 GPIB Settings

Execute **Utility** > **Interface** > **Gpib Address** to set gpib address:

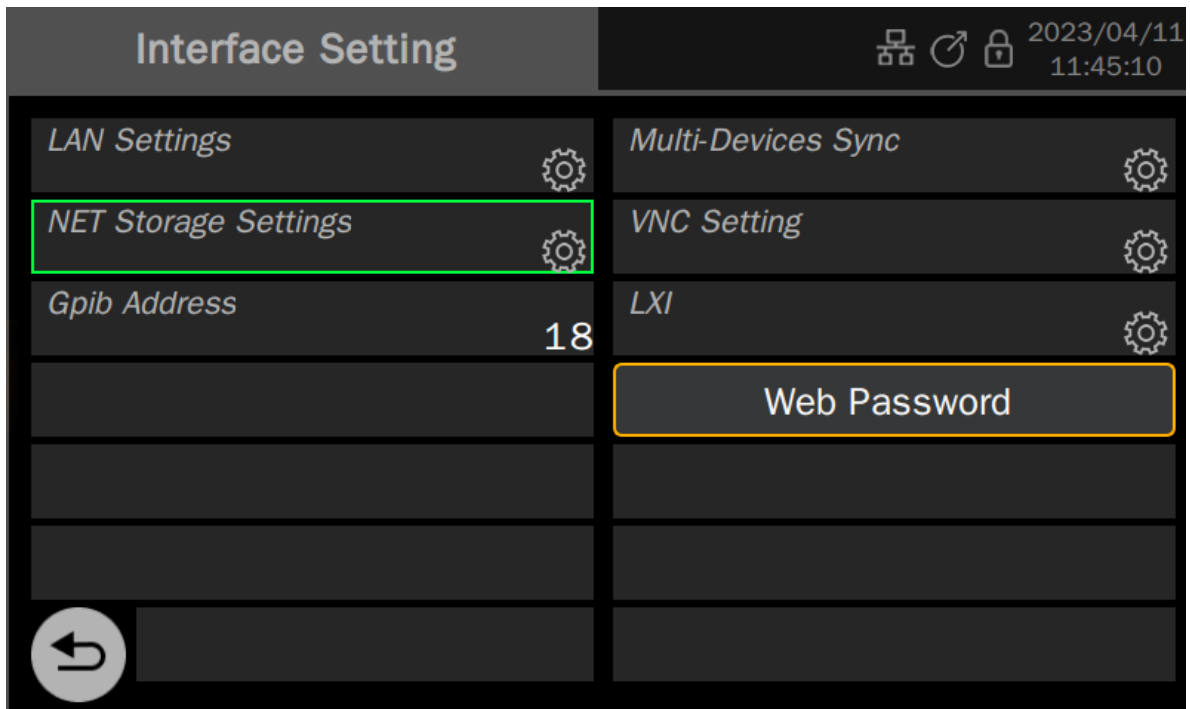

- Connecting devices

Connect SDG7000A to the computer using the USB-GPIB module (option). Please ensure that your computer has a GPIB card installed, and then connect the USB end of the USB-GPIB module to the USB Host interface on the SDG7000A front panel. Connect the GPIB end of the USB-GPIB module to the GPIB card port on the computer.

- Install GPIB card driver on the computer

Please install the GPIB card driver connected to the computer correctly.

- Set the GPIB address of the instrument

Execute **Utility** > **Interface** > **Gpib Address** to set gpib address, GPIB address can be set through buttons or touch screen.

- Remote communication with computers

Open the "Measurement&Automation Explorer" software, and after successfully adding the GPIB device, open the remote command control panel to send commands and read data through this panel.

17.3.4 Sync Output Settings



The TRIG/SYNC port on the rear panel is automatically set as the trigger input/output function when the frequency sweep or burst is turned on. In other cases, it is the sync output function by

default.

The device provides Sync output through the TRIG/SYNC connector on the rear panel. When the synchronization is on, the port will output a CMOS signal with the same frequency as basic waveforms (except Noise and DC), arbitrary waveforms, and modulated waveforms (except external modulation).

Execute **Utility** > **Interface** . Click the switch in the parameter setting box of "Sync Output" on the page of "Interface setting" to turn on/off synchronous output. You can select a synchronization source in the "Sync type" parameter setting box:

Table 17-1 Sync Type

Type of synchronization	Description
CH1	Carrier of CH1
CH2	Carrier for CH2
MOD-CH1	Modulated waveform of CH1
MOD-CH2	Modulated waveform of CH2



The upper limit of synchronization signal output frequency is 10 MHz. When the frequency of the synchronization source exceeds this value, the synchronization output will be turned off automatically.

Sync Signals of Different Waveforms:

- Basic Waveform and Arbitrary Waveform (AFG mode)
 - 1) When the frequency of the waveform is less-than or equal-to 10 MHz, the sync signal is a pulse with 25.6 ns pulse width and the same frequency as the waveform.
 - 2) When the frequency of the waveform is greater than 10 MHz, there is no sync signal output.
 - 3) Noise and DC: There is no sync signal output.
 - 4) PRBS: The frequency of the sync signal is the same as the bit rate of the waveform.
- Modulated Waveform
 - 1) When internal modulation is selected, the sync signal is a Pulse with 25.6 ns pulse width.
For AM, FM, PM, and PWM, the frequency of the sync signal is the modulating frequency.
For ASK, FSK, and PSK, the frequency of the sync signal is the key frequency.
 - 2) When external modulation is selected, there is no sync signal output, for the [Aux In/Out] connector on the rear panel is used to input the external modulating signal.
- Sweep and Burst Waveform

When Sweep or Burst function is turned on, there is no sync signal output and the Sync menu is hidden.

17.3.5 Multi-Device Synchronization

Synchronization of the frequency and alignment of the phase can be realized between two or more SDG7000A devices by utilizing the Multi-Device Sync function.

Execute **Utility** > **Interface** > **Multi-Device Sync** to set multi-device synchronization.

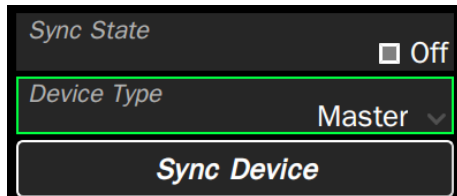

Setting parameters of the master

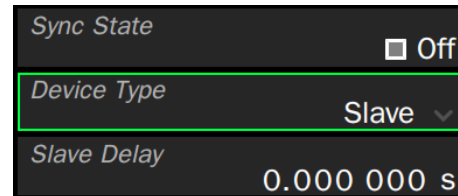

Setting parameters of the slave

The specific operation steps are as follows:

1. After entering the multi-device synchronization setting interface, set the "Sync Status" of all devices to "On".
2. Set one of the devices as "Master" and the other devices as "Slave".
3. Connect the [TRIG/SYNC] of the master to the [TRIG/SYNC] of other slaves respectively.
4. Connect the [10MHz Out] connector of the Master to the [10MHz In] connector of the first Slave, and then connect the [10MHz Out] connector of the first Slave to the [10MHz In] connector of the second slave, etc.
5. Set the same output frequency for all the generators.
6. Press the "Sync Device" button on the Master to apply synchronization.



Figure 17-1 wiring diagram of multi-device synchronization

The synchronous signal is transmitted from [TRIG/SYNC] of the Master to [TRIG/SYNC] of the Slave(s) through the BNC cable when Sync Devices is pressed. There is a certain delay between the moment when the master sends the synchronous signal and the moment when the Slave(s) receive it. Therefore, the output waveforms from different generators will have a certain phase difference related to the BNC cable. Users can adjust the phase of every Slave independently to compensate for the phase difference.

17.4 Test/Cal

17.4.1 Perform Self-Test

The Self-tests include a screen test, keyboard test, and LED test. It is used to check whether the device has any electrical or mechanical problems on the user interface such as color distortion, the sensitivity of buttons and knobs.

Execute **Utility** > **Test/Cal** > **Self Test** to enter self-test setting page.



Screen Test

The screen test is used to find out whether the generator display has serious color distortion, bad pixels, or screen scratches.

Execute **Utility** > **Test/Cal** > **Self Test** > **Screen Test**. The device enters the screen test interface as shown below, and the interface displays pure red.

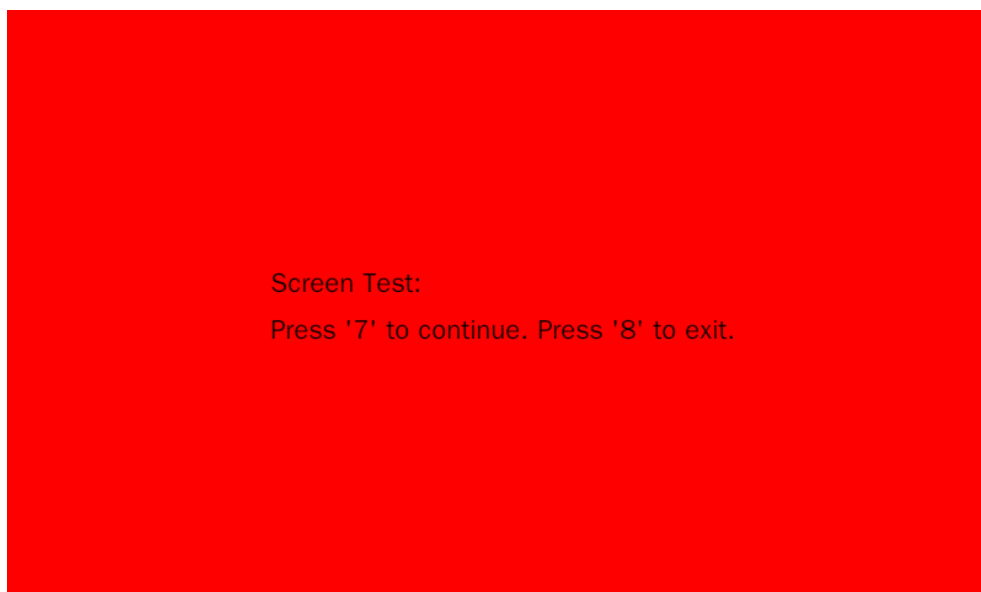

Press **7** to switch to green and blue screen display mode. Observe whether there is any color distortion, bad pixel or scratch on the screen.

Press **8** to exit the screen test mode.

Keyboard Test

The keyboard test is used to check whether the device's front panel buttons or knobs are responsive or sensitive.

Execute **Utility** > **Test/Cal** > **Self Test** > **Key Test** to enter the following interface:

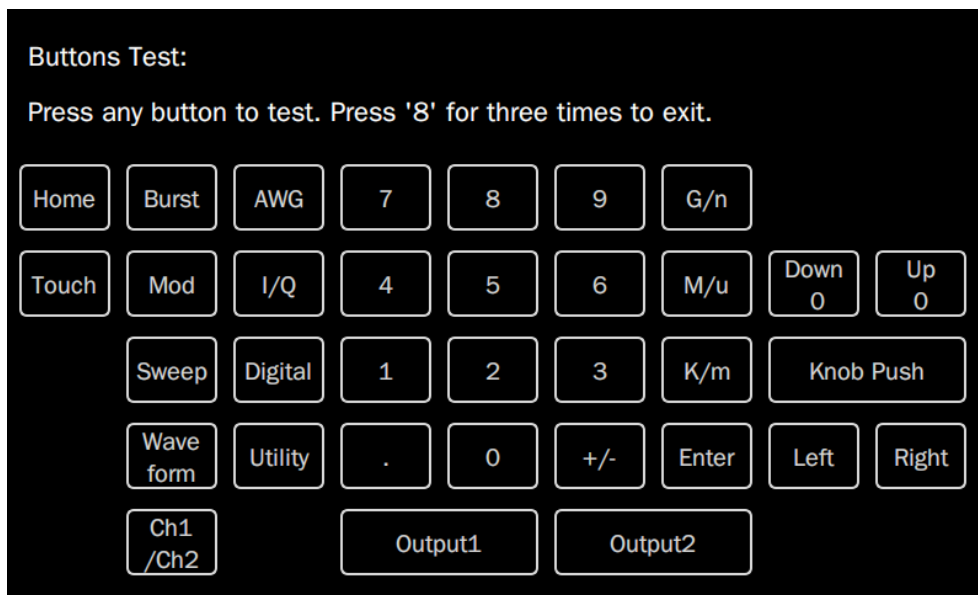

Knob test: Turn the knob clockwise, counter-clockwise, and press down. Observe whether the value on the corresponding knob (default 0) on the screen increases or decreases in real-time and whether the knob lights up when it is pressed.

Button test: Press each button and check whether the corresponding button icon on the screen lights up in real-time.

Press **8** button three times to exit the keyboard test.

LED Test

The LED test is used to check whether the button backlight on the front panel is functional.

Execute **Utility** > **Test/Cal** > **Self Test** > **LED Test**, and the device enters the following interface:

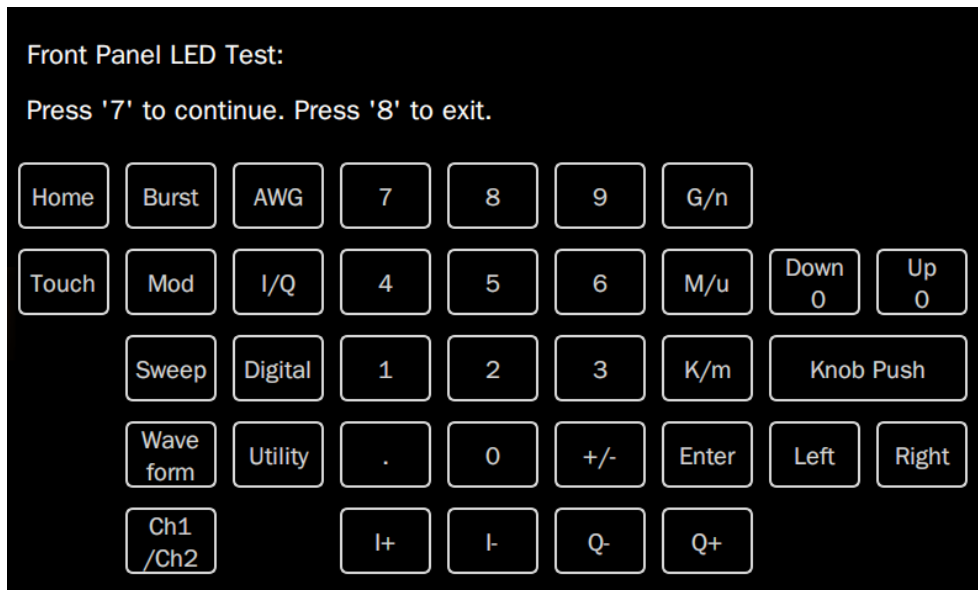

Press the **7** button and the first LED on the front panel will light. The corresponding position of the key on the screen will also change color. Press the **7** button to check the next button. Press the **7** button consecutively until all the backlights are tested.

Press the **8** button to exit the LED test.

Board Test

Board test mainly performs self inspection on some key chips of the device. When the device fails, this item can be executed to confirm whether it is caused by hardware failure.

Execute **Utility** > **Test/Cal** > **Self Test** > **Board Test** , and the device enters the interface shown below.

If "Pass" is prompted for all devices, it indicates that the key chips are working normally. Otherwise, it is necessary to restore the device to normal through maintenance.

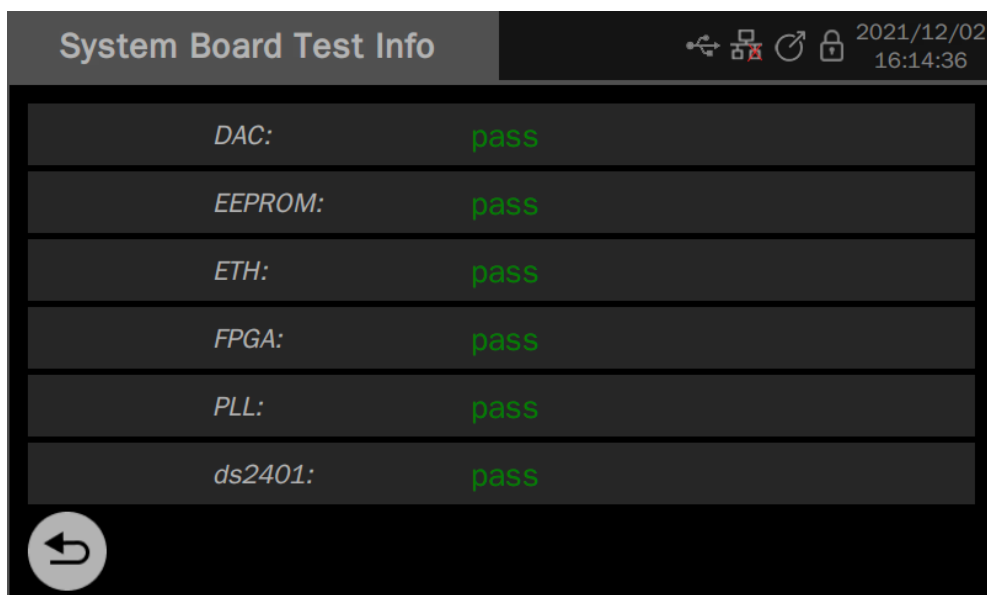

17.4.2 Perform Self-Calibration

The self-calibration program can quickly calibrate the generator to reach the best working state and the most accuracy. It is recommended to perform a self-calibration if the change of ambient temperature is more than 5 °C.

Note: Make sure the generator has been warmed up or operated for more than 30 minutes before performing the self-calibration process.

Please do the self-calibration as follows:

1. Disconnect all signal lines currently connected to the device.
2. After executing **Utility** > **Test/Cal** > **Self Cal**, the device pops up a prompt box and selects confirm to start the self-calibration procedure.
3. After the self-calibration starts, a progress bar will appear on the screen to display the self-calibration progress. During this process, pressing any other key of the device will not respond until the end of self-calibration.

The self-calibrated data will overwrite the last calibration data. The original correction value can be restored by loading the factory correction value. See the section "Loading Factory Calibration Data" for details.

17.4.3 Time Base Calibration

Time base calibration is used to adjust the time base inside the device to its most accurate state. This calibration requires the use of an external 10 MHz standard frequency source. The connection relationship is shown in the figure below. Connect the 10 MHz output of the frequency source to the frequency counter input of the device:

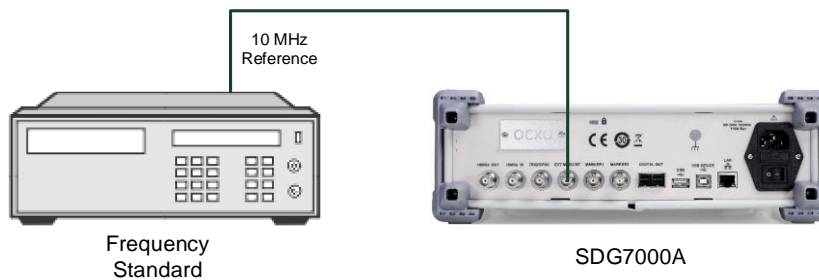
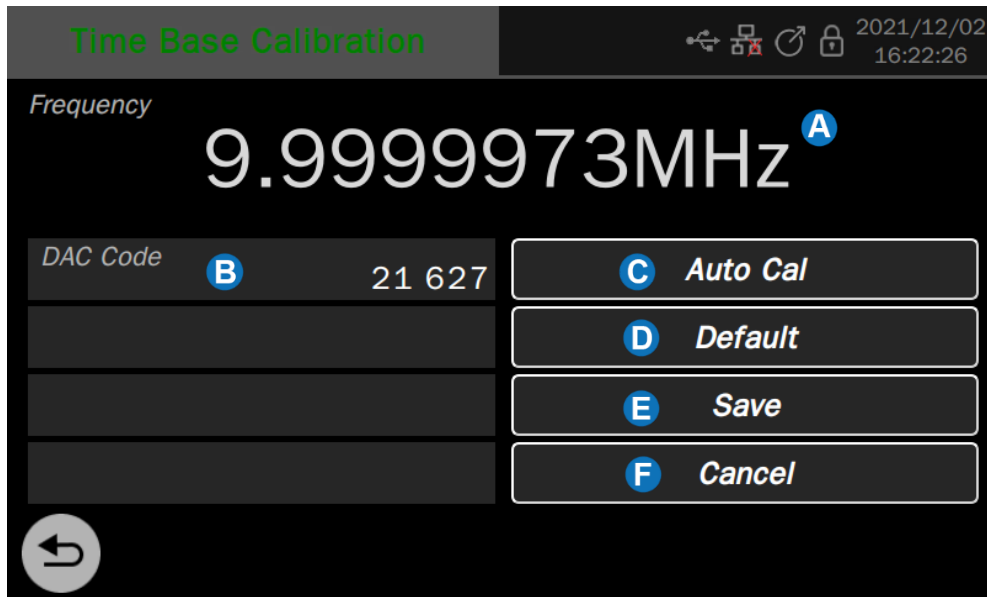

Figure 17-2 time base calibration environment

After configuring the calibration environment according to the above figure, ensure that the standard frequency source and the heat engine time of the device exceed the specified minimum time, execute **Utility** > **Test/Cal** > **TimeBase Cal** to enter the relevant setting page.



- A** Frequency values measured by frequency counter
- B** The DAC code value corresponding to the voltage control voltage of the current time base oscillator, where the code value can be entered for manual correction
- C** Perform automatic calibration
- D** Restore the default configuration
- E** Save the correction results
- F** Cancel this calibration

17.4.4 Loading Factory Calibration Data

Execute **Utility** > **Test/Cal** , and click the "Load" button in the "Default Cal data" parameter setting box to restore the factory calibration data.

17.5 Pre-Setting

The device provides a variety of preset modes.

Execute **Utility** > **Preset** to enter the relevant setup page. The following table is a description of each preset:

Table 17-2 Preset types

Preset type	Description
Restore default settings	Restore the factory preset default configuration
Recovering files	Configure the device according to the saved configuration file

Power-up settings	Default: factory preset default configuration loaded at power-up
	Last: loading the configuration before the last shutdown when powering up
	User: loads the configuration in the user-specified profile at power-up

17.6 Upgrade Software

Upgrade via USB Disk

The firmware is upgradeable through external USB memory devices/U disk. Make sure the U disk contains the correct upgrade file (*.ads) is connected to the device before performing the upgrade.

Execute **Utility** > **Update** to recall the upgrade dialog box:

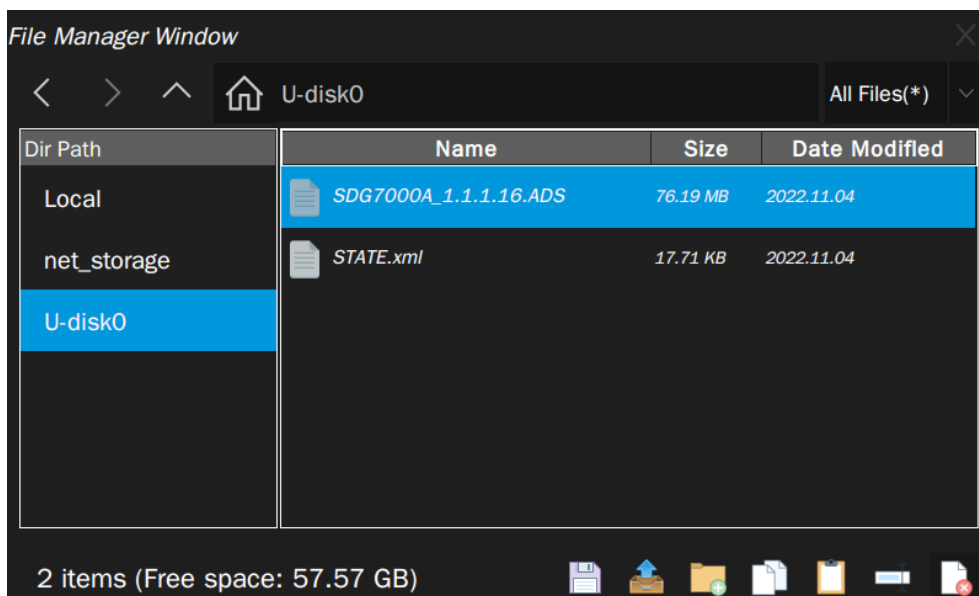

Select the correct ads file in the file manager and select  to start the upgrade. The device first copies the upgrade file (*.ads) to the local memory and parses it. If the parse succeeds, it will upgrade. After the updating is finished, the generator will restart automatically.

After restarting, please check the system status to confirm whether the version upgrade is successful. See the section "System Information" for details.

	Warning: Do not turn off the power during upgrading. Otherwise, the generator may not boot up any more! Repair for faulty upgrades is not covered under the warranty.
---	--

Upgrade via WebSever

See the section "Web Browser" for details.

17.7 Installation options

SDG7000A provides software options such as the I / Q and bandwidth upgrades to meet the measurement needs of users. Please contact SIGLENT sales personnel or technical support personnel to obtain the corresponding option license key. You can view the option information on the device or activate the newly purchased option license key.

Follow these steps to perform the option installation function:

Utility > Options

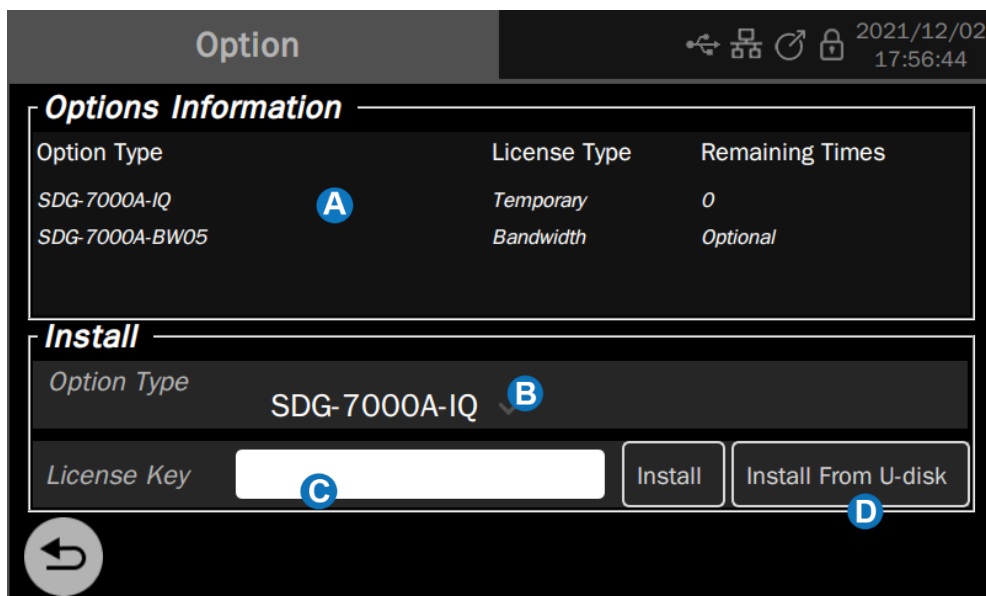

- A** Option information display area
- B** Option type selection. Select the option to install here
- C** Option key entry text box. Enter the key required to unlock the option here, and then click Install on the right to execute
- D** If the USB flash disk contains the obtained secret key file, you can directly click Install from a USB flash disk after inserting the USB flash disk to unlock it

17.8 Help

Execute Utility > Help to call the help system. The help document is equivalent to the contents of this user manual, and the browsing method is also similar.

18 Remote control

The SDG7000A provides a LAN port and a USB Device port which can be used for remote control in multiple ways.

18.1 Web Browser

A built-in web server provides an approach to control the generator by using a web browser. It doesn't require any additional software to be installed on the computer. Set the LAN port correctly (see section "LAN Settings" for details), input the IP address of the generator in the browser address bar, and then the user can browse and control the device in the web.

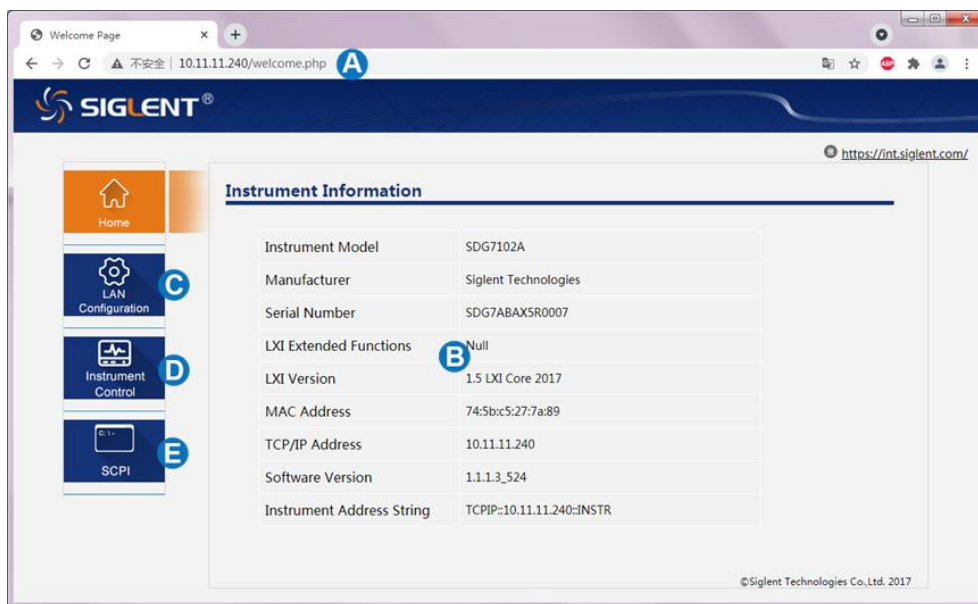

- A** Input the IP address of the generator
- B** Information of the generator
- C** Remote modification of device LAN parameters
- D** Click here to recall the device control interface
- E** SCPI Command Interaction Interface

The device control interface is shown below:

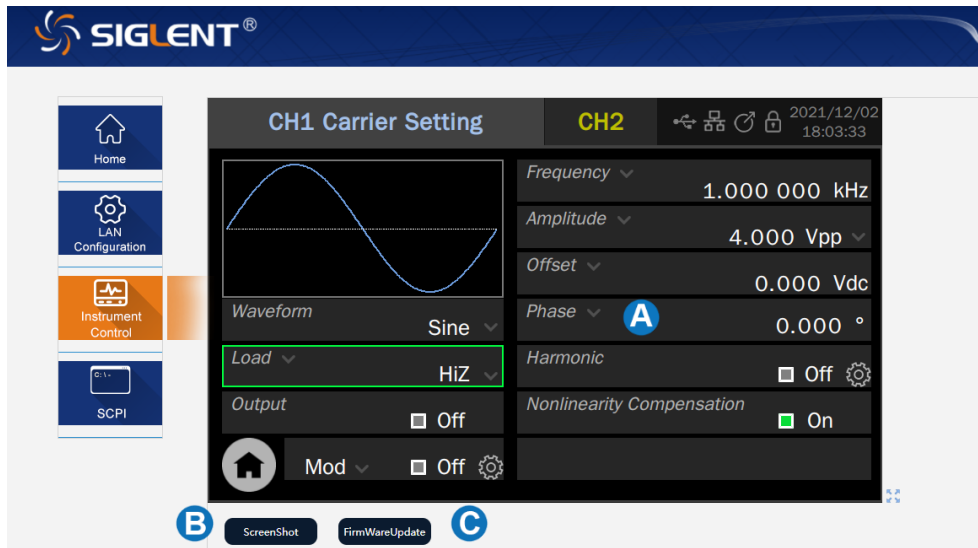

- A** Display and control area. The content displayed in this area is a copy of the touch screen display area of the device. Operating in this area with the mouse has the same effect as directly operating the touch screen display area of the device.
- B** Click to take the current screenshot.
- C** Click to upgrade the software version.

18.2 Other connections

The SDG7000A also supports remote control of the device by sending SCPI commands via NI-VISA, Telnet, or Socket. For more information, refer to the programming guide of this product.

19 Trouble Shooting

The following lists the possible faults and troubleshooting methods during the use of the device. When you encounter these faults, please follow the corresponding steps. If you can't handle them, please contact **SIGLENT** in time.

1. If the power key is pressed, the device remains black and there is no display.
 - 1) Check whether the power connector is connected properly
 - 2) Check whether the power switch is pressed correctly.
 - 3) Check whether the fuse is blown. If the power fuse needs to be replaced, please contact **SIGLENT** in time and return the instrument to the factory for replacement by the maintenance personnel authorized by **SIGLENT**.
 - 4) After the above inspection, please restart the device.
 - 5) If the product still can't be started normally, please contact **SIGLENT**.

2. No signal output
 - 1) Check whether the channel output is turned on.
 - 2) Check whether the signal cable is correctly connected to the BNC.
 - 3) Check whether the set amplitude output is too small.
 - 4) Check whether the digital filter of the channel is on and the cut-off frequency of the filter is lower than the set signal frequency.
 - 5) Check whether overvoltage protection or overcurrent protection occurs.
 - 6) Restore the default settings and try again.

3. The measured voltage amplitude is larger or smaller than the set value.
 - 1) Check whether the "Load" setting of the channel matches the actual load value.
 - 2) Check whether the "Waveform Combine" function is turned on.
 - 3) Check whether the "CHx Filter" of the channel is on and the Cut-off frequency of the filter is lower than or close to the set signal frequency.
 - 4) Restore the default settings and try again.

4. Two-channel output phase not aligned
 - 1) In the "Dual-Channel" setting, check whether the "Phase Mode" is correctly set to "Locked".
 - 2) In "Output Setting", check whether the "CHx Polarity" setting of each channel is inconsistent.
 - 3) Restore the default settings and try again.

5. The touch screen does not respond to touch operation

- 1) Check whether the Touch key light on the front panel is on. If not, it means that the touch screen is not turned on. Press this key to enable the touch screen.
 - 2) Reboot the device
6. Buttons do not respond to operation
- 1) Check whether the "KeyBoard" is set to "Lock". See the section "KeyBoard" for details.
 - 2) Reboot the device
7. USB device is not recognized
- 1) Check whether the USB device works normally.
 - 2) If it is a USB storage device, confirm that the flash USB disk is used, and the device does not support hard disk USB storage.
 - 3) Confirm that the USB flash disk system format used is FAT32.
 - 4) After restarting the device, insert the USB device for inspection.

If it still cannot be used normally, please contact **SIGLENT**.



About SIGLENT

SIGLENT is an international high-tech company, concentrating on R&D, sales, production and services of electronic test & measurement instruments.

SIGLENT first began developing digital oscilloscopes independently in 2002. After more than a decade of continuous development, SIGLENT has extended its product line to include digital oscilloscopes, isolated handheld oscilloscopes, function/arbitrary waveform generators, RF/MW signal generators, spectrum analyzers, vector network analyzers, digital multimeters, DC power supplies, electronic loads and other general purpose test instrumentation. Since its first oscilloscope was launched in 2005, SIGLENT has become the fastest growing manufacturer of digital oscilloscopes. We firmly believe that today SIGLENT is the best value in electronic test & measurement.

Headquarters:

SIGLENT Technologies Co., Ltd
Add: Bldg No.4 & No.5, Antongda Industrial
Zone, 3rd Liuxian Road, Bao'an District,
Shenzhen, 518101, China
Tel: + 86 755 3688 7876
Fax: + 86 755 3359 1582
Email: sales@siglent.com
Website: int.siglent.com

North America:

SIGLENT Technologies America, Inc
6557 Cochran Rd Solon, Ohio 44139
Tel: 440-398-5800
Toll Free: 877-515-5551
Fax: 440-399-1211
Email: info@siglent.com
Website: www.siglentna.com

Europe:

SIGLENT Technologies Germany GmbH
Add: Staetzlinger Str. 70
86165 Augsburg, Germany
Tel: +49(0)-821-666 0 111 0
Fax: +49(0)-821-666 0 111 22
Email: info-eu@siglent.com
Website: www.siglenteu.com

Follow us on
Facebook: SiglentTech

