

SDM4065A Series Digital Multimeter

User Manual

EN01A



SIGLENT TECHNOLOGIES CO.,LTD

Contents

1	Copyright and Statement.....	4
2	General Safety Summary	5
2.1	Safety Terms and Symbols	10
2.2	General Care and Cleaning.....	11
2.3	General Inspection.....	11
3	First Steps.....	12
3.1	Delivery Checklist.....	12
3.2	Quality Assurance	12
3.3	Maintenance Agreement.....	12
4	Document Conventions	13
5	Introduction of SDM4065A.....	14
6	Quick Start.....	16
6.1	Mechanical Dimension.....	17
6.2	To adjust the Handle.....	18
6.3	Front Panel.....	19
6.4	Rear Panel	21
6.5	Start the Multimeter	22
6.6	User Interface	23
6.7	Measurement Connections.....	24
6.8	Scanner Card.....	26
6.9	To Use the Built-in Help System.....	29
6.10	Replace the Power Fuse	30
7	Front Panel Operations	31
7.1	Measurement Configuration	32
7.1.1	Range.....	33
7.1.2	Aperture.....	34
7.1.3	DC Impedance.....	35
7.1.4	Auto Zero	36
7.1.5	AC Filter	37
7.1.6	Threshold Resistance.....	38

7.1.7	Threshold Voltage	39
7.1.8	Gate Time	40
7.2	Basic Measurement Functions	41
7.2.1	To Measure DC Voltage.....	42
7.2.2	To Measure AC Voltage	44
7.2.3	To Measure DC Current.....	46
7.2.4	To Measure AC Current.....	48
7.2.5	To Measure Resistance.....	50
7.2.6	To Measure Capacitance	53
7.2.7	To Measure Frequency and Period.....	55
7.2.8	To Measure Continuity	58
7.2.9	To Measure Diode	60
7.2.10	To Measure Temperature	62
7.2.11	User-defined Sensor Measurement	65
7.2.12	Scanner Card	68
7.3	Dual-display Function	74
7.4	Utility Function	77
7.4.1	Store/Recall.....	78
7.4.2	File Manager	83
7.4.3	I/O Configuration.....	84
7.4.4	Test Manager	89
7.4.5	System Setup.....	92
7.4.6	Date Time Edit.....	95
7.4.7	LXI.....	96
7.5	Trigger and Acquire	97
7.5.1	Sampling Rate	97
7.5.2	Acquire Mode.....	98
7.5.3	Trigger Source	105
7.5.4	VMC Out.....	108
7.5.5	Save Readings.....	108
7.6	Math Function	111
7.6.1	Statistics	112
7.6.2	Limits.....	114
7.6.3	dBm.....	116

7.6.4	dB	117
7.6.5	Relative Value.....	118
7.7	Display	119
7.7.1	Number.....	119
7.7.2	Bar	120
7.7.3	Trend	121
7.7.4	Histogram.....	122
7.7.5	Probe Hold.....	125
7.8	Help System.....	126
8	Measurement Tutorial	127
8.1	Loading Errors (DC Voltage).....	127
8.2	True RMS AC Measurement	128
8.3	Crest Factor Errors (Non-sinusoidal Input)	129
8.4	Loading Errors (AC Voltage)	130
9	Troubleshooting	131
10	Ordering Information	132

1 Copyright and Statement

Copyright

SIGLENT TECHNOLOGIES CO., LTD. All rights reserved.

Trademark Information

SIGLENT is registered trademark of SIGLENT TECHNOLOGIES CO., LTD.

Statement

- **SIGLENT** products are protected by patent laws in and outside of the P.R. China.
- **SIGLENT** reserves the rights to change the specification and price.
- Information in this publication replaces all previous corresponding published material.
- Contents in this manual are not allowed to be copied, extracted or translated in any form or by any means without **SIGLENT**'s permission.

2 General Safety Summary

Read the following safety precautions carefully to avoid any personal injuries or damages to the instrument and any products connected to it. To avoid potential hazards, please use the instrument as specified.

Use proper power line.

It's only allowed to use the special power line which is approved by local state. Unqualified rated cables cannot be used to replace detachable power cables.

Ground the instrument.

The instrument is grounded through the protective terra conductor of the power line. The ground conductor must be connected to the earth to avoid electric shock. Make sure the instrument is grounded correctly before connecting its input or output terminals.

Connect the signal wire correctly.

The potential of the signal wire is float to the earth, so do not touch the signal wire while connected to high voltage.

Observe all terminal ratings.

Please observe all ratings and sign instructions on the instrument to avoid fire or electric shock. Before connecting the instrument, please read the manual carefully to gain more information about the ratings.

Do not operate with suspected failures.

If you suspect that the product is damaged, please contact **SIGLENT**'s qualified service personnel to inspect it. Any repair and adjustment to the product or replacing a component should be done by qualified personnel only.

Avoid circuit or wire exposure.

Don't touch exposed contacts or components when the power is on.

Don't operate without covers.

Don't operate the instrument with covers or panels removed.

Use proper fuse.

It's only allowed to use the specified fuse for the instrument.

Use proper over-voltage protection.

Make sure there is no over-voltage (like voltage caused by thunder and lightning) reaching to the instrument, otherwise the operator may suffer an electric shock.

Antistatic protection.

Static electricity will cause damages to the instrument, so test in antistatic areas as far as possible. Ground its inner and outer conductors to release the static electricity temporarily before connecting the cable to the instrument.

Keep good ventilation.

Improper ventilation will cause the rise of the instrument's temperature. Keep good ventilation and check the vent and fan regularly when using it.

Keep the surface of the instrument clean and dry.

Do not operate in wet or damp conditions.

Do not operate in flammable or explosive environment.

Instructions not to position the equipment so that it is difficult to operate the disconnecting device.

The disturbance test of all the models meets the limit values of A in the standard of EN 61326-1:2013 and UL 61010-2-030:2018.

Statement of the range of environmental conditions

Indoor or Outdoor Use	Indoor use
Altitude	2000 meters MAX
Temperature	0°C ~ 50°C
Relative Humidity	0% ~ 60%
Power Supply	AC 200 V ~ 240 V 50/60 Hz or AC 100 V ~ 120 V 50/60 Hz, 30 VA MAX
Mains Supply Voltage Fluctuations	±10%
Overvoltage Category	10%
Wet Locatiосn, if Applicable	Dry location
Pollution Degree of the Intended Environment	II

Input terminal protection limitation

Protection limitation is defined for the input terminal:

1. Main input (HI and LO) terminal

HI and LO terminals are used for Voltage, Resistance, Capacitance, Continuity, Frequency, Diode and temperature measurement. Two protection limitations are defined:

- HI-LO protection limitation: 1000 VDC or 750 AVC. It's the maximum measurable voltage. The limitation can be expressed as 1000Vpk.
- LO-ground protection limitation: LO terminal can "float" 400 Vpk relative to the ground safely. The maximum protection limitation of HI terminal relative to the ground is 1000 Vpk. Therefore, the sum of the "float" voltage and the measured voltage can't exceed 1400 Vpk.

2. Sampling (HISense and LOSense) terminal

HISense and LOSense are used for 4-wire Resistance measurement. Two protection limitations are defined:

- HISense-LOSense protection limitation: 200 Vpk.
- LOSense-LOSense protection limitation: 2 Vpk.

3. Current input (I) terminal

I and LO terminals are used for current measurement. The maximum current which goes through the I terminal is limited to 10 A by the internal fuse of the instrument. This fuse is a fast melting, explosion-proof, 10 A, 1000 V, 10.3x38 mm fuse.

NOTE:

Voltage on the current input terminal corresponds to voltage on LO terminal. To keep good protection, only use the fuse of specified type and level to replace this fuse.

IEC Measurement Category II Overvoltage Protection

SDM4065A Digital Multimeter provides overvoltage protection for line-voltage mains connections meeting both of the following conditions to avoid the danger of electric shock:

1. The HI and LO input terminals are connected to the mains under Measurement Category II conditions as following.
2. The maximum line voltage of the mains is 300 VAC.

WARNING:

IEC Measurement Category II includes electrical devices connected to mains at an outlet on a branch circuit, such as most small appliances, test equipment, and other devices that plug into a branch outlet or socket.

SDM4065A is capable of making measurements with the HI and LO inputs connected to mains in such devices or the branch outlet itself. However, the HI and LO terminals of SDM4065A can't be connected to mains in permanently installed electrical devices such as the main circuit-breaker panels, sub-panel disconnected boxes and permanently wired motors. Such devices and circuits are prone to exceed the protection limits of SDM4065A.

NOTE:

Voltages above 300 VAC only can be measured in circuits that are isolated from mains. However, there may be transient overvoltage in circuits that are isolated from mains. SDM4065A is able to withstand occasional transient overvoltage up to 2500 Vpk. Please don't use this instrument to measure circuits that transient overvoltage may exceed this level.

2.1 Safety Terms and Symbols

Terms in this manual. Terms may appear in this manual:



WARNING:

Warning statements indicate the conditions and behaviors that could result in injury or loss of life.



CAUTION:

Caution statements indicate the conditions and behaviors that could result in damage to this product or other properties.



CAT I (1000 V)

IEC Measurement Category I. The maximum measurable voltage at the HI-LO terminal is 1000 Vpk.



CAT II (300 V)

IEC Measurement Category II. Inputs may be connected to mains (up to 300 VAC) under Category II overvoltage conditions.

Terms used on the instrument. Terms may appear on the instrument:

DANGER indicates an injury or hazard that may immediately happen.

WARNING indicates an injury or hazard that may not immediately happen.

CAUTION indicates that a potential damage to the instrument or other property might occur.

Symbols used on the instrument. Symbols may appear on the instrument:



Hazardous
Voltage



Warning



Protective
Earth Ground



Test Ground



Chassis
Ground



ETL Logo

2.2 General Care and Cleaning

Care:

Do not store or leave the instrument in direct sunshine for extended periods.

To avoid damage to the instrument or probes, please do not expose them to fog, liquid, or solvents.

Cleaning:

Please often clean the instrument and test leads according to the use of them.

- Wipe the external ash of the instrument and test leads by a soft rag. Be careful not to scratch the transparent plastic protective screen when cleaning the liquid crystal screen.
- Use a soft rag that has been soaked by water to clean the instrument after cutting off the power. Or use 75% isopropyl alcohol of water solvent to get a more thorough cleaning.

NOTE:

- To prevent the surface of the instrument or test leads from damages, please don't use any corrosive or chemical cleaning reagents.
- Please make sure the instrument is already dry before restarting it to avoid short circuits or personal injuries caused by water.

2.3 General Inspection

• Inspect the shipping container

Keep the original shipping container and cushioning material until the contents of the shipment have been completely checked and the instrument has passed both electrical and mechanical tests.

The consigner or carrier will be responsible for damages to the instrument resulting from shipment. **SIGLENT** will not provide free maintenance or replacement if the instrument has been damaged in shipment.

• Inspect the instrument

If there are instruments found damaged, defective, or have failed any electrical and / or mechanical tests, please contact **SIGLENT**.

• Check the accessories

Please check the accessories according to the packing list. If the accessories are incomplete or damaged, please contact your **SIGLENT** sales representative.

3 First Steps

3.1 Delivery Checklist

First, verify that all items listed on the packing list have been delivered. If you note any omissions or damage, please contact your nearest **SIGLENT** customer service center or distributor as soon as possible. If you fail to contact us immediately in case of omission or damage, we will not be responsible for replacement.

3.2 Quality Assurance

The oscilloscope has a 3-year warranty (1-year warranty for probe and accessories) from the date of shipment, during normal use and operation. **SIGLENT** can repair or replace any product that is returned to the authorized service center during the warranty period. We must first examine the product to make sure that the defect is caused by the process or material, not by abuse, negligence, accident, abnormal conditions, or operation.

SIGLENT shall not be responsible for any defect, damage, or failure caused by any of the following:

- a) Attempted repairs or installations by personnel other than **SIGLENT**.
- b) Connection to incompatible devices/incorrect connection.
- c) For any damage or malfunction caused by the use of non-**SIGLENT** supplies. Furthermore, **SIGLENT** shall not be obligated to service a product that has been modified. Spare, replacement parts and repairs have a 90-day warranty.

The oscilloscope's firmware has been thoroughly tested and is presumed to be functional. Nevertheless, it is supplied without a warranty of any kind covering detailed performance. Products not made by **SIGLENT** are covered solely by the warranty of the original equipment manufacturer.

3.3 Maintenance Agreement

We provide various services based on maintenance agreements. We offer extended warranties as well as installation, training, enhancement and on-site maintenance, and other services through specialized supplementary support agreements. For details, please consult your local **SIGLENT** customer service center or distributor.

4 Document Conventions

For convenience, text surrounded by a box border is used to represent the button of the front panel. For example, **Function** represents the "Function" button on the front panel. Text with character shading is used to represent menus, options, and virtual buttons that can be touched by your finger or clicked on by the mouse on the display screen. For example, **Acquire** represents the "Acquire" menu on the display screen.

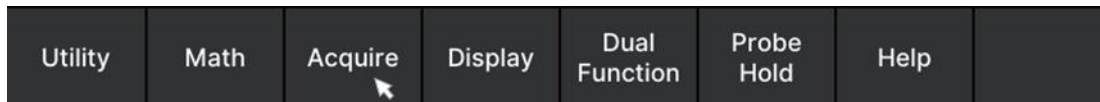

For the operations that contain multiple steps, the description is in the form of "Step 1 > Step 2 >...". As an example, follow each step in the sequence to enter the LCD test interface:

Utility > **Test Manager** > **LCD Test**

Press the **Utility** button on the front panel as step 1, click the **Test Manager** option on the screen as step 2, and click the **LCD Test** option on the screen as step 3 to enter the LCD test interface.

The precautions in this article provide important information, each of which is indicated by the icon



5 Introduction of SDM4065A

SDM4065A is a 6½ dual-display instrument, especially fitting to the needs of high-precision, multifunction, and automation measurements. It realized a combination of basic measurement functions, multiple math functions, and display functions, etc.

SDM4065A holds a TFT-LCD display screen with 480*800 high resolutions. Its clear keyboard layout and operation hints make it easier and agility to use. Besides, it supports multi-interface such as USB Device, USB Host, LAN and USB-GPIB (optional), which can meet users' demand furthest.

Main Features:

- Real 6½ digits readings resolution.
- Minimum aperture: 0.001 PLC.
- Dual display function: synchronously display two kinds of characteristics of the same signal.
- DC voltage measurement range: 200 mV~1000 V.
- DC current measurement range: 200 μA~10 A.
- AC voltage measurement range: True-RMS, 200 mV~750 V.
- AC current measurement range: True-RMS, 200 μA~10 A.
- Resistance measurement range: 200 Ω~100 MΩ; support 2-wire (2WR) and 4-wire (4WR) resistance measurements.
- Capacitance measurement range: 2 nF~100 mF.
- Frequency measurement range: 3 Hz~1 MHz.
- Continuity and Diode tests.
- Thermocouple and thermistor temperature sensor testing function, with built-in cold terminal compensation for thermocouple.
- Plenty of math operations such as Max, Min, Average, Standard deviation, Limits, dB/dBm and Relative value; support bar, trend and histogram display functions.
- Enable to store data and configuration in U disk.
- Support USB Device, USB Host, LAN, and GPIB (optional) interfaces.
- Support 16 channels scanner card, provide effective solutions for multi-point testing and multi signal measurement (optional).
- Support standard SCPI and control software on PC, compatible with the latest widely used multimeter command sets.
- Equipped with upper computer software, which can control the device and scanner card through the upper computer.

- Support recording and saving historical measurement results.
- 256 MB Nand Flash, supports storage of various types of files such as readings, images, configuration files.
- Provide Chinese and English menu, and built-in help system for easy information retrieval.
- Support an intelligent laboratory management system based on BS architecture and LAN connection, with hardware compatible with the original experimental system for secondary development.

6 Quick Start

This chapter introduces the preparation work for using the SDM4065A digital multimeter, and introduces the front panel, rear panel, display screen, etc. of the digital multimeter.

This chapter contains the following topics:

- Mechanical Dimension
- To adjust the Handle
- Front Panel
- Rear Panel
- Start the Multimeter
- User Interface
- Measurement Connections
- Scanner Card
- To Use the Built-in Help System
- Replace the Power Fuse

6.1 Mechanical Dimension

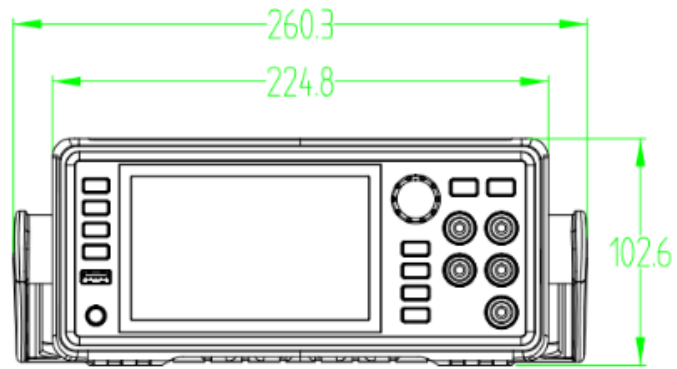

Front View

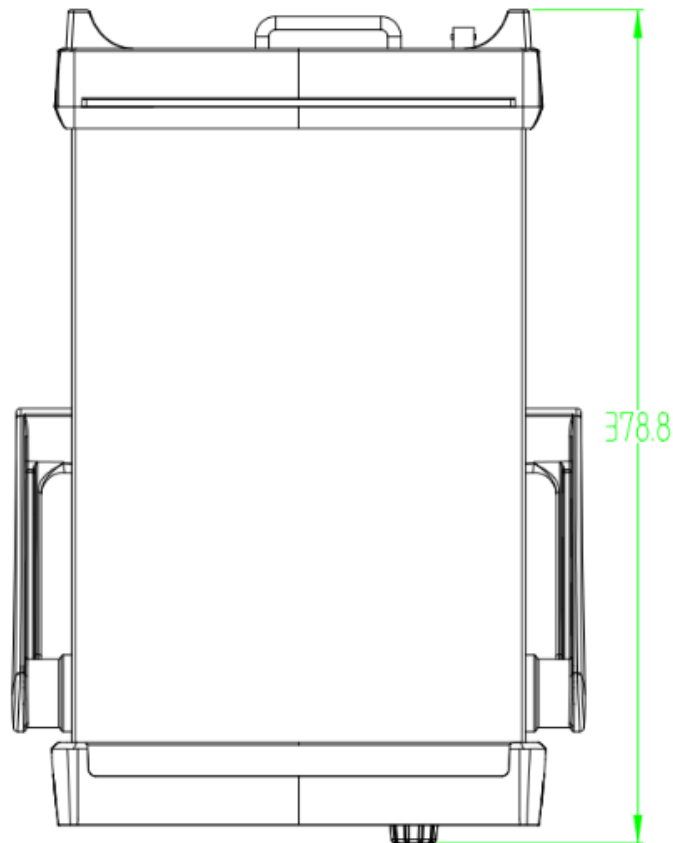

Top View

Unit: mm

6.2 To adjust the Handle

Please grip the handle by the two sides and pull it outward to adjust the handle position of SDM4065A. Then rotate the handle to the appropriate position. Please operate as the following figure:

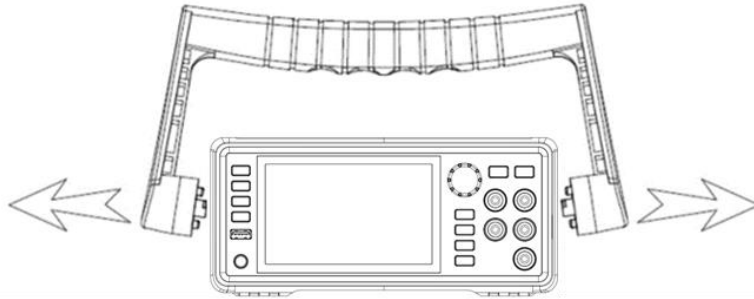

Handle Adjustment

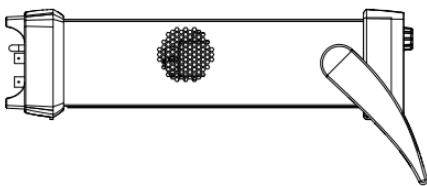
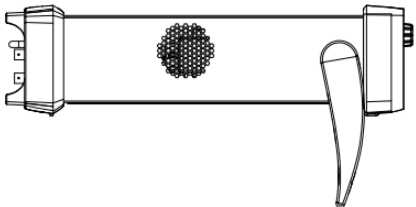
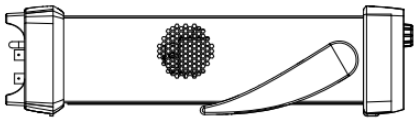

Viewing Position

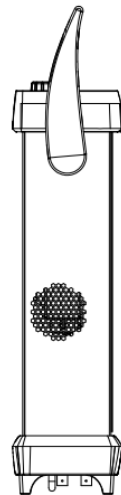

Carrying Position





6.3 Front Panel

The SDM4065A digital multimeter provides users with a simple and clear front panel. These buttons are grouped and arranged according to their functions, and corresponding buttons can be selected for relevant operations, as shown in the following figure:



- A. **Power Key** Short/long press the key to turn on/off the instrument.
- B. **USB Host** By using this interface, you can store the current state or measurement data into USB storage device, and you can also read the state files or updated firmware from USB storage device.
- C. **Menu Operation Buttons** Press any softkey to activate the corresponding menu.
- D. **Touchable Display Screen** Display the menu and measurement parameter settings for the current function, system status, and prompt messages. Related operations can be achieved by touching the screen area with your fingers.
- E. **Knob**
- F. **Trigger and Measurement Function Buttons**
- G. **Left/Right Directional Buttons** Move the cursor, with the same function as counterclockwise or clockwise rotation of the knob.
- H. **Signal Input Terminals** The measured signal (device) will be connected into the multimeter through these terminals. Different measurement functions have different connections methods. For details, please refer to “Measurement Connections”.

Menu Operation Buttons



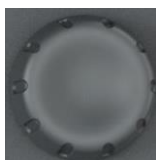

-  Measurement menu button, which can set measurement functions and corresponding parameters related to the functions.
-  Function selection menu button, which can select or set parameters about Utility, Math, Acquire, Display, Dual Function, Probe Hold and Help.
-  System function menu button, which can set the system functions about Store/Recall, File Management, I/O Config, Test Management, System Setting and Date Time Edit.
-  Provide help information.





Knob



Rotate the knob clockwise/counterclockwise to move the cursor, press down to select the menu item where the cursor is located or turn on/off the menu item function.

Trigger and Measurement Functions Buttons

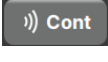
-  Single Trigger.
-  Auto Run/Stop.
-  Set up functions such as Acquire, Trigger Setting, VMC Out, and Save Readings.
-  Open the measurement function selection menu to select the following measurement functions:

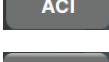
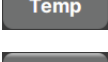
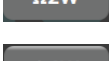
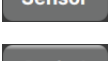
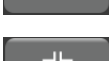
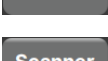
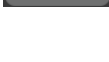
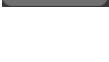
 DCV	DC voltage measurement	 Freq	Frequency measurement
 ACV	AC voltage measurement	 Cont	Continuity measurement
 DCI	DC current measurement		Diode measurement
 ACI	AC current measurement	 Temp	Temperature measurement
 Ω2W	2-wire resistance measurement	 Sensor	Sensor measurement
 Ω4W	4-wire resistance measurement	 Period	Period measurement
	Capacitance measurement	 Scanner	Enable scanner card function

6.4 Rear Panel

The rear panel of the SDM4065A digital multimeter provides users with rich interfaces, as shown in the figure:



- A. **Power Socket** The multimeter accepts two types of AC supplies. Please use the power cord provided in the accessories to connect the multimeter to the AC power through this socket.
Note: A proper voltage scale must be first selected (through the Voltage Selector) before power connection.
- B. **Power Fuse**
- C. **AC Voltage Selector** Select a proper voltage scale (110 V or 220 V) according to the AC supply used.
- D. **Scanner Card (Option)** An optional 16 channels scanner card can be installed in the instrument.
- E. **USB Host**
- F. **USB Device** Connect the PC through this interface. You can use SCPI commands or PC software to control SDM4065A remotely.
- G. **LAN** Through this interface, the multimeter can be connected to the network for remote control.
- H. **VMC Output** The multimeter outputs a 5V pulse from this port every time it completes a sampling.
- I. **Ext Trigger** Trigger the multimeter by connecting a trigger pulse through the [EXT TRIG] connector. Note the external trigger source must be selected.
- J. **Instrument Lock Hole** You can use the safety lock (please purchase it yourself) to lock the multimeter in a fixed place if necessary.

6.5 Start the Multimeter

Before connect the instrument to a power source, please select the AC voltage in the AC voltage selector on the rear panel of your multimeter according to the power supply. Then connect the power cord as shown in the following figure.

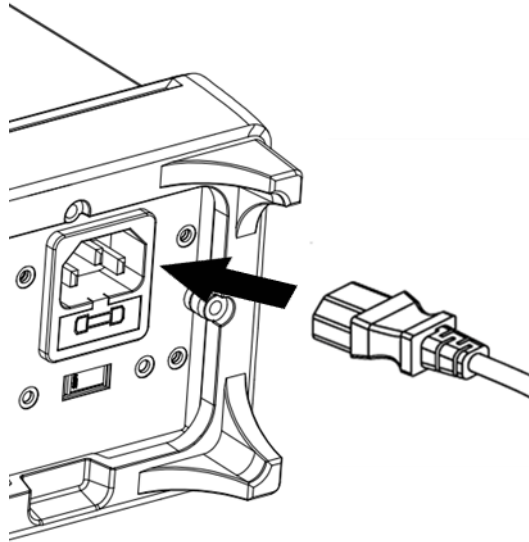



Connect Power Cord

Press the Power key on the front panel to start up the multimeter. If the multimeter does not start normally, please refer to the relevant content and steps of the “Troubleshooting” for inspection.

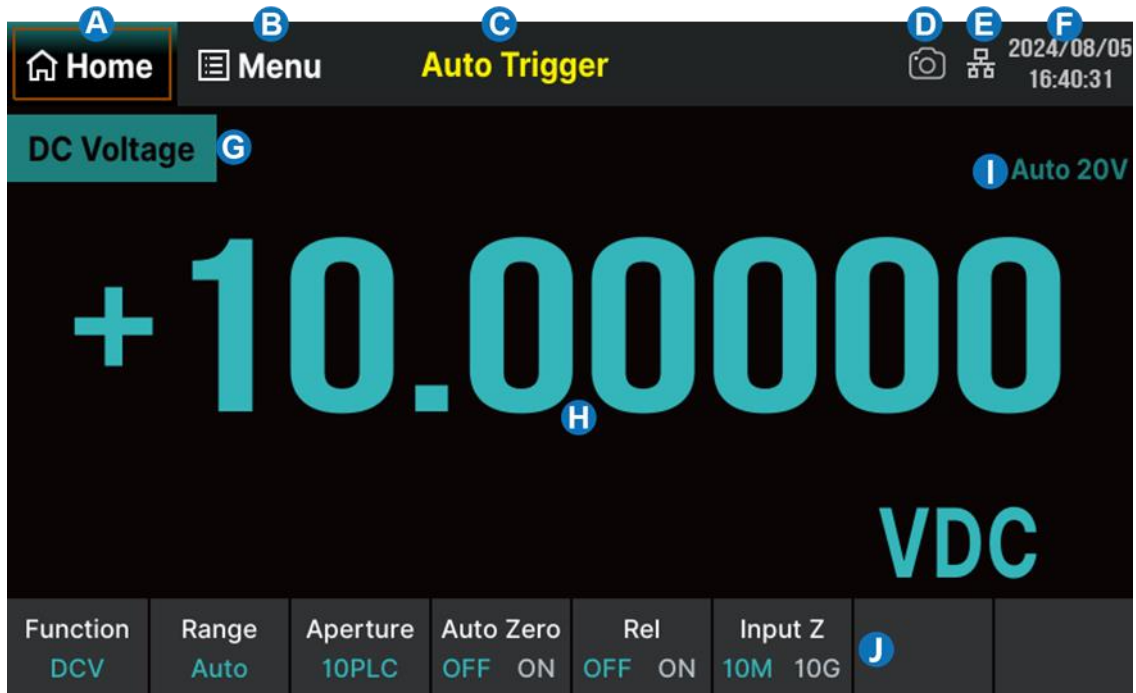
6.6 User Interface



- A. Home. Functionally equivalent to the "Home" button on the left side of the front panel
- B. Menu. Functionally equivalent to the "Menu" button on the left side of the front panel
- C. Trigger mode
- D. Quick screenshot identification
- E. LAN status icon.  indicates that the LAN cable is connected,  indicates that it is not connected; Click on this icon to set LAN
- F. Date and time display area. Display the current date and time, click to make settings
- G. Measurement function
- H. Measurement result
- I. Current range in use
- J. Operation menu. Select the measurement function and set the parameters for this function

6.7 Measurement Connections

SDM4065A is designed with many measurement functions. After selecting the desired measurement function, please connect the signal (device) under test to the multimeter according to the method below.

DC Voltage Measurement (DCV)

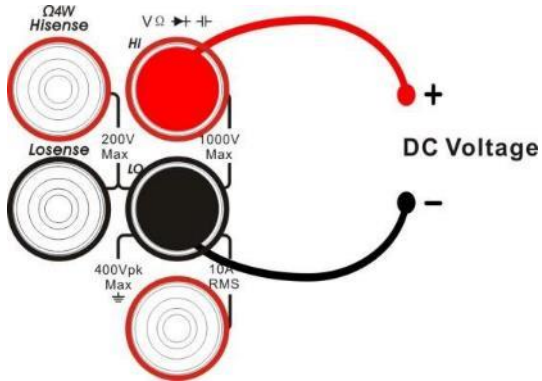

AC Voltage Measurement (ACV)

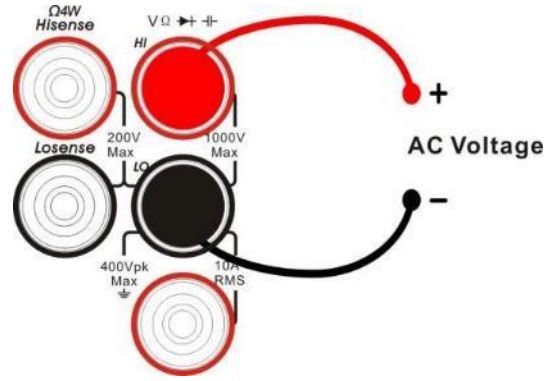

DC Current Measurement (DCI)

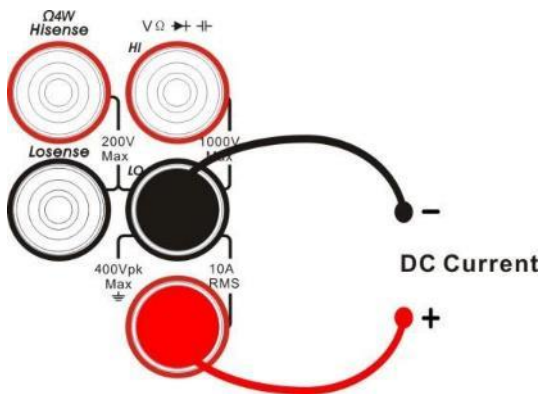

AC Current Measurement (ACI)

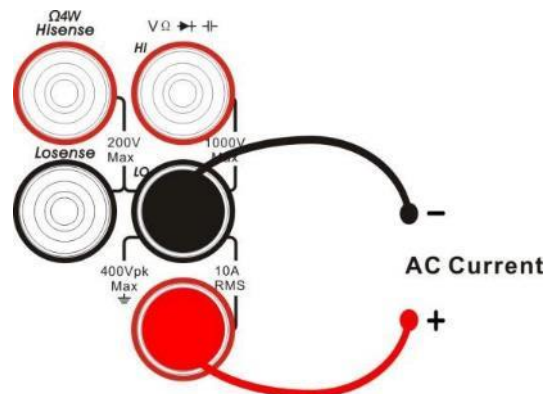

2-Wire Resistance Measurement (2WR)

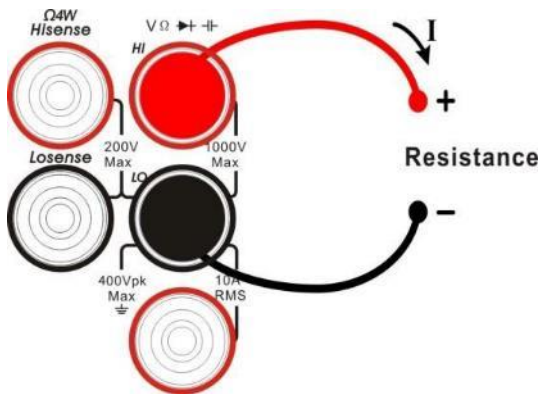

4-Wire Resistance Measurement (4WR)

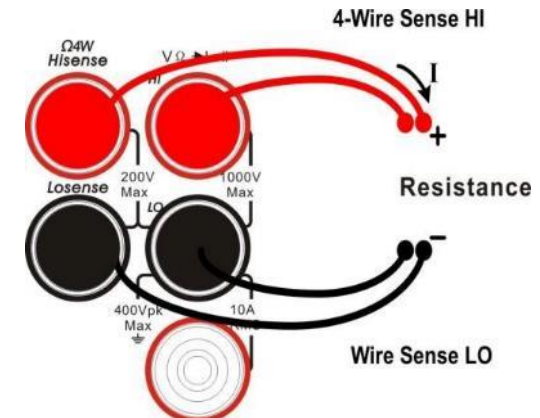

Capacitance Measurement (Cap)

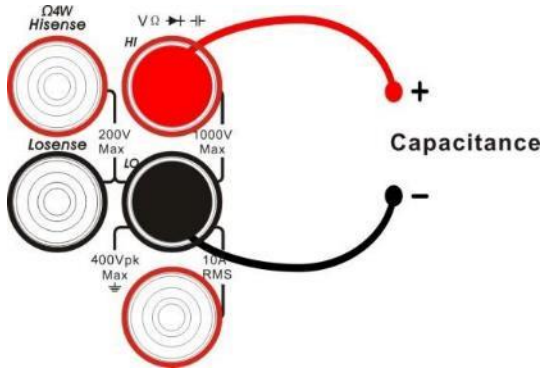

Frequency/period Measurement (Freq/Period)

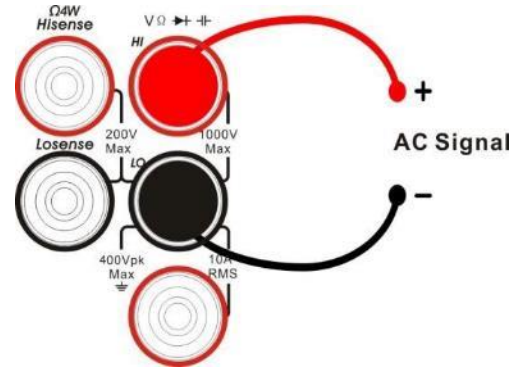

Continuity Measurement (Cont)

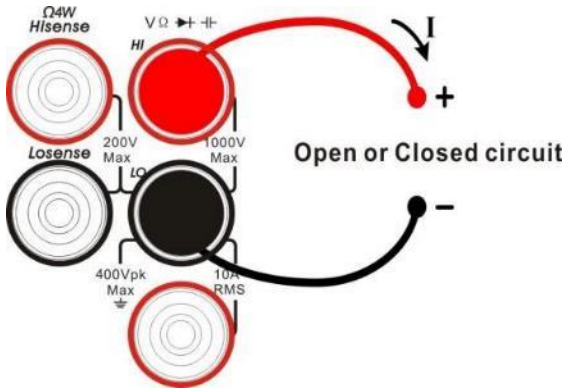

Diode Measurement (Diode)

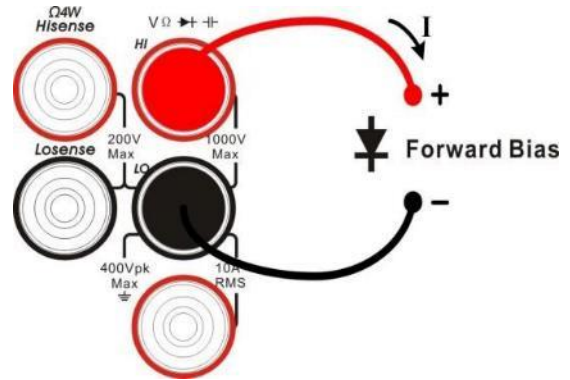

Temperature Measurement (Temp) (For RTD and thermocouple sensors)

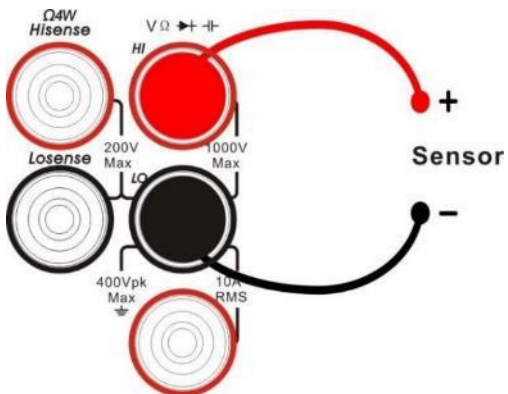

6.8 Scanner Card

The SDM4065A-SC in this multimeter supports 16 channel external inspection card for multi-point and multi signal testing.

Table 6-1 Scanner Card SC1016 measurement and test line connection

Items	No. of wires	Number of channels
DCV, ACV ^[1]	2 wires (H, L)	12 (CH1~CH12) (125 VAC, 110 VDC)
DCI, ACI ^[2]	2 wires (H, L)	4 (CH13~CH16)(2 A range only)
2-Wire R, etc. ^[3]	2 wires (H, L)	12 (CH1~CH12)
4-Wire R	4 wires (H, L, HS, LS)	6 (CH1~CH6 for HI/LO) (CH7~CH12 for HS/LS)

Notes:

- [1] In 200 V range, the input signal is limited to 125 VAC and 110 VDC.
- [2] Continuous current limited: < 2.2 A. Accuracy: \pm (% 3 of reading+0.02% of range).
- [3] There are capacitance, diode, continuity, frequency/period, temperature (thermocouple) and temperature (2-Wire RTD). The No. of wires and the No. of channels are the same with 2-Wire resistance.

Operation Steps:

1. Scanner Card Installation

- 1) Turn off the power and pull out the power cord.

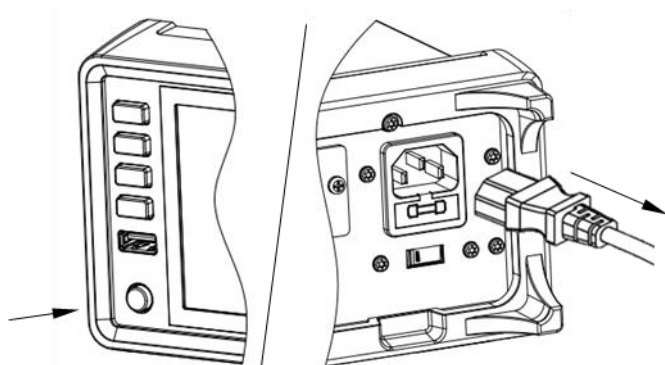

- 2) Unscrew the two screws and take out the cover plate of the slot.

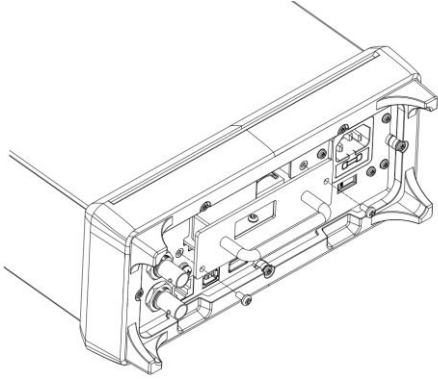

- 3) Press the connector button with your finger, and then insert the connecting line.

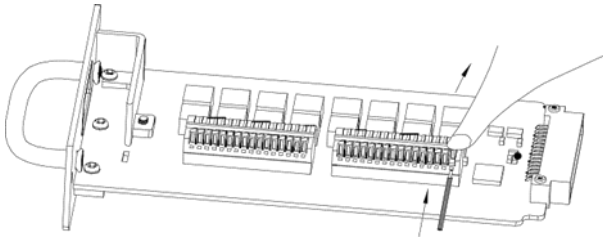

- 4) Lead out the connecting line from the opening of the cover plate as shown in the figure, and then fix the connecting line on the cable fixing base.

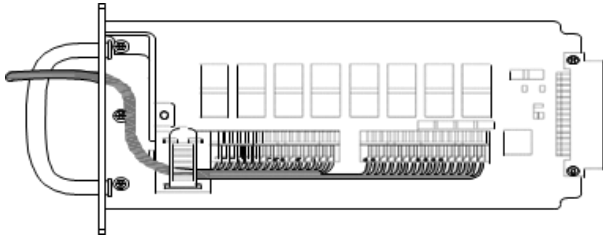

- 5) Insert the scanner card SC1016 into the body along the guide rail, and lock the two screws again.

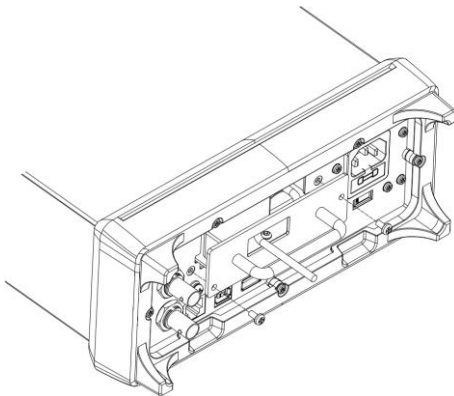

- 6) Plug in the power cord and turn it on.

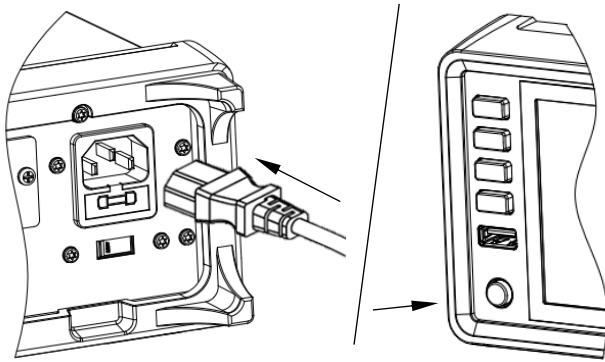

2. Measurement connection method

- 1) 2-wire measurement mode ^[1] (voltage, current, 2-W resistance, capacitance, frequency/period, continuity, diode, temperature).

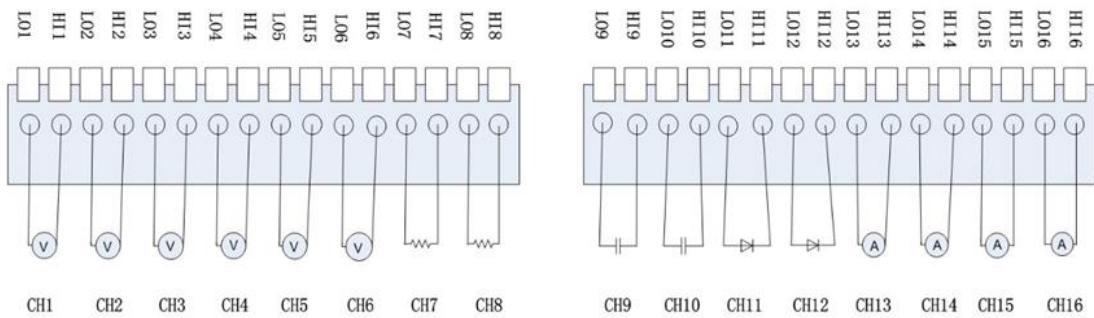

Note:

- [1] Each channel of CH1~CH12 can be used for switching measurement of voltage, 2-W resistance, capacitance, frequency, continuity, diode, temperature, etc. CH13~CH16 channels are fixed for current measurement below 2.2 A.

- 2) 4-wire measurement mode

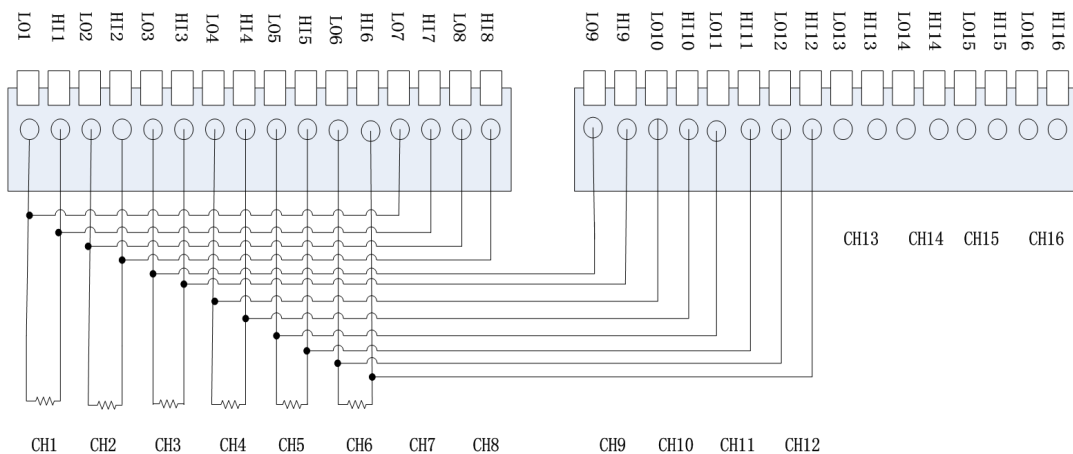

6.9 To Use the Built-in Help System

To obtain the built-in help information for this product, select the item that needs help, press the **Help** button to enter the help system interface, and view the corresponding help information.

The built-in help information is listed as the following:

1. Basic measurement
2. Math function
3. Dual display function
4. Save and recall
5. Teach support

6.10 Replace the Power Fuse

The multimeter is already installed with a power fuse (0218.315MXP) before leaving factory. This fuse is a slow melting, explosion-proof, 315 mA, 5x20 mm fuse. If you need to replace the fuse, please follow the steps below to replace it:

- 1) Turn off the multimeter and remove the power cord.
- 2) Press down the block tongue using a straight screwdriver (in the direction of the dotted arrow in the figure) and pull out of the fuse seat.
- 3) Select a proper voltage scale.
- 4) Replace a specified fuse.
- 5) Reinstall the fuse seat into the slot.

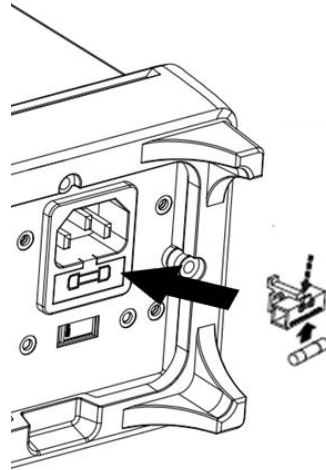

Replace the Power Fuse

7 Front Panel Operations

This chapter introduces how to use the functions of the multimeter from the front panel.

The chapter contains the following topics:

- Measurement Configuration
- Basic Measurement Functions
- Dual-display Function
- Utility Function
- Trigger and Acquire
- Math Function
- Display
- Help System

7.1 Measurement Configuration

Most measurement parameters are user-defined. Changing a measurement parameter will change the measurement precision and speed as well as the input impedance. An appropriate measurement parameter based on the actual application will ensure faster measurement or higher measurement precision.

The default measurement configurations of the multimeter can ensure the accuracy of the measurement results in most cases. Users can directly use these defaults for any measurement or modify the parameters of the measurement function as required.

Measurement parameters can be quickly set through the Function button on the front panel.

The parameters for different measurement function differ, see table below:

Table 7-1 Measurement parameter

Functions	Parameters
DCV	Range, Aperture, DC impedance, Auto Zero
ACV	Range, AC filter
DCI	Range, Aperture, Auto Zero
ACI	Range, AC filter
Ω 2W	Range, Aperture, Auto Zero
Ω 4W	Range, Aperture, Auto Zero
Cap	Range
Cont	Short-circuit resistance
Diode	Threshold voltage
Freq/Preiod	Range, Gate time
Temp	N/A
Sensor	Only support DCI, DCV, 2WR, 4WR measurement functions

7.1.1 Range

SDM4065A provides auto and manual range selecting modes. In auto mode, the multimeter selects a proper range automatically according to the input signal; in manual mode, you can use the knob on front panel, or the menu buttons on the screen to set the range. The auto mode can bring a lot of convenience for users while the manual mode provides higher reading precision.

Set the range by the knob on the front panel

Rotate the knob to move the cursor to the desired range menu, and then press the knob to select the range.

Set the range by the menu buttons

After entering the corresponding measurement function, touch the **Range** menu to see the range setting options for this function, as shown in the following figure (taking DCV measurement as an example). Press the menu buttons corresponding to the range to achieve the corresponding range configuration.

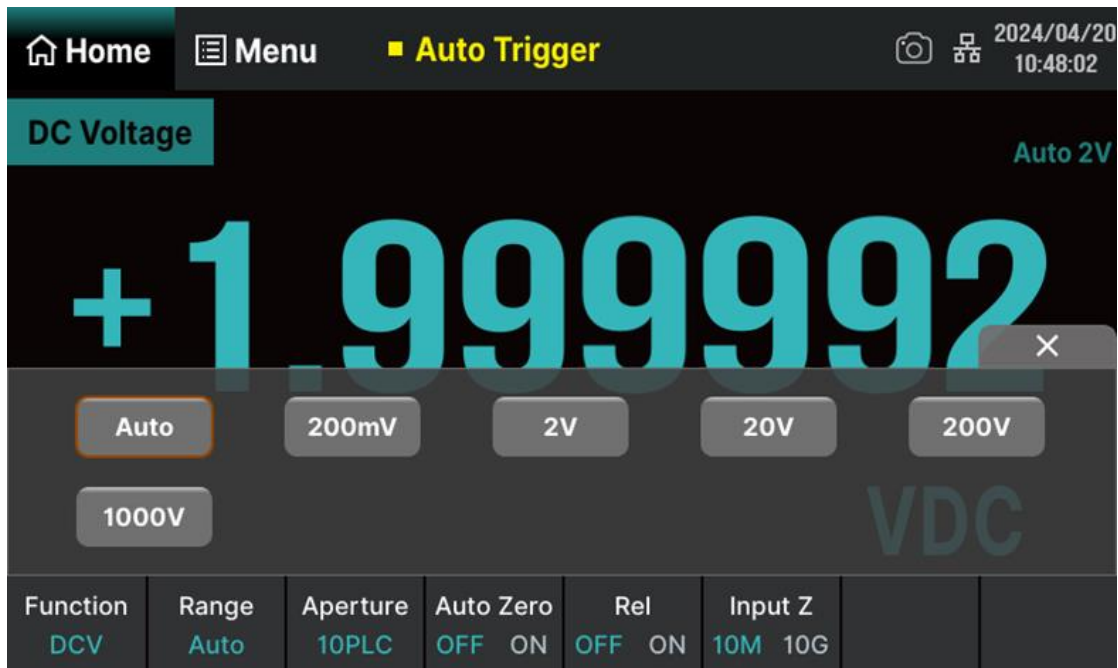

Figure 7-1 Range selection menu

Note:

1. "OVERLOAD" will be displayed when the input signal exceeds the current range.
2. After power on, remote reset, and startup with default factory settings, the range is set to Auto by default.
3. Auto mode is recommended if you are not sure about the measurement range in order to protect the instrument and obtain accurate data.
4. The range of CONT measurement is fixed at 2 K Ω .

7.1.2 Aperture

The aperture refers to the sampling period of the instrument's analog-to-digital converter on the input signal during the measurement period. The bigger the aperture is, the slower the measurement speed will be and the higher the resolution will be; the smaller the aperture is, the faster the measurement will be and the lower the resolution will be. The aperture applies to DCV, DCI, 2WR and 4WR measurements.

SDM4065A express the aperture by the power line cycles, the unit is PLC.

The multimeter will automatically detect the power frequency when starting up. When the frequency is 50Hz, the aperture can be set to 0.001 PLC, 0.01 PLC, 0.1 PLC, 1 PLC, 10 PLC, and 100 PLC. The default is 10 PLC.

When measuring DCV, DCI, 2WR and 4WR, select the **Aperture** in the menu to see the setting options, as shown in the following figure (taking DCV measurement as an example). Rotate the knob to move the cursor to the corresponding menu button, and then press the knob to achieve the corresponding configuration, or touch the desired menu buttons on the screen directly to set.

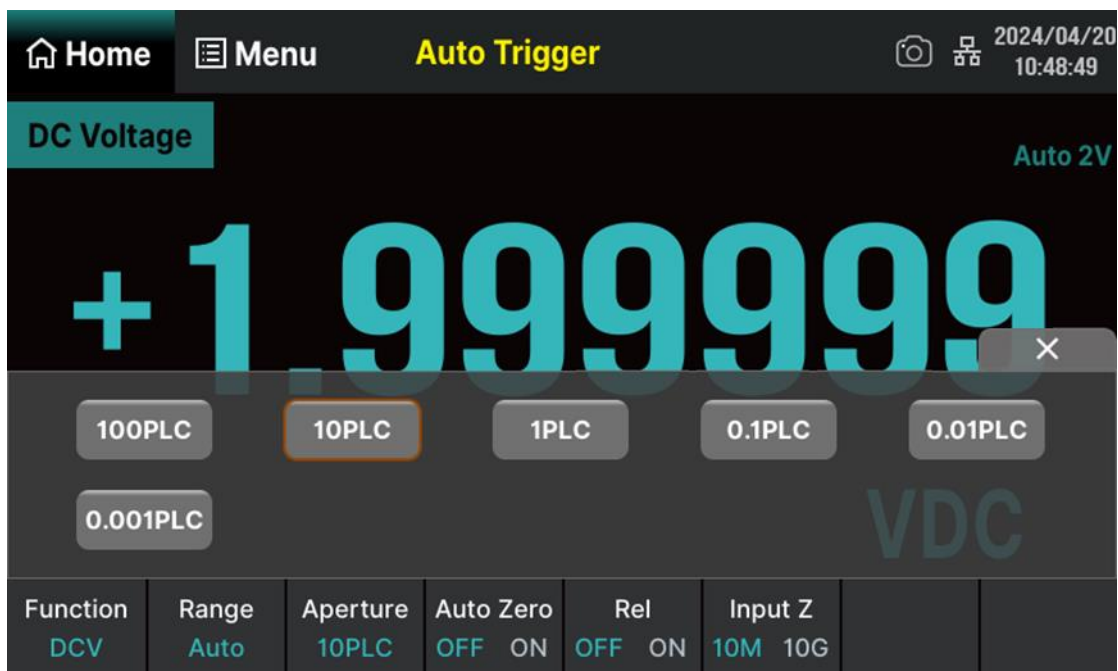

Figure 7-2 Aperture selection menu

7.1.3 DC Impedance

The DC impedance setting is applicable to the DCV measurement function, with a factory default value of "10 MΩ". In the range of 200 mV, 2 V or 20 V, you can choose "10 GΩ" to reduce the loading error to the measured object caused by the multimeter.

In the range of 200 mV, 2 V or 20 V under DCV measurement, touch **Input Z** in the menu to perform the setting, as shown in Figure 7-3.

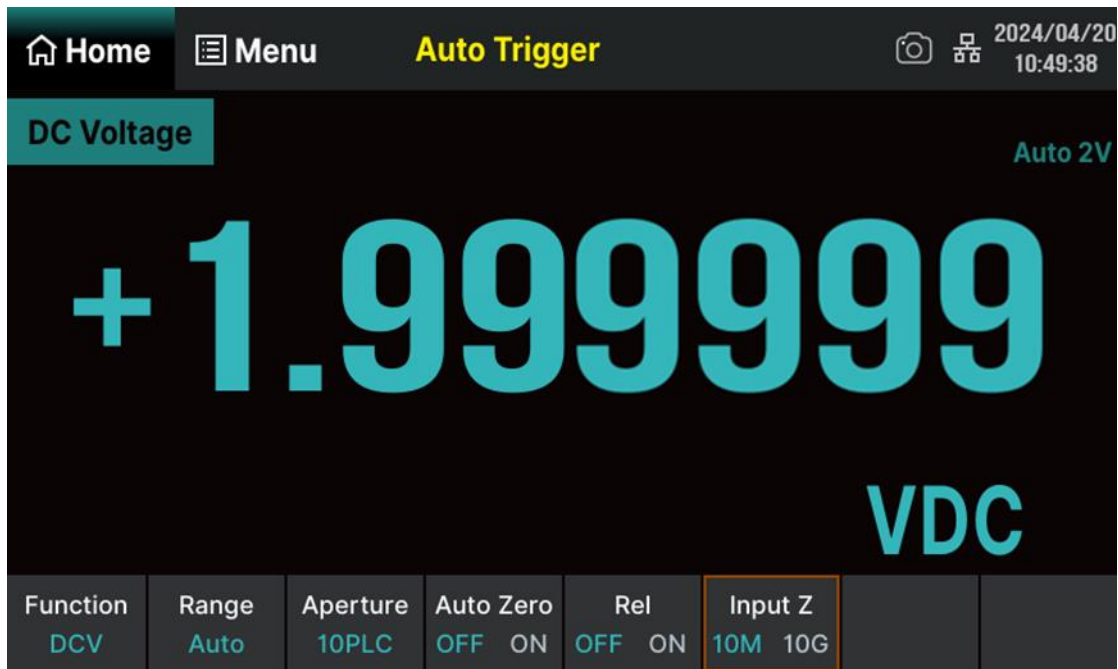

Figure 7-3 Choose DC input impedance

Touch the **Input Z** menu and select the input impedance value of 10 MΩ or 10 GΩ.

- 10 MΩ: Set the input impedances in all ranges to 10 MΩ.
- 10 GΩ: Set the input impedances in ranges of 200 mV, 2 V and 20 V to 10 GΩ, while in ranges of 200 V and 1000 V, the impedances are still 10 MΩ.

7.1.4 Auto Zero

Auto Zero applies to DCV, DCI, 2WR and 4WR measurements.

Enter the specific measurement function and touch **Auto Zero** in the menu to perform the setting, as shown in Figure 7-4 (taking DCV measurement as an example).

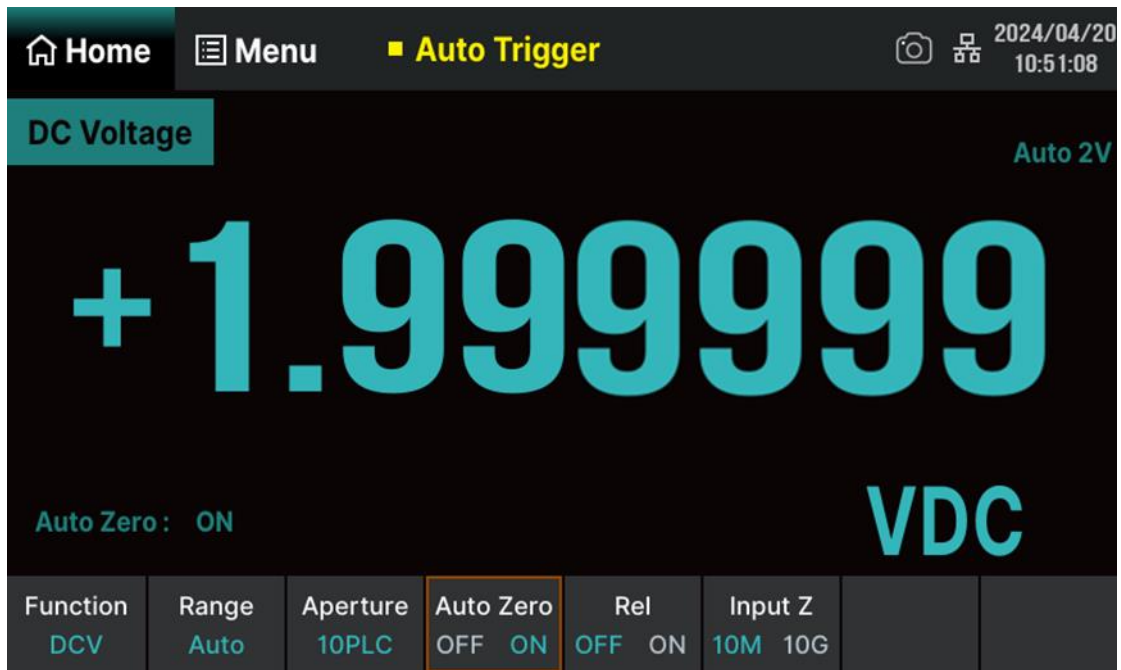

Figure 7-4 Set Auto Zero

- **When the state of "Auto Zero" is ON:**

The multimeter internally disconnects the input signal and measured circuit after each measurement, and takes a zero reading. It then subtracts the zero reading from the preceding reading (displaying the difference between the measurement value and zero value during the measurement), in order to reduce the impact of offset voltage from input circuit on measurement result.

- **When the state of "Auto Zero" is OFF:**

Disable the Auto Zero function.

7.1.5 AC Filter

AC filter applies to ACV and ACI measurements. It can optimize the low-frequency accuracy and minimize the AC settling time. SDM4065A provides three types of AC filters: >3Hz, >20Hz, >200Hz.

During the measurement process, the type of AC filter should be selected based on the frequency of the input signal. Normally, you should choose the highest frequency filter with a frequency less than the measured signal frequency, because higher frequency filters result in faster measurements. For example, when measuring signals in the range of 20 to 200 Hz, a 20 Hz filter is used. If measurement speed is not an issue, choosing a lower frequency filter will result in more stable measurements, depending on the signal that you are measuring.

Press **Filter** in the menu of ACV or ACI measurement interface to show the setting options, as shown in Figure 7-5 Set AC filter (taking ACV measurement as an example). Then press the menu operation key to activate the corresponding configuration.

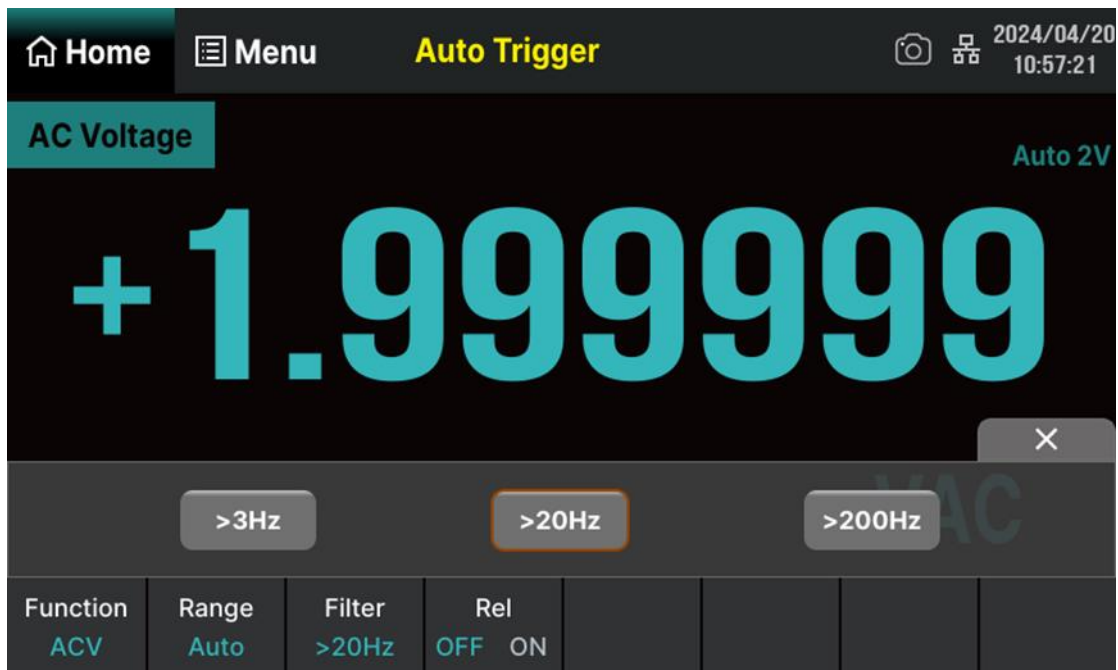

Figure 7-5 Set AC filter

7.1.6 Threshold Resistance

This function only applies to continuity measurement. When the measured circuit has a resistance lower than the threshold value, the circuit is considered as connected, and the buzzer sounds (if buzzer is on). The default short-circuit resistance is 50 Ω and the setting is stored in nonvolatile memory.

When continuity measurement function is enabled, touch on the **Threshold** menu, and touch the pop-up value box to set the desired value through the pop-up numeric keypad. The range can be set from 0 Ω to 2000 Ω , as shown in the Figure 7-6.

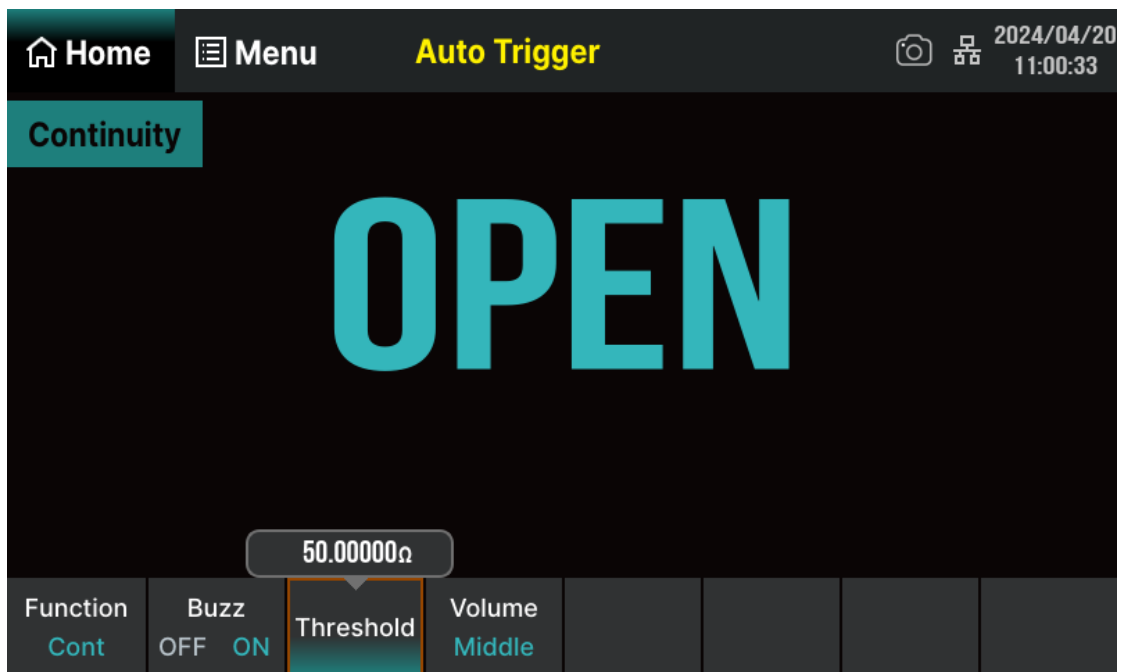

Figure 7-6 Set threshold resistance

7.1.7 Threshold Voltage

This function only applies to diode measurement. When the measured circuit has a threshold voltage value of the diode lower than the setting value, the buzzer sounds continuously (if buzzer is on). The default value of the threshold voltage is 2V and the setting is stored in nonvolatile memory.

When diode measurement function is enabled, touch the **Threshold** menu, and touch the pop-up value box to set the desired value through the pop-up numeric keypad. The range can be set from 0 V to 4 V, as shown in the Figure 7-7.

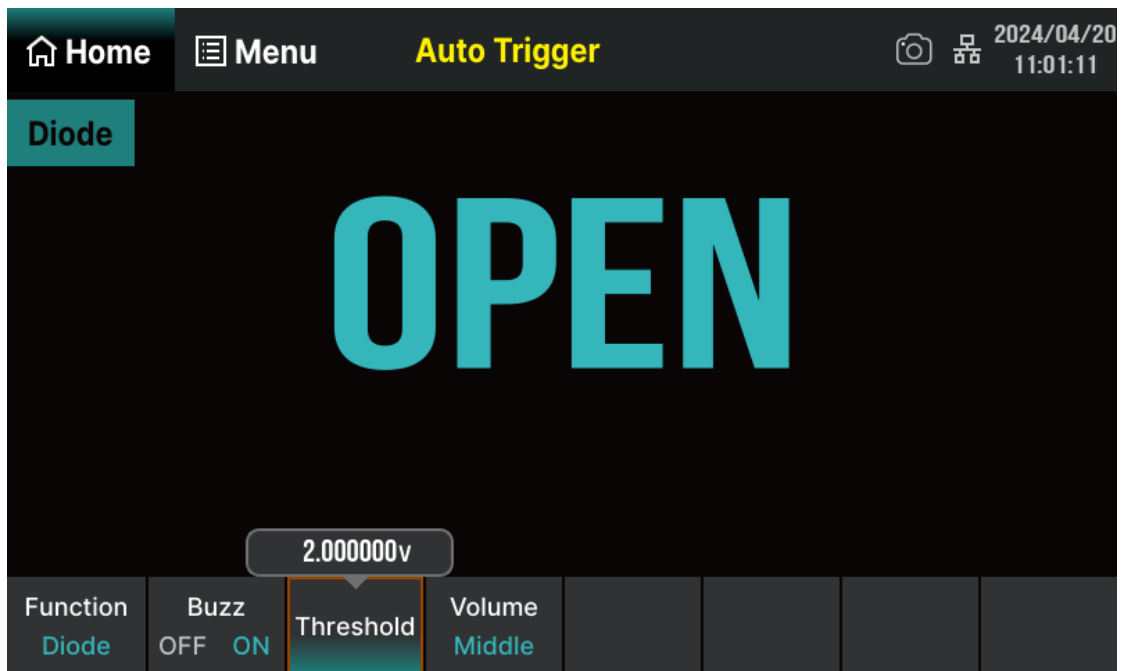

Figure 7-7 Set threshold voltage

7.1.8 Gate Time

This function applies to Freq/Period measurements. The length of gate time determines the resolution of low-frequency measurements. The longer the gate time, the higher the low-frequency measurement resolution and the lower the measurement rate; On the contrary, the lower the low-frequency measurement resolution, the higher the measurement rate.

In Freq/Period measurement, press **Gate Time** to show the setting options, as shown in Figure 7-8 (taking Freq measurement as an example). The gate time can be set to 1 ms, 10 ms, 100 ms or 1 s and the default is 100 ms. You can select a desired gate time by touching the corresponding menu.

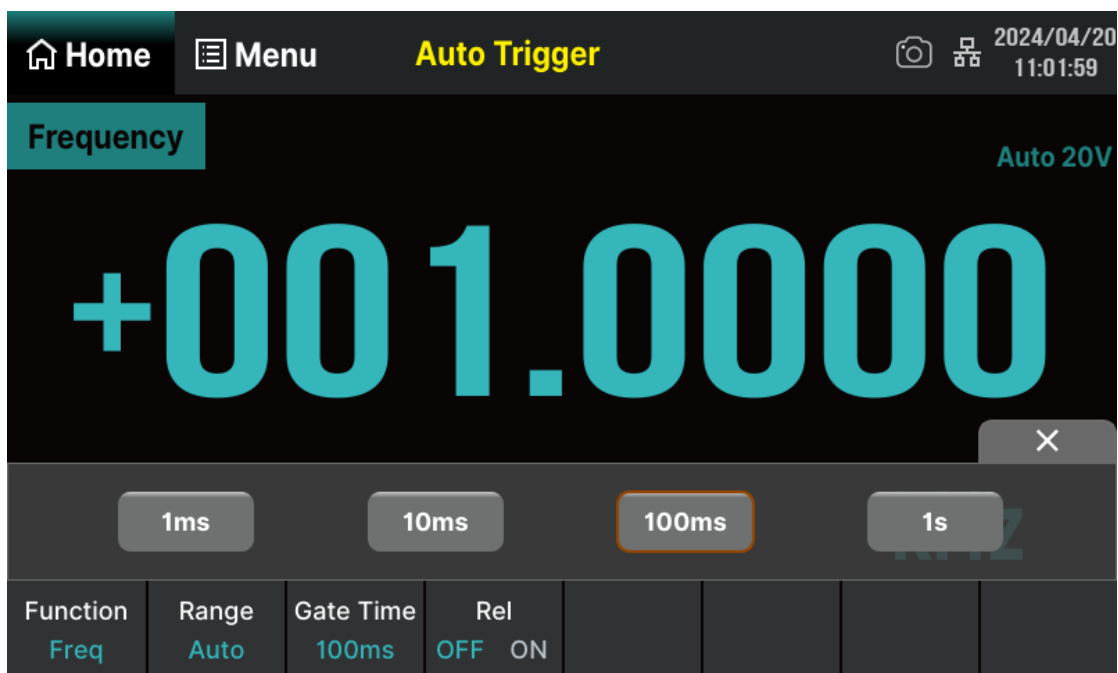

Figure 7-8 Set gate time

7.2 Basic Measurement Functions

SDM4065A Digital Multimeters have following basic functions:

- To Measure DC Voltage
- To Measure AC Voltage
- To Measure DC Current
- To Measure AC Current
- To Measure Resistance
- To Measure Capacitance
- To Measure Frequency and Period
- To Measure Continuity
- To Measure Diode
- To Measure Temperature
- User-defined Sensor Measurement
- Scanner Card

7.2.1 To Measure DC Voltage

Range: 200 mV, 2 V, 20 V, 200 V, 1000 V.

Max Resolution: 100 nV (in the range of 200 mV).

Input Protection: A 1000 V protection is available in all ranges and a 10% overrange for all ranges except 1000 V range. If the reading exceeds the range, “OVERLOAD” will be displayed.

Operating Steps:

1. Enable the DCV measurement

Press the **Function** button on the front panel and then touch the **DCV** menu item on the screen, or touch **Home** > **Function** > **DCV** on the screen to enter the DC voltage measurement interface, as shown in the following figure.

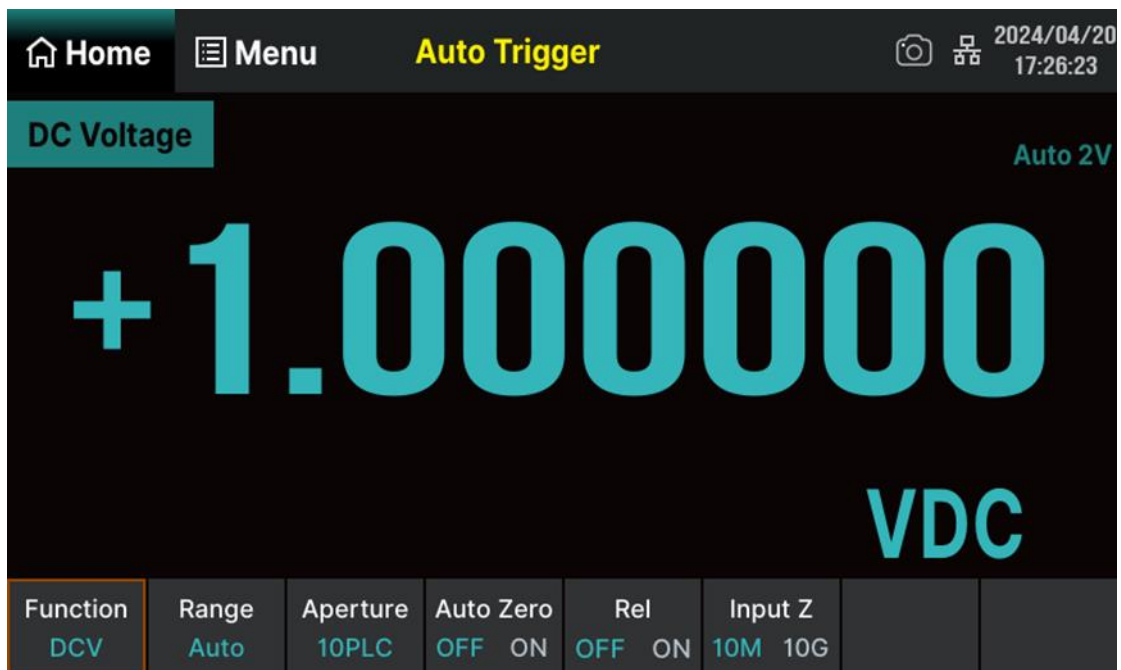

Figure 7-9 DC voltage measurement interface

2. Make connection

Connect the test leads with the measured signal by referring to “Measurement Connections”.

3. Set the range

Touch **Range** on the screen to enter the range setting interface. You can use the knob on the front panel, or the menu buttons on the screen to set the range. Auto (auto range) automatically selects the range for measurement based on input. Compared to the manual range, auto range is more convenient, but it can lead to slower measurement. The auto range adjustment can be adjusted up

to 110% of the current range and down to below 10% of the current range.

4. Set the aperture

Touch **Aperture** to select an aperture for measurement. Selecting 100 PLC provides the best noise rejection and resolution, but the slowest measurement speed.

5. Auto zero setting

Touch **Auto Zero** on the screen to enable or disable this function. Auto Zero provides the most accurate measurements, but requires additional time to perform the zero measurement. With Auto Zero enabled (ON), the multimeter internally measures the offset following each measurement. It then subtracts that measurement from the preceding reading. This prevents offset voltages present on the DMM's input circuitry from affecting measurement accuracy.

6. Specify the DC input impedance (Only for the ranges of 200 mV, 2 V and 20 V)

Touch **Input Z** to set the DC input impedance value. The default value of DC input impedance is 10 M Ω , which is already set at the factory. If you do not need to modify this parameter, you can proceed to the next step directly.

7. Set the relative value (optional operation)

Touch **Rel** to enable or disable relative math function. When the function is enabled, the reading displayed is a value which comes from the result of actual measurement value subtracts the relative value that has been set. The default relative value is the measurement value when the function is enabled. (Please refer to "Math Function" to know about the details.)

8. Read the measurement value

The multimeter measures the input signal according to the current measurement settings and displays the measurement result on the screen.

9. Make math operation (advanced operation)

You can perform math operation (Statistics, Limits, dBm, dB and Rel) on every DCV measurement reading. For details, please refer to "Math Function".

10. Display the graph (advanced operation)

You can analyze the measurement data by using Bar, Trend or Histogram display. For details, please refer to "Display".

7.2.2 To Measure AC Voltage

Range: 200 mV, 2 V, 20 V, 200 V, 750 V.

Max Resolution: 100 nV (in the range of 200 mV).

Input Protection: A 750 V protection is available in all ranges and a 10% overrange for all ranges except 750 V range. If the reading exceeds the range, "OVERLOAD" will be displayed.

Operating Steps:

1. Enable the ACV measurement

Press the **Function** button on the front panel and then touch the **ACV** menu item on the screen, or touch **Home** > **Function** > **ACV** on the screen to enter the AC voltage measurement interface, as shown in the following figure.

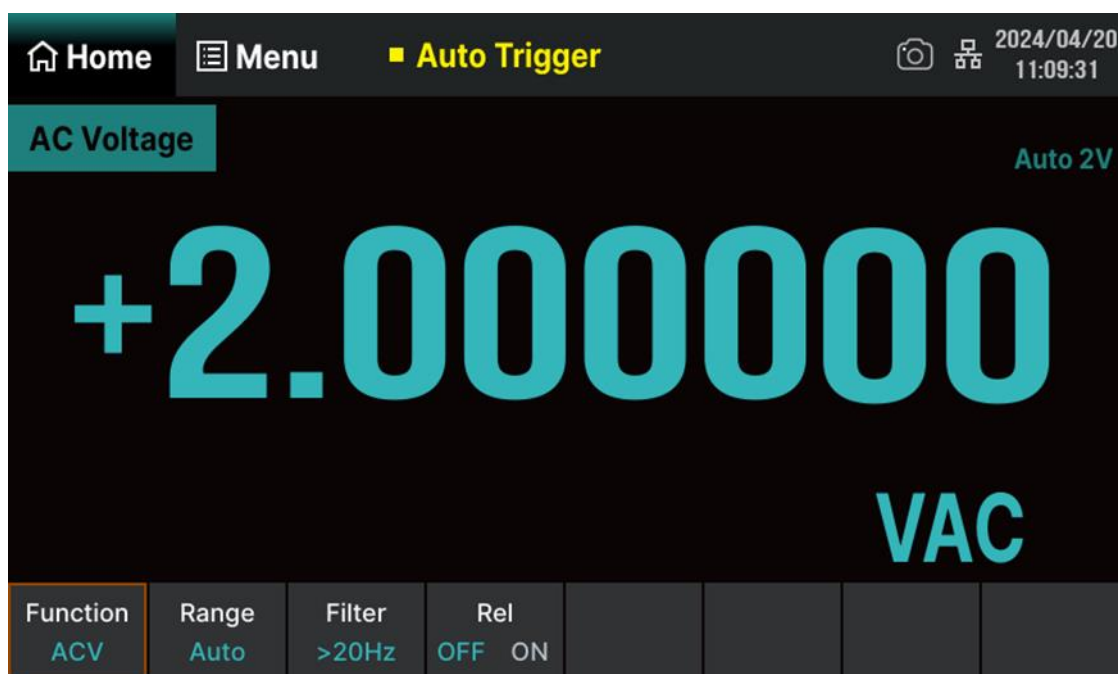

Figure 7-10 AC voltage measurement interface

2. Make connection

Connect the test leads with the measured signal by referring to "Measurement Connections".

3. Set the range

Touch **Range** on the screen to enter the range setting interface. You can use the knob on the front panel, or the menu buttons on the screen to set the range. Auto (auto range) automatically selects the range for measurement based on input. Compared to the manual range, auto range is more convenient, but it can lead to slower measurement. The auto range adjustment can be adjusted up

to 110% of the current range and down to below 10% of the current range.

4. Set the filter

Touch **Filter** and select the filter for the measurement. The instrument provides three different AC filters: >3 Hz, >20 Hz and >200 Hz, you should generally select the highest frequency filter whose frequency is less than that of the signal you are measuring.

5. Set the relative value (optional operation)

Touch **Rel** to enable or disable relative math function. When the function is enabled, the reading displayed is a value which comes from the result of actual measurement value subtracts the relative value that has been set. The default relative value is the measurement value when the function is enabled. (Please refer to “Math Function” to know about the details.)

6. Read the measurement value

The multimeter measures the input signal according to the current measurement settings and displays the measurement result on the screen.

7. Make math operation (advanced operation)

You can perform math operation (Statistics, Limits and Rel) on every ACV measurement reading. For details, please refer to “Math Function”.

8. Display the graph (advanced operation)

You can analyze the measurement data by using Bar, Trend or Histogram display. For details, please refer to “Display”.

7.2.3 To Measure DC Current

Range: 200 μ A, 2 mA, 20 mA, 200 mA, 2 A, 10 A.

Max Resolution: 0.1 nA (in the range of 200 μ A).

Input Protection: A 10 A protection is available in all ranges and a 10% overrange for all ranges except 10A range. If the reading exceeds the range, "OVERLOAD" will be displayed.

Operating Steps:

1. Enable the DCI measurement

Press the **Function** button on the front panel and then touch the **DCI** menu item on the screen, or touch **Home** > **Function** > **DCI** on the screen to enter the DC current measurement interface, as shown in the following figure.

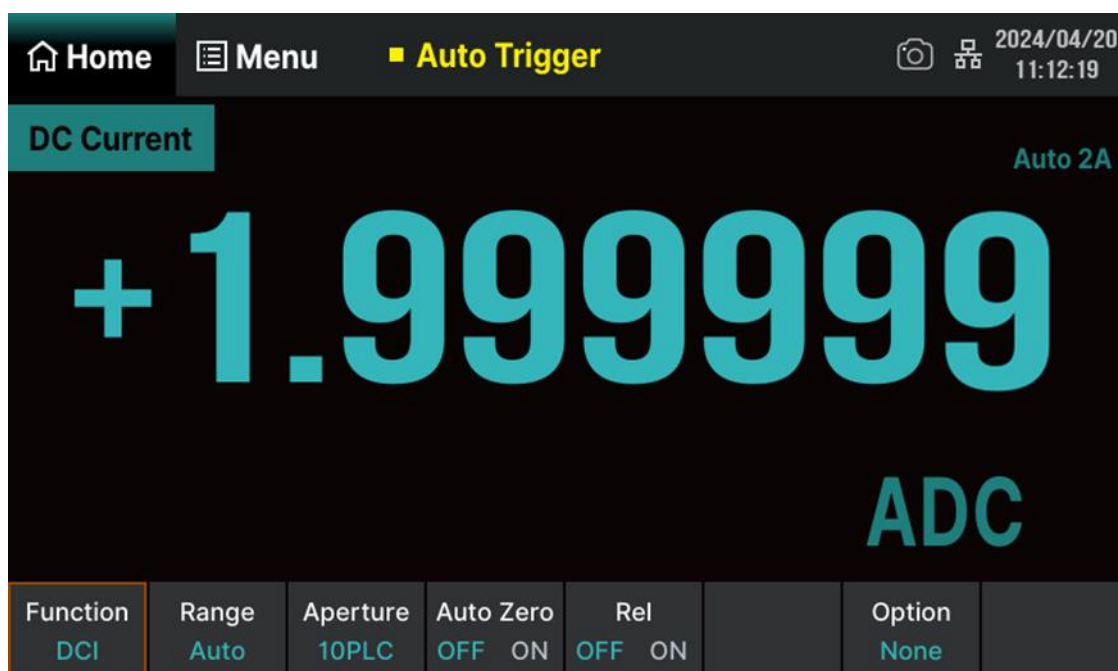

Figure 7-11 DC current measurement interface

2. Make connection

Connect the test leads with the measured signal by referring to "Measurement Connections".

3. Set the range

Touch **Range** on the screen to enter the range setting interface. You can use the knob on the front panel, or the menu buttons on the screen to set the range. Auto (auto range) automatically selects the range for measurement based on input. Compared to the manual range, auto range is more convenient, but it can lead to slower measurement. The auto range adjustment can be adjusted up

to 110% of the current range and down to below 10% of the current range.

4. Set the aperture

Touch **Aperture** to select an aperture for measurement. Selecting 100 PLC provides the best noise rejection and resolution, but the slowest measurement speed.

5. Auto zero setting

Touch **Auto Zero** on the screen to enable or disable this function. Auto Zero provides the most accurate measurements, but requires additional time to perform the zero measurement. With Auto Zero enabled (ON), the multimeter internally measures the offset following each measurement. It then subtracts that measurement from the preceding reading. This prevents offset voltages present on the DMM's input circuitry from affecting measurement accuracy.

6. Set the relative value (optional operation)

Touch **Rel** to enable or disable relative math function. When the function is enabled, the reading displayed is a value which comes from the result of actual measurement value subtracts the relative value that has been set. The default relative value is the measurement value when the function is enabled. (Please refer to "Math Function" to know about the details.)

7. Read the measurement value

The multimeter measures the input signal according to the current measurement settings and displays the measurement result on the screen.

8. Make math operation (advanced operation)

You can perform math operation (Statistics, Limits and Rel) on every DCI measurement reading. For details, please refer to "Math Function".

9. Display the graph (advanced operation)

You can analyze the measurement data by using Bar, Trend or Histogram display. For details, please refer to "Display".

7.2.4 To Measure AC Current

Range: 200 μ A, 2 mA, 20 mA, 200 mA, 2 A, 10 A.

Max Resolution: 0.1 nA (in the range of 200 μ A).

Input Protection: A 10 A protection is available in all ranges and a 10% overrange for all ranges except 10A range. If the reading exceeds the range, "OVERLOAD" will be displayed.

Operating Steps:

1. Enable the ACI measurement

Press the **Function** button on the front panel and then touch the **ACI** menu item on the screen, or touch **Home** > **Function** > **ACI** on the screen to enter the AC current measurement interface, as shown in the following figure.

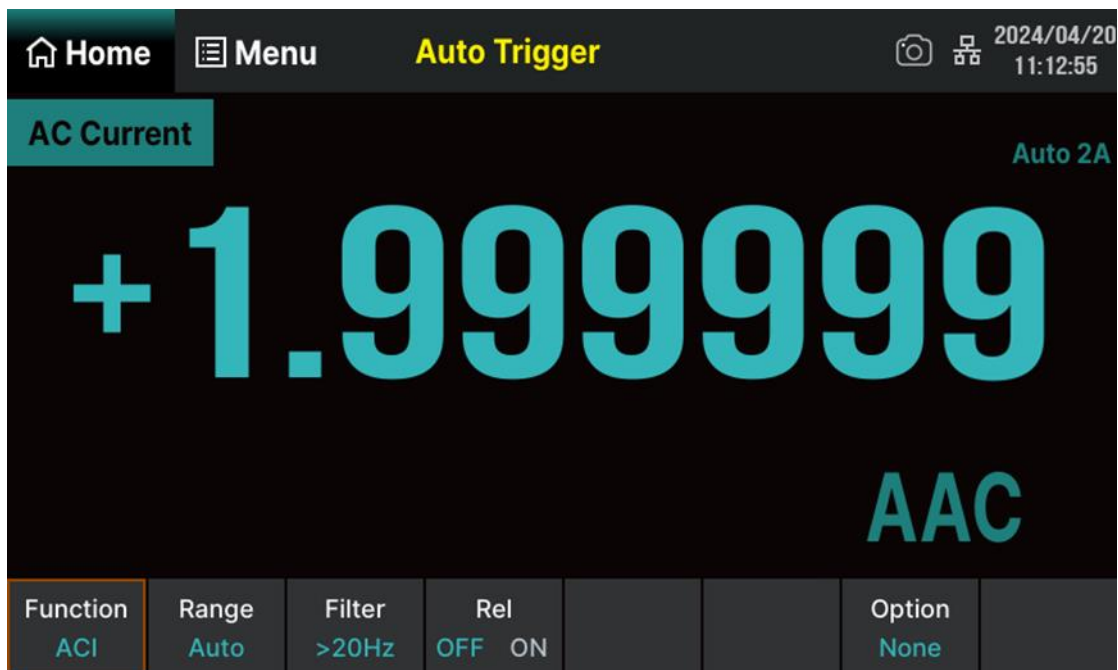

Figure 7-12 AC current measurement interface

2. Make connection

Connect the test leads with the measured signal by referring to "Measurement Connections".

3. Set the range

Touch **Range** on the screen to enter the range setting interface. You can use the knob on the front panel, or the menu buttons on the screen to set the range. Auto (auto range) automatically selects the range for measurement based on input. Compared to the manual range, auto range is more convenient, but it can lead to slower measurement. The auto range adjustment can be adjusted up

to 110% of the current range and down to below 10% of the current range.

4. Set the filter

Touch **Filter** and select the filter for the measurement. The instrument provides three different AC filters: >3 Hz, >20 Hz and >200 Hz, you should generally select the highest frequency filter whose frequency is less than that of the signal you are measuring.

5. Set the relative value (optional operation)

Touch **Rel** to enable or disable relative math function. When the function is enabled, the reading displayed is a value which comes from the result of actual measurement value subtracts the relative value that has been set. The default relative value is the measurement value when the function is enabled. (Please refer to “Math Function” to know about the details.)

6. Read the measurement value

The multimeter measures the input signal according to the current measurement settings and displays the measurement result on the screen.

7. Make math operation (advanced operation)

You can perform math operation (Statistics, Limits and Rel) on every ACI measurement reading. For details, please refer to “Math Function”.

8. Display the graph (advanced operation)

You can analyze the measurement data by using Bar, Trend or Histogram display. For details, please refer to “Display”.

7.2.5 To Measure Resistance

Range: 200 Ω , 2 k Ω , 20 k Ω , 200 k Ω , 1 M Ω , 10 M Ω , 100 M Ω .

Max Resolution: 100 $\mu\Omega$ (in the range of 200 Ω).

Input Protection: A 1000 V protection is available in all ranges and a 10% overrange for all ranges except 1000 V range. If the reading exceeds the range, “OVERLOAD” will be displayed.

SDM4065A provides 2-wire and 4-wire resistance measurements. When the measured resistance is lower than 100 k Ω , the 4-wire resistance measurement is recommended to reduce the measurement error caused by test lead resistance and contact resistance between the probe and the testing point because these two resistances cannot be ignored any more, compared to the measured resistance.

Operating Steps:

1. Enable 2-wire / 4-wire resistance measurement

Press the **Function** button on the front panel and then touch the **$\Omega 2W$** menu item on the screen, or touch **Home** > **Function** > **$\Omega 2W$** on the screen to enter the 2-wire resistance measurement interface, as shown in the following figure.

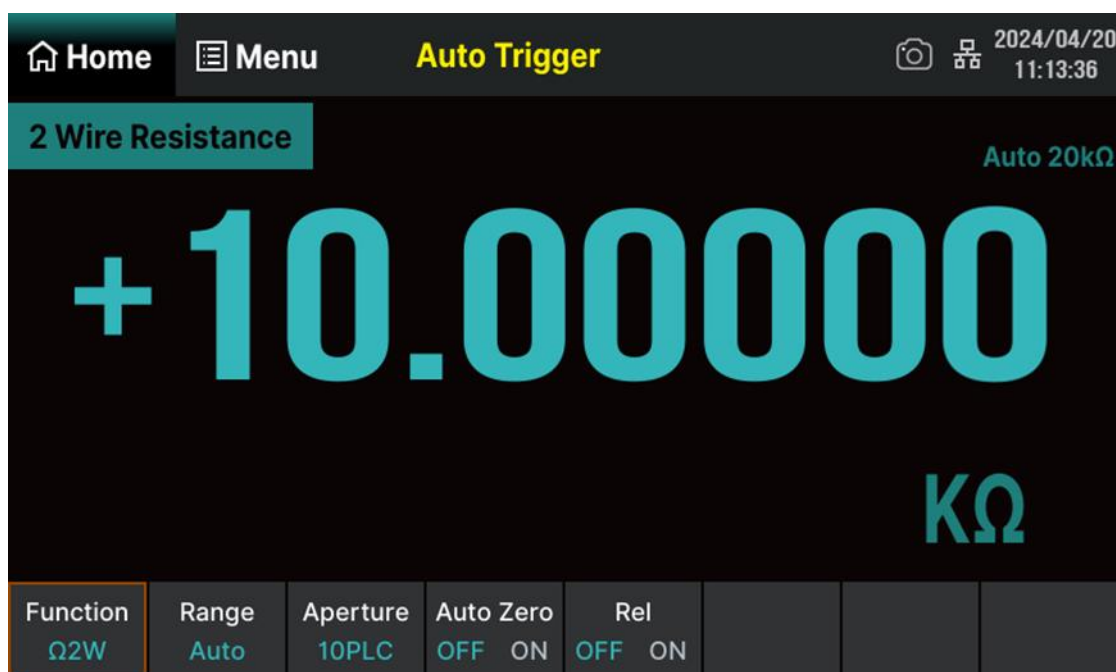

Figure 7-13 2-Wire resistance measurement interface

Press the **Function** button on the front panel and then touch the **$\Omega 4W$** menu item on the screen, or touch **Home** > **Function** > **$\Omega 4W$** on the screen to enter the 4-wire resistance

measurement interface, as shown in the following figure.

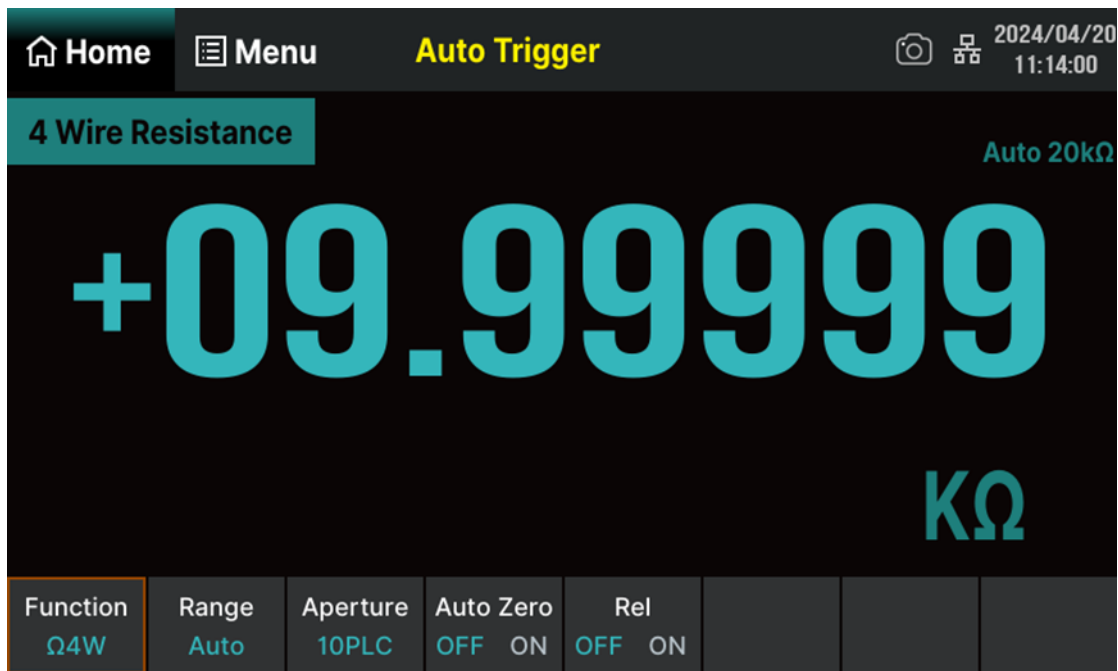

Figure 7-14 4-Wire resistance measurement interface

2. Make connection

Connect the test leads with the measured signal by referring to “Measurement Connections”.

3. Set the range

Touch **Range** on the screen to enter the range setting interface. You can use the knob on the front panel, or the menu buttons on the screen to set the range. Auto (auto range) automatically selects the range for measurement based on input. Compared to the manual range, auto range is more convenient, but it can lead to slower measurement. The auto range adjustment can be adjusted up to 110% of the current range and down to below 10% of the current range.

4. Set the aperture

Touch **Aperture** to select an aperture for measurement. Selecting 100 PLC provides the best noise rejection and resolution, but the slowest measurement speed.

5. Auto zero setting

Touch **Auto Zero** on the screen to enable or disable this function. Auto Zero provides the most accurate measurements, but requires additional time to perform the zero measurement. With Auto Zero enabled (ON), the multimeter internally measures the offset following each measurement. It then subtracts that measurement from the preceding reading. This prevents offset voltages present

on the DMM's input circuitry from affecting measurement accuracy.

6. Set the relative value (optional operation)

Touch **Rel** to enable or disable relative math function. When the function is enabled, the reading displayed is a value which comes from the result of actual measurement value subtracts the relative value that has been set. The default relative value is the measurement value when the function is enabled. (Please refer to "Math Function" to know about the details.)

7. Read the measurement value

The multimeter measures the input signal according to current measurement settings and displays the measurement result on the screen.

8. Make math operation (advanced operation)

You can perform math operation (Statistics, Limits and Rel) on every resistance measurement reading. For details, please refer to "Math Function".

9. Display the graph (advanced operation)

You can analyze the measurement data by using Bar, Trend or Histogram display. For details, please refer to "Display".



If the measured resistance is small, Rel operation is recommended in order to reduce the error caused by test lead.

Both ends of the measured resistance should be placed far away from your hands and desks that can conduct electricity; otherwise, the measurement result might be inaccurate. The greater the measured resistance is, the greater the affect will be.

7.2.6 To Measure Capacitance

Range: 2 nF, 20 nF, 200 nF, 2 μ F, 20 μ F, 200 μ F, 2 mF, 20 mF, 100 mF.

Max Resolution: 2 pF (in the range of 2 nF).

Input Protection: A 1000 V protection is available in all ranges and a 10% overrange for all ranges except 1000 V range. If the reading exceeds the range, “OVERLOAD” will be displayed.

Operating Steps:

1. Enable capacitance measurement

Press the **Function** button on the front panel and then touch the **-|+** on the screen, or touch **Home** > **Function** > **-|+** on the screen to enter the capacitance measurement interface, as shown in the following figure.

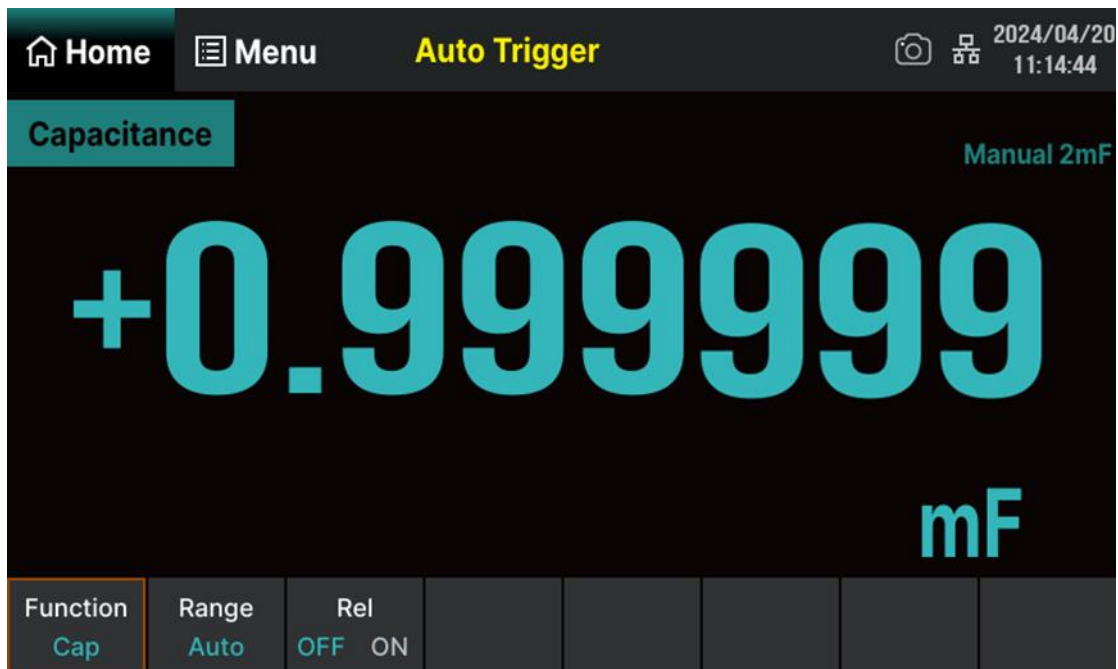

Figure 7-15 Capacitance measurement interface

2. Make connection

Connect the test leads with the measured signal by referring to “Measurement Connections”.

3. Set the range

Touch **Range** on the screen to enter the range setting interface. You can use the knob on the front panel, or the menu buttons on the screen to set the range. Auto (auto range) automatically selects the range for measurement based on input. Compared to the manual range, auto range is more convenient, but it can lead to slower measurement. The auto range adjustment can be adjusted up

to 110% of the current range and down to below 10% of the current range.

4. Set the relative value (optional operation)

Touch **Rel** to enable or disable relative math function. When the function is enabled, the reading displayed is a value which comes from the result of actual measurement value subtracts the relative value that has been set. The default relative value is the measurement value when the function is enabled. (Please refer to “Math Function” to know about the details.)

5. Read the measurement value

The multimeter measures the input signal according to the capacitance measurement settings and displays the measurement result on the screen.

6. Make math operation (advanced operation)

You can perform math operation (Statistics, Limits and Rel) on every capacitance measurement reading. For details, please refer to “Math Function”.

7. Display the graph (advanced operation)

You can analyze the measurement data by using Bar, Trend or Histogram display. For details, please refer to “Display”.



Please short contact the two feet of an electrolytic capacitor by using a test lead before measuring the electrolytic capacitor.

7.2.7 To Measure Frequency and Period

Frequency (Period) Range: From 3 Hz to 1 MHz (from 1 μ s to 0.33 s).

Input Signal Range: 200 mV, 2 V, 20 V, 200 V, 750 V.

Input Protection: A 750 V protection is available in all ranges.

Operating Steps:

1. Enable Freq/Period measurement

Press the **Function** button on the front panel and then touch the **Freq** on the screen, or touch **Home** > **Function** > **Freq** on the screen to enter the frequency measurement interface, as shown in the following figure.

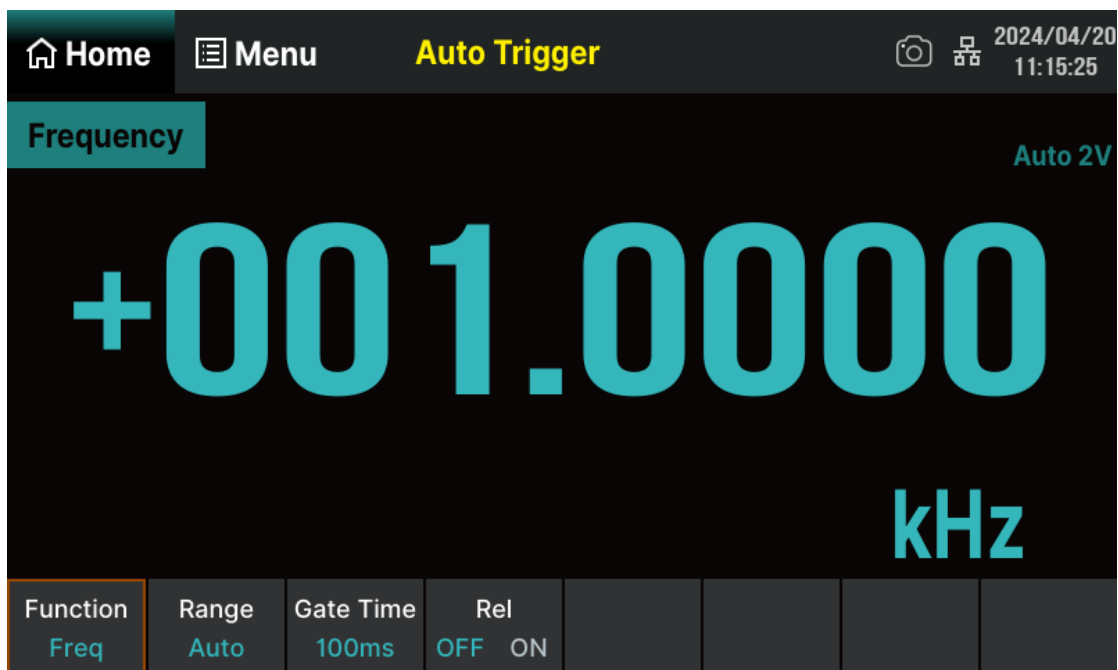

Figure 7-16 Frequency measurement interface

Press the **Function** button on the front panel and then touch the **Period** on the screen, or touch **Home** > **Function** > **Period** on the screen to enter the period measurement interface, as shown in the following figure.

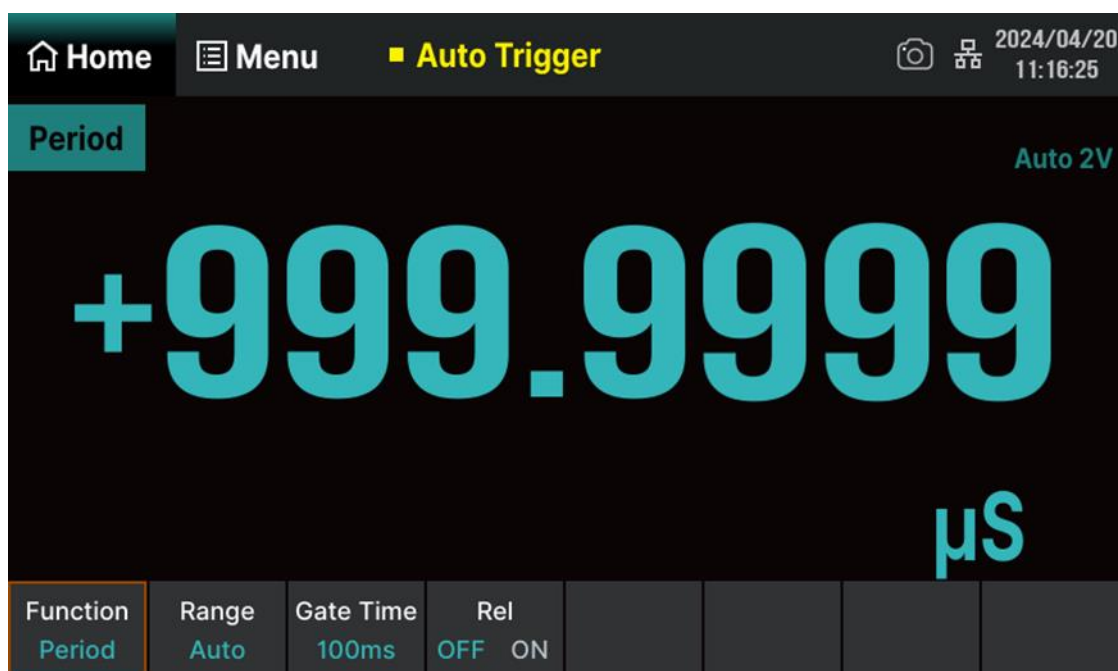

Figure 7-17 Period measurement interface

2. Make connection

Connect the test leads with the measured signal by referring to “Measurement Connections”.

3. Set the range

Touch **Range** on the screen to enter the range setting interface. You can use the knob on the front panel, or the menu buttons on the screen to set the range. Auto (auto range) automatically selects the range for measurement based on input. Compared to the manual range, auto range is more convenient, but it can lead to slower measurement. The auto range adjustment can be adjusted up to 110% of the current range and down to below 10% of the current range.

4. Set the gate time

Touch **Gate Time** and choose the measurement aperture of 1 ms, 10 ms, 100 ms (default), or 1 s.

5. Set the relative value (optional operation)

Touch **Rel** to enable or disable relative math function. When the function is enabled, the reading displayed is a value which comes from the result of actual measurement value subtracts the relative value that has been set. The default relative value is the measurement value when the function is enabled. (Please refer to “Math Function” to know about the details.)

6. Read the measurement value

The multimeter measures the input signal according to the current measurement settings and displays the measurement result on the screen.

7. Make math operation (advanced operation)

You can perform math operation (Statistics, Limits and Rel) on every frequency/period measurement reading. For details, please refer to “Math Function”.

8. Display the graph (advanced operation)

You can analyze the measurement data by using Bar, Trend or Histogram display. For details, please refer to “Display”.

7.2.8 To Measure Continuity

Test Current Source: 1 mA.

Max Resolution: 0.01 Ω .

Input Protection: 1000 V input protection.

Open-circuit Voltage: < 8 V.

Beep Threshold (short-circuit resistance): From 0 Ω to 2000 Ω .

This function measures the resistance of the tested circuit with a current of 1mA and determines whether the circuit is connected. When the measured resistance is lower than the short-circuit resistance (Threshold), the buzzer sounds continuously (if buzzer is on).

Operating Steps:

1. Enable continuity measurement

Press the **Function** button on the front panel and then touch the **Cont** on the screen, or touch **Home** > **Function** > **Cont** on the screen to enter the continuity measurement interface, as shown in the following figure.

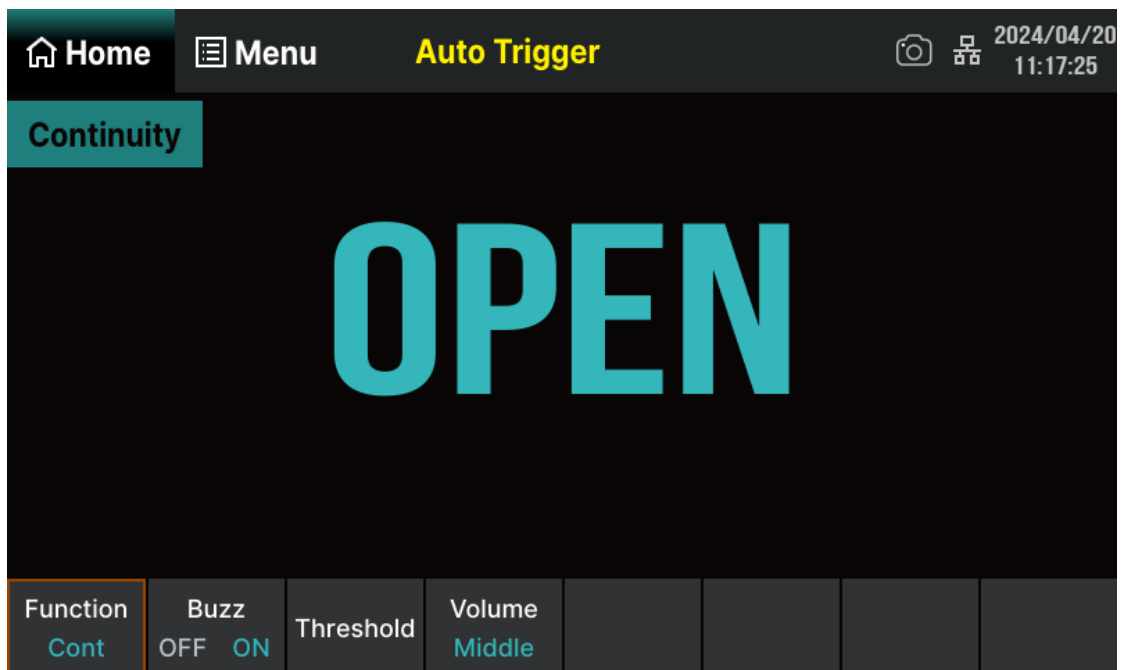

Figure 7-18 Continuity measurement interface

2. Make connection

Connect the test leads with the measured signal by referring to “Measurement Connections”.

3. Set the short-circuit resistance (Threshold)

Touch the **Threshold** on the screen menu and touch the pop-up value box to set the desired value through the pop-up numeric keypad. The range can be set to 0 to 2 k Ω , with a default value of 50 Ω . Touch **Buzz** > **ON/OFF** to turn on or off the buzzer function. When the buzzer is turned on, if the input signal is below the threshold, the instrument will continue to emit a buzz.

4. Read the measurement value

The multimeter measures the input signal according to the current measurement settings and displays the measurement result on the screen.

5. Make math operation (advanced operation)

You can perform math operation (Statistics, Limits) on every continuity measurement reading. For details, please refer to “Math Function”.

6. Display the graph (advanced operation)

You can analyze the measurement data by using Bar, Trend or Histogram display. For details, please refer to “Display”.



Before testing continuity, please cut off the power and discharge all the high-voltage containers to avoid damages to the Multimeter.

7.2.9 To Measure Diode

Test Current Source: 1 mA.

Voltage Measurement Range: 0 V~4 V.

Max Resolution: 10 μ V.

Input Protection: 1000 V input protection.

Open-circuit Voltage: <8 V.

This function measures the forward voltage drop on the diode. When the voltage is lower than Threshold, the buzzer sounds (if the buzzer is on).

Operating Steps:

1. Enable diode measurement

Press the **Function** button on the front panel and then touch the **->+** on the screen, or touch **Home** > **Function** > **->+** to enter the diode measurement interface, as shown in the following figure.

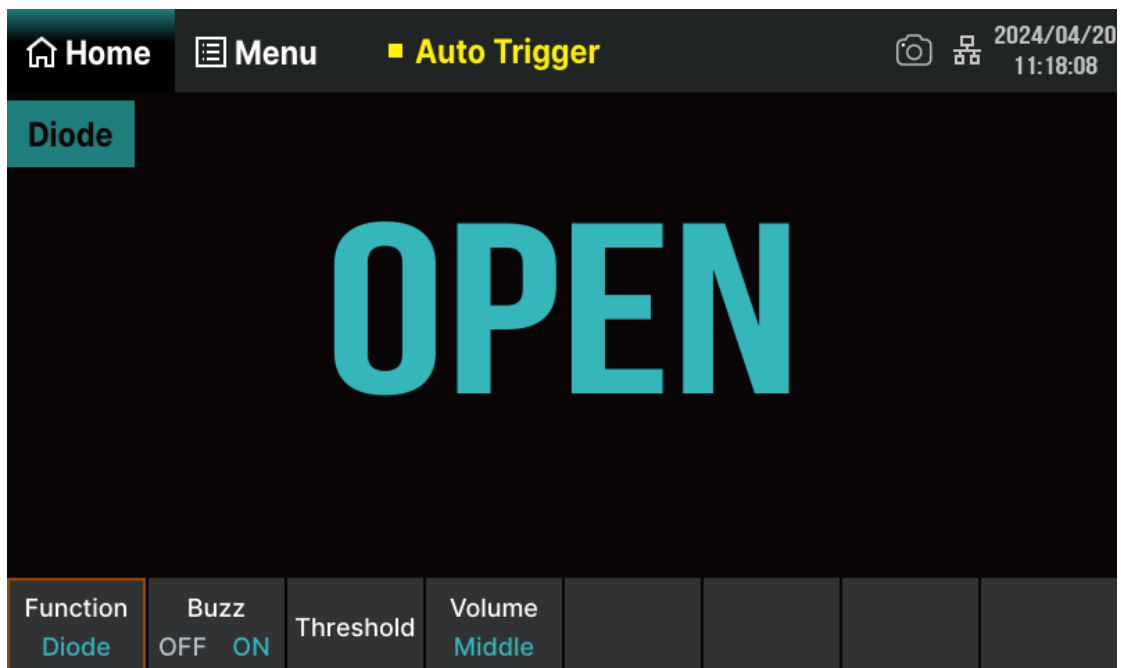

Figure 7-19 Diode measurement interface

2. Make connection

Connect the test leads with the measured signal by referring to “Measurement Connections”.

3. Set the Threshold

Touch the **Threshold** on the screen menu and enter the desired value (threshold) in the pop-up menu. The range can be set to 0 to 4V, with a default value of 2V.

4. Read the measurement value

The multimeter screen displays the measured voltage value when the diode is connected; otherwise, the screen displays "OPEN".

5. Evaluate the results of measurement

Reverse the probes and measure the forward voltage drop on the diode again. Evaluate the diode according to the following rules:

- If the Multimeter displays "OPEN" when in reverse bias model, it indicates that the diode is normal.
- If the Multimeter shows voltage about 0V and the instrument beeps persistently when in forward and reverse bias model, it indicates that the diode is short.
- If the Multimeter shows "OPEN" when in forward and reverse model, it indicates that the diode is open.

6. Make math operation (advanced operation)

You can perform math operation (Statistics, Limits) on every diode measurement reading. For details, please refer to "Math Function".

7. Display the graph (advanced operation)

You can analyze the measurement data by using Bar, Trend or Histogram display. For details, please refer to "Display".



Before testing diode, please cut off the power and discharge all the high-voltage containers to avoid damages to the multimeter.

7.2.10 To Measure Temperature

The SDM4065A multimeter supports two types of temperature sensor measurements: RTD and thermocouple sensors.

Operating Steps:

1. Enable temperature measurement

Press the **Function** button on the front panel and then touch the **Temp** on the screen, or touch **Home** > **Function** > **Temp** on the screen to enter the temperature measurement interface, as shown in the following figure.

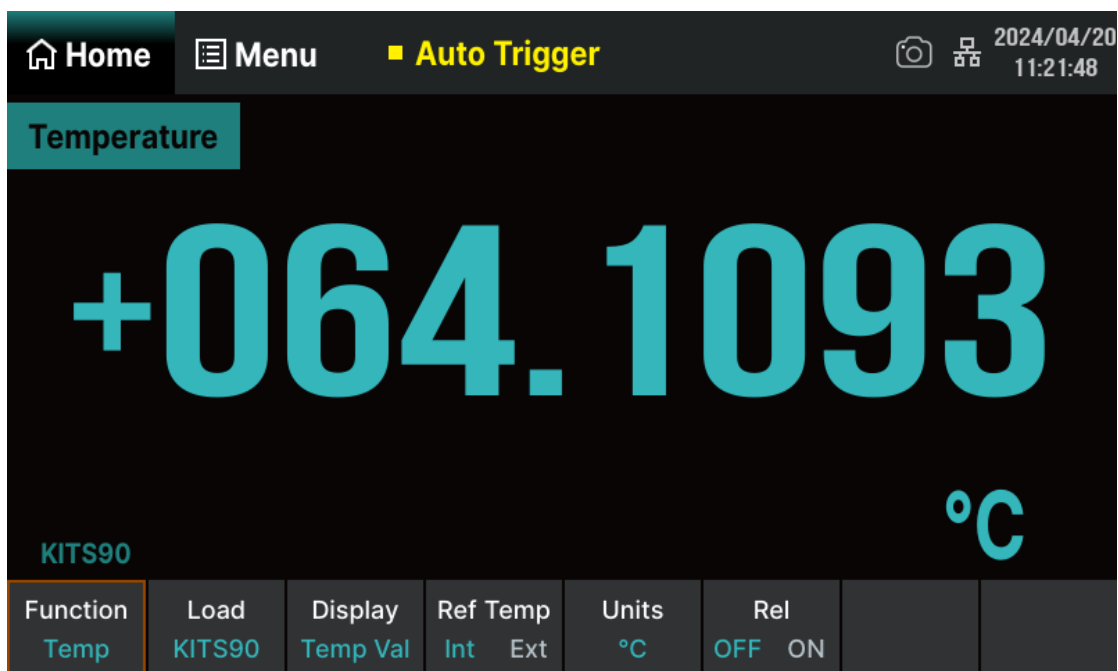

Figure 7-20 Temperature measurement interface

2. Make connection

Connect the test leads with the measured signal by referring to “Measurement Connections”.

3. Set the type of sensor

Touch the **Load** on the screen menu and select the corresponding sensor type based on the connected test object., as shown in the following figure.

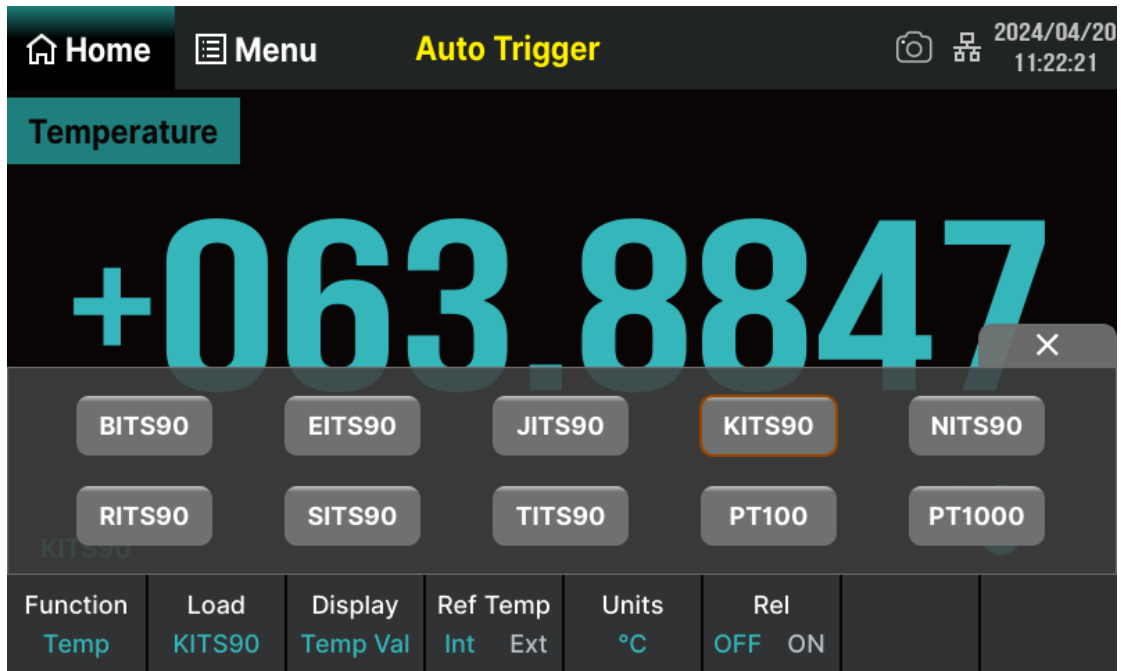

Figure 7-21 Sensor type selection interface

4. Select the Display Mode

Touch the **Display** on the screen menu to select the display mode. The SDM4065A multimeter supports two display modes: **Temp** and **All**. The screen only displays temperature values if **Temp** is selected; The screen displays both the temperature value (main display) and the actual measured value (secondary display) if **All** is selected.

5. Set the Reference Temperature

Touch the **Ref Temp** on the screen menu to set the reference temperature to be in the internal/external state. When selecting an external state, reference values can be set on the numeric keypad interface. The default reference value is 0.

6. Select temperature unit

Touch the **Units** on the screen menu to select the unit for temperature measurement. SDM4065A supports three units: °C, °F, and K. As shown in the following figure.

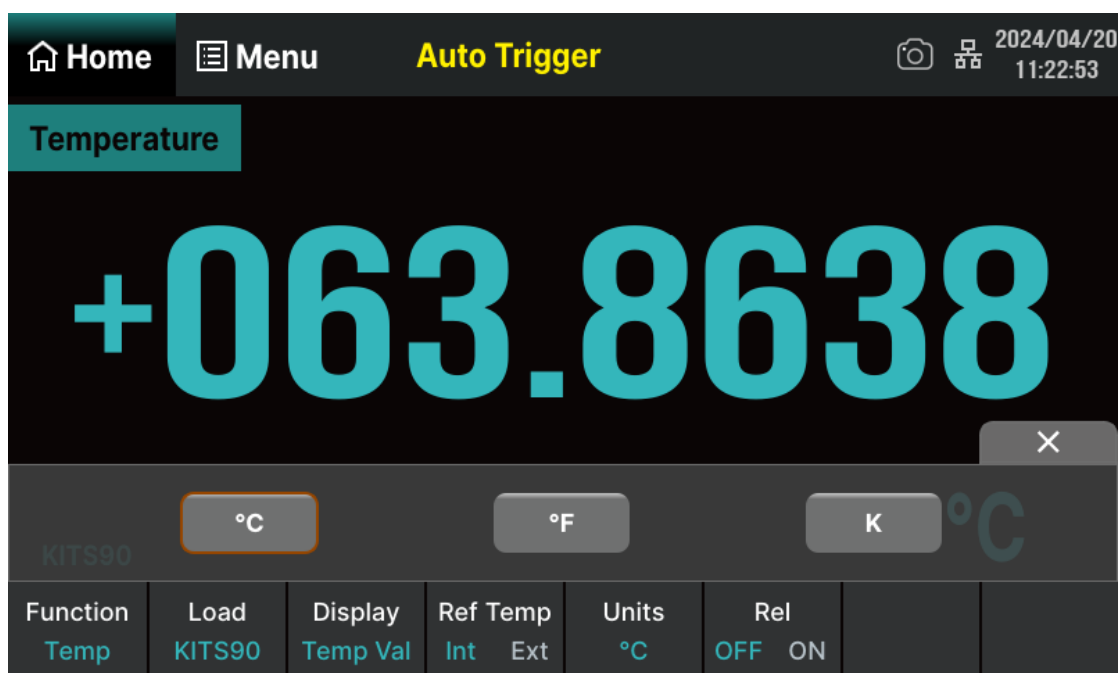

Figure 7-22 Temperature unit selection interface

7. Set the relative value (optional operation)

Touch **Rel** to enable or disable relative math function. When the function is enabled, the reading displayed is a value which comes from the result of actual measurement value subtracts the relative value that has been set. The default relative value is the measurement value when the function is enabled. (Please refer to “Math Function” to know about the details.)

8. Read the measurement value

The multimeter measures the input signal according to the current measurement settings and displays the measurement result on the screen.

9. Make math operation (advanced operation)

You can perform math operation (Statistics, Limits and Rel) on every measurement reading. For details, please refer to “Math Function”.

10. Display the graph (advanced operation)

You can analyze the measurement data by using Bar, Trend or Histogram display. For details, please refer to “Display”.

7.2.11 User-defined Sensor Measurement

The sensor measurement function can convert the measured physical quantities (pressure, flow rate, temperature, etc.) into easily measurable physical quantities such as voltage, current, resistance, etc. for measurement. Users only need to input the response curve in advance, and the multimeter will use internal algorithms for numerical conversion and correction, ultimately displaying the measured physical quantity on the screen. You can freely edit and modify the display unit of the measured physical quantity.

SDM4065A supports user-defined (DCV, DCI, 2WR, 4WR) sensor measurement.

Operating Steps:

1. Enable Sensor measurement

Press the **Function** button on the front panel and then touch the **Sensor** on the screen, or touch **Home** > **Function** > **Sensor** on the screen to enter the sensor measurement interface, as shown in the following figure.

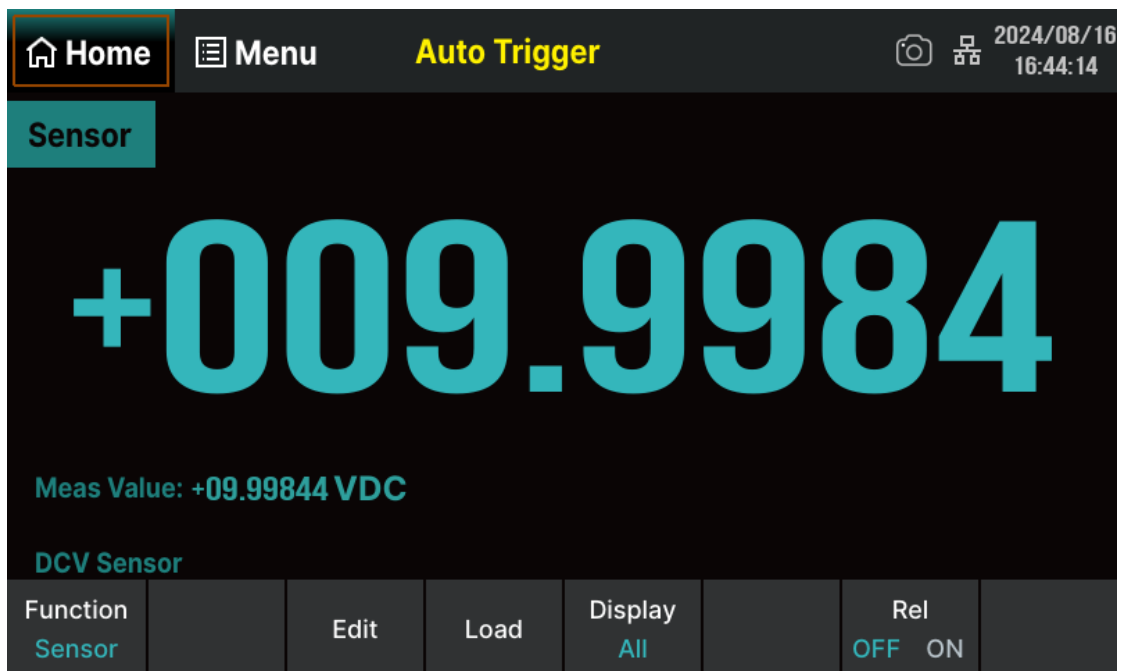

Figure 7-23 Sensor measurement interface

2. Make connection

Connect the test leads with the measured signal by referring to “Measurement Connections”.

3. Edit configuration file

Touch the **Edit** on the screen menu to enter the modification interface of the configuration file options, which allows you to modify the currently opened or stored sensor configuration file.

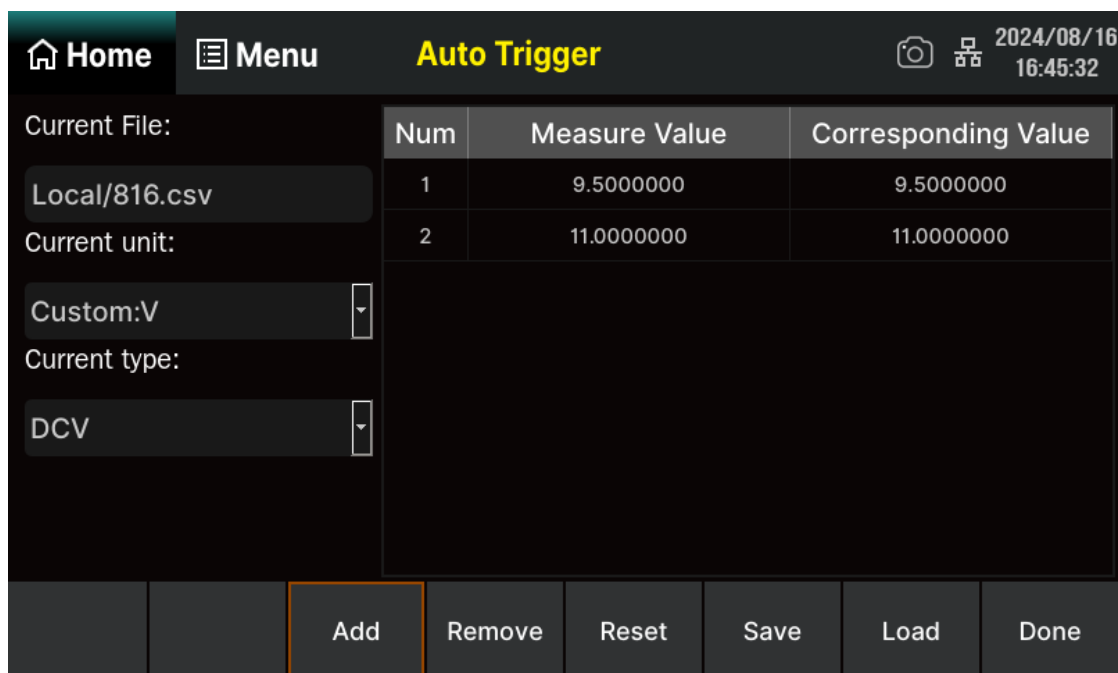

Figure 7-24 Modification interface for configuration file options

4. Load configuration file

Touch the **Load** on the screen menu to load the internal non-volatile storage space or sensor configuration files already stored in the USB drive. Please refer to the instructions in "Store/Recall" for details.

5. Select the Display Mode

Touch the **Display** on the screen menu to select the display mode. The SDM4065A multimeter supports two display modes: **Sensor Val** and **All**. The screen only displays temperature values if **Sensor Val** is selected; The screen displays both the corresponding value (main display) and the measured value (secondary display) if **All** is selected. The corresponding value refers to the actual value of the measured physical quantity.

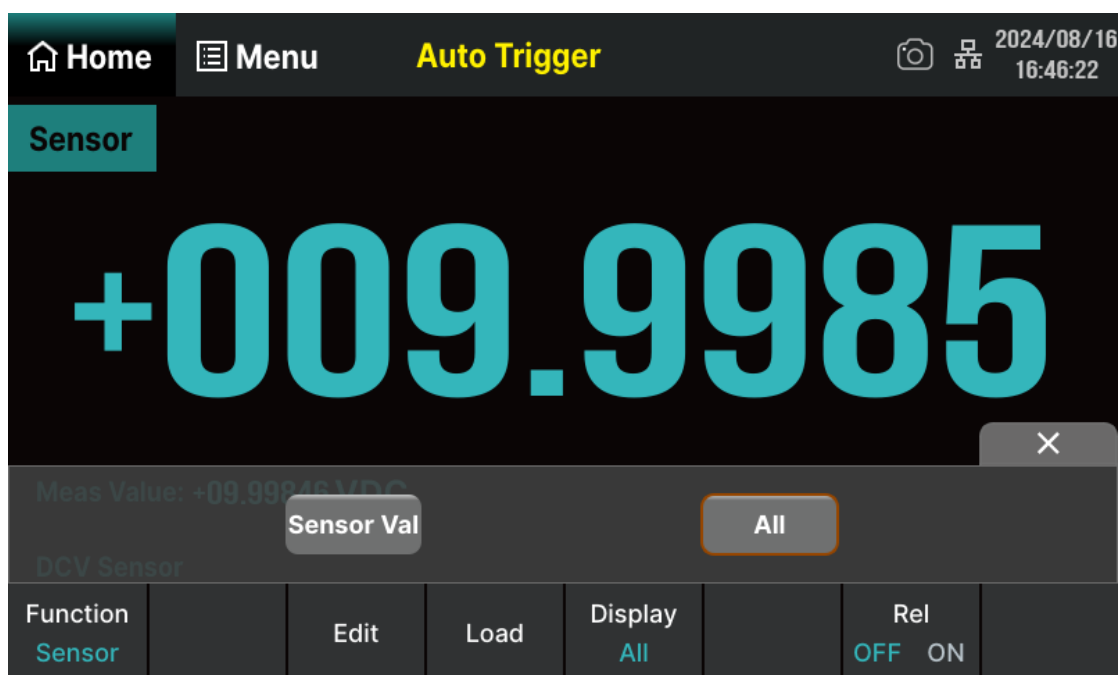

6. Set the relative value (optional operation)

Touch **Rel** to enable or disable relative math function. When the function is enabled, the reading displayed is a value which comes from the result of actual measurement value subtracts the relative value that has been set. The default relative value is the measurement value when the function is enabled. (Please refer to “Math Function” to know about the details.)

7.2.12 Scanner Card

After installing the scanner card according to "Scanner Card" chapter, press the **Function** button on the front panel of the multimeter, and then touch the **Scanner** on the screen to enter the Scanner Card function interface, as shown in the following figure:

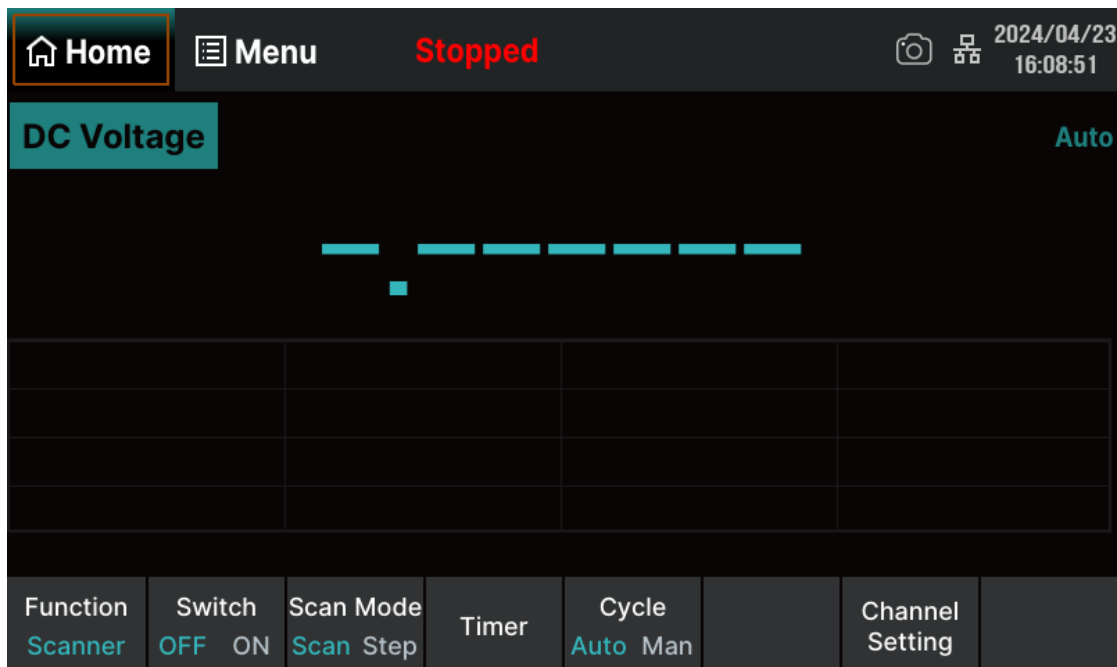

Figure 7-25 Scanner function interface

Table 7-2 Scanner function menu description

Function Menu	Setting	Description
Switch	OFF/ON	Switch on or off the scanner function.
Scan Mode	Scan/Step	Set scan mode to Scan or Step.
Timer	0 ms~999.999 s	Set the time interval between each scan (scan mode) or between each channel (step mode).
Cycle	Auto/Man	Set the number of scan cycles automatically or manually.
Channel Setting		Set the measurement function, range, scan speed, and other parameters for the specified channel.

Operation Steps

1. Switch on the scanner function

Touch **Switch** > **ON** to enable the scanner function, as shown in the following figure:

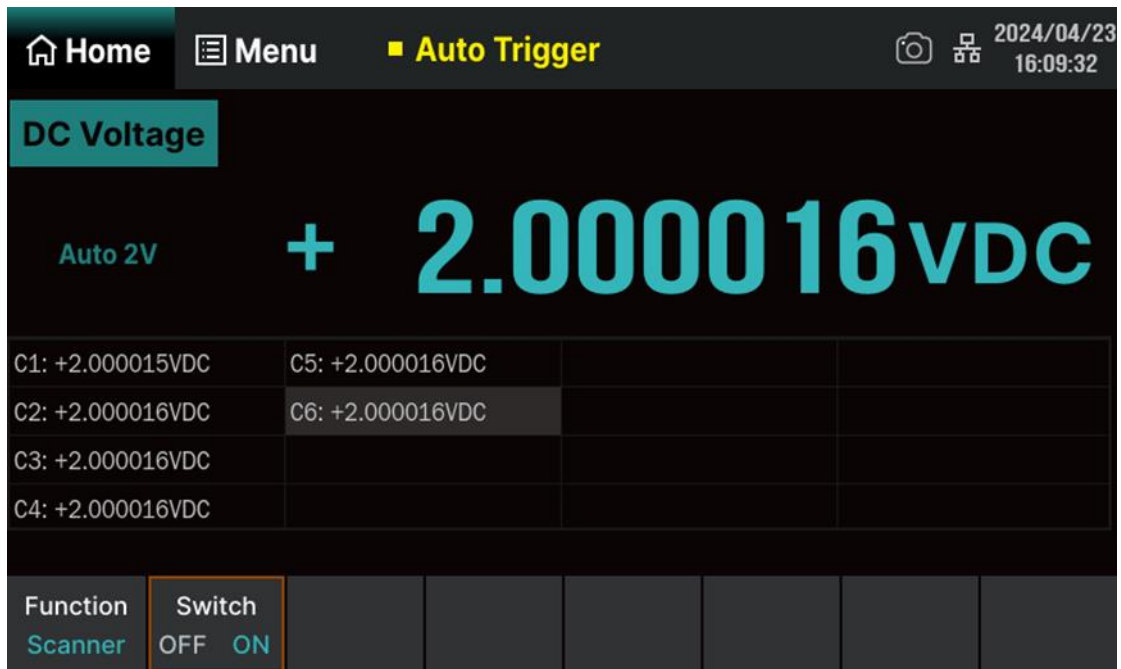

Figure 7-26 Scanner function ON interface

As shown in the above figure, the upper part of the interface displays the measurement function, range, and reading of the current scanning channel. The table below records the measurement results of each channel during this scan.

2. Set scan mode

- **Scan:** Each time triggered, all specified channels will be measured, and after all channel measurements are completed, the timing function will be activated.
- **Step:** Each time triggered, measure a specified channel, and after the measurement is completed, the timing function will be activated.

3. Set Timer

Definition of Timer: In scan mode, the time interval between the end of one scan and the start of the next scan; In step mode, the time interval between the end of one channel measurement and the next channel measurement. You can use the pop-up virtual keyboard to set the timing time, with a range of 0 to 999.999 s and a resolution of 1 ms.

4. Set the cycle mode

- **Auto:** After starting the scanning operation, the multimeter will continuously cycle through the specified channels until the scanning operation is manually turned off.
- **Man:** By manually setting the number of scanning cycles, the range can be set from 1 to 999. After starting the scanning operation, the universal expression will automatically stop scanning after reaching the specified number of scanning cycles.

5. Channel settings

Touch **Channel Setting** to enter the channel setting interface, as shown in the following figure:

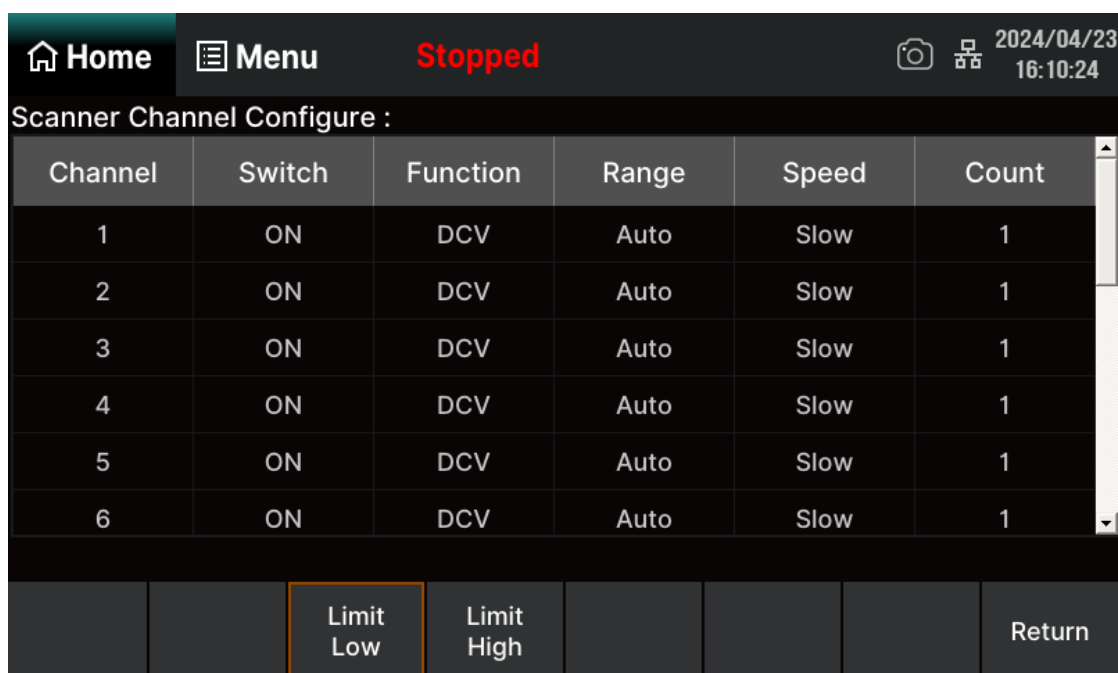

Figure 7-27 Channel setting interface

Table 7-3 Channel setting menu description

Function Menu	Description
Limit Low	Specify the lower number for scanning channels.
Limit High	Specify the higher number for scanning channels.
Return	Return to the higher-level menu.

By touching the **Switch**, **Function**, **Range**, **Speed** or **Count** area of the corresponding channel, the corresponding parameters can be selected and set. as shown in the following figure (taking function setting as an example):

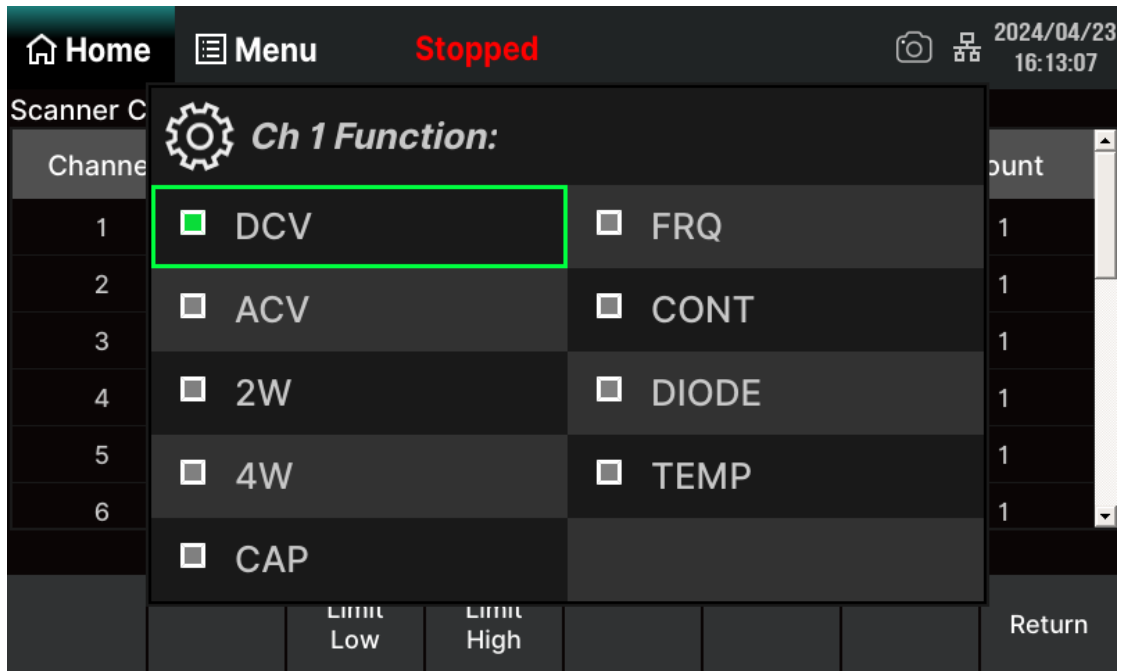

Figure 7-28 Channel configuration interface

The measurement functions with adjustable range include: DC/AC voltage (DCV/ACV), 2-wire/4-wire resistance (2WR/4WR), capacitance (Cap), frequency (Freq), period. Note: The 4-wire resistance(4WR) can only be selected in the first six channels, and after selection, the corresponding channel number plus 6 is set to off and cannot be modified. The corresponding optional ranges are shown in the table below.

Table 7-4 Optional ranges corresponding to measurement function

Function	Optional Range
DCV/ACV/Freq	Auto, 200 mV, 2 V, 20 V, 200 V
DCI/ACI	2 A (fixed range)
2WR/4WR	Auto, 200 Ω , 2 k Ω , 20 k Ω , 200 k Ω , 2 M Ω , 10 M Ω , 100 M Ω
Cap	Auto, 2 nF, 20 nF, 200 nF, 2 μ F, 20 μ F, 200 μ F, 10 mF

The measurement functions that can set the scanning speed include: DC/AC voltage (DCV/ACV), DC/AC current (DCI/ACI), and 2-wire/4-wire resistance (2WR/4WR). The speed can be set to either Fast or Slow.

Operating instructions:

- By pressing the screen settings module to select settings, the background color of the cursor's

position changes to gray.

- The background color of the selected settings changes to green.
- Set the selected parameters through the left/right directional buttons on the front panel or the virtual keyboard that pops up on the screen; Save this setting, and the background color of the parameter area will change from green to gray.
- Continue to repeat the above steps to set the next parameter.
- Press **Return** to save the current configuration and return to the higher-level interface.

6. Set the number of scanning channels

Touch **Limit Low** or **Limit High** and enter a number.

Note: The specified High number should always be greater than or equal to the Low number.

7. Set the display mode (option operation)

Touch **Menu** > **Display** to select the display. Taking the trend chart display mode as an example in the following figure.

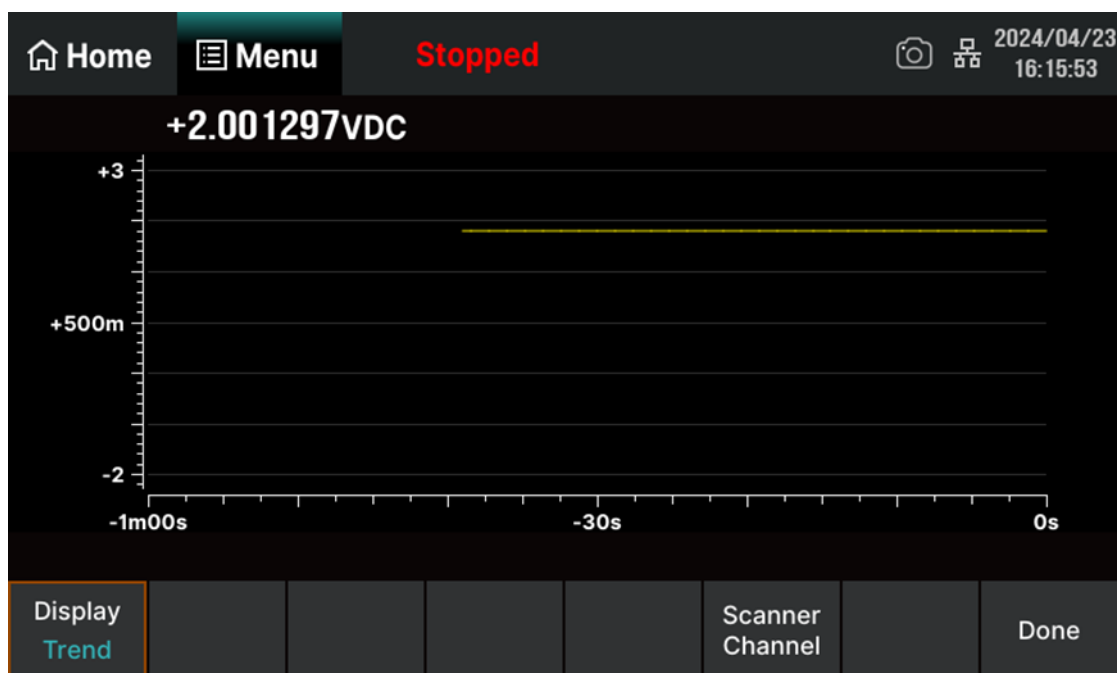

Figure 7-29 Trend display mode interface

For details, please refer to "Display" chapter.

You can also use mathematical statistics function in channel scanning. For more details, please refer to the relevant description in the "Math Function" chapter.

Press the **Home** button on the front panel or touch the **Home** menu on the screen to return to the main interface.

8. Stop scanning

Touch **Switch** > **Off** to disable the scanner function. If the **Cycle** is set to manual, the multimeter will automatically stop scanning after reaching the specified number of cycles.

7.3 Dual-display Function

The Dual-display function is used to turn on two basic measurement functions, and observe the two measurement results at the same time, thus improve the test and measurement functions. For available combinations of Dual-display, refer to the Table 7-5, blank space indicates that the combination is not available.

Table 7-5 Available combination of Dual-display (letters in brackets correspond to Figure 7-31 wiring example)

Correspond to Figure 7-31 wiring example		Main Display Function								
		DCV	DCI	ACV	ACI	Freq	Period	2WR	4WR	Cap
Secondary Display Function	DCV		(a) ⁽¹⁾	(b)	(a)					
	DCI	(a) ⁽¹⁾		(a) ⁽¹⁾	(c)					
	ACV	(b)	(a) ⁽¹⁾		(a)	(b)	(b)			
	ACI	(a)	(c)	(a)						
	Freq			(b)			(b)			
	Period			(b)		(b)				
	2WR								(d)	(e)
	4WR							(d)		
	Cap							(e)		

Remark:

- (1). Because connection (a) reverses the polarity of current line, DCI measurement shows its negative value.

Operating Steps:

1. Enable temperature measurement

Press the **Menu** button on the front panel to enable the main display function, touch the **Dual Function** > **Secondary** on the screen to select the measurement function of secondary display. Then touch the **Switch** menu and set the status to "ON". When the second measurement function is enabled, touch the **Swap Display** on the screen to switch between the main/secondary display. As shown in the following figure.

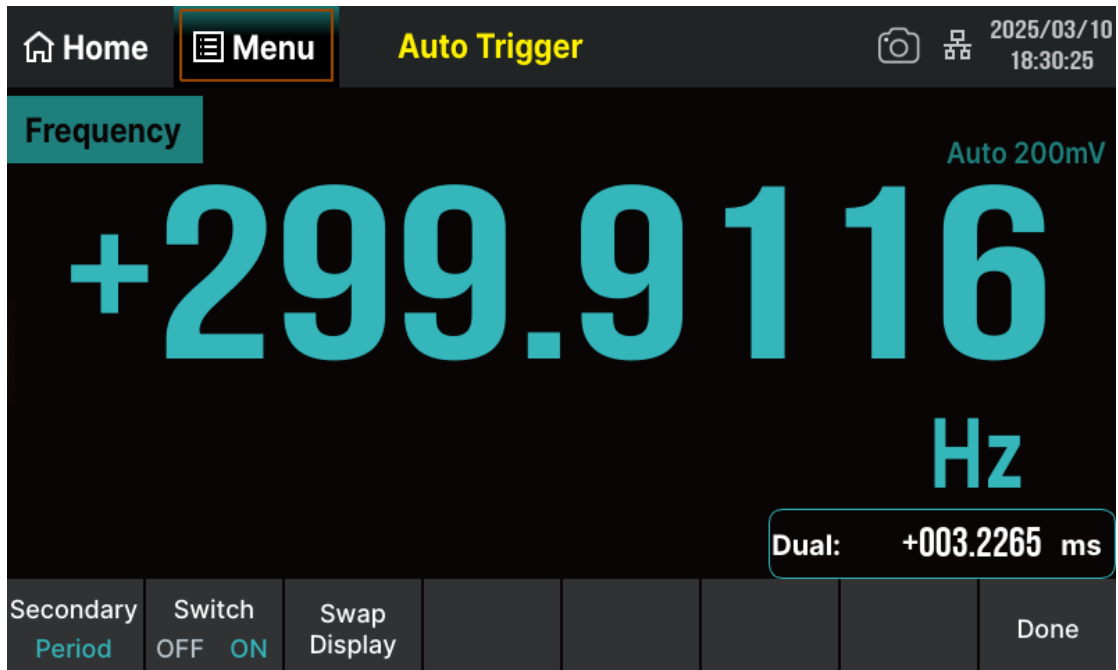

Figure 7-30 Dual-display interface (main display – Freq, secondary display – Period)

2. Make connection

Connect the test leads with the measured signal by referring to “Measurement Connections”. As shown in the Diagram below, power source refers to connecting DC / AC power or not.

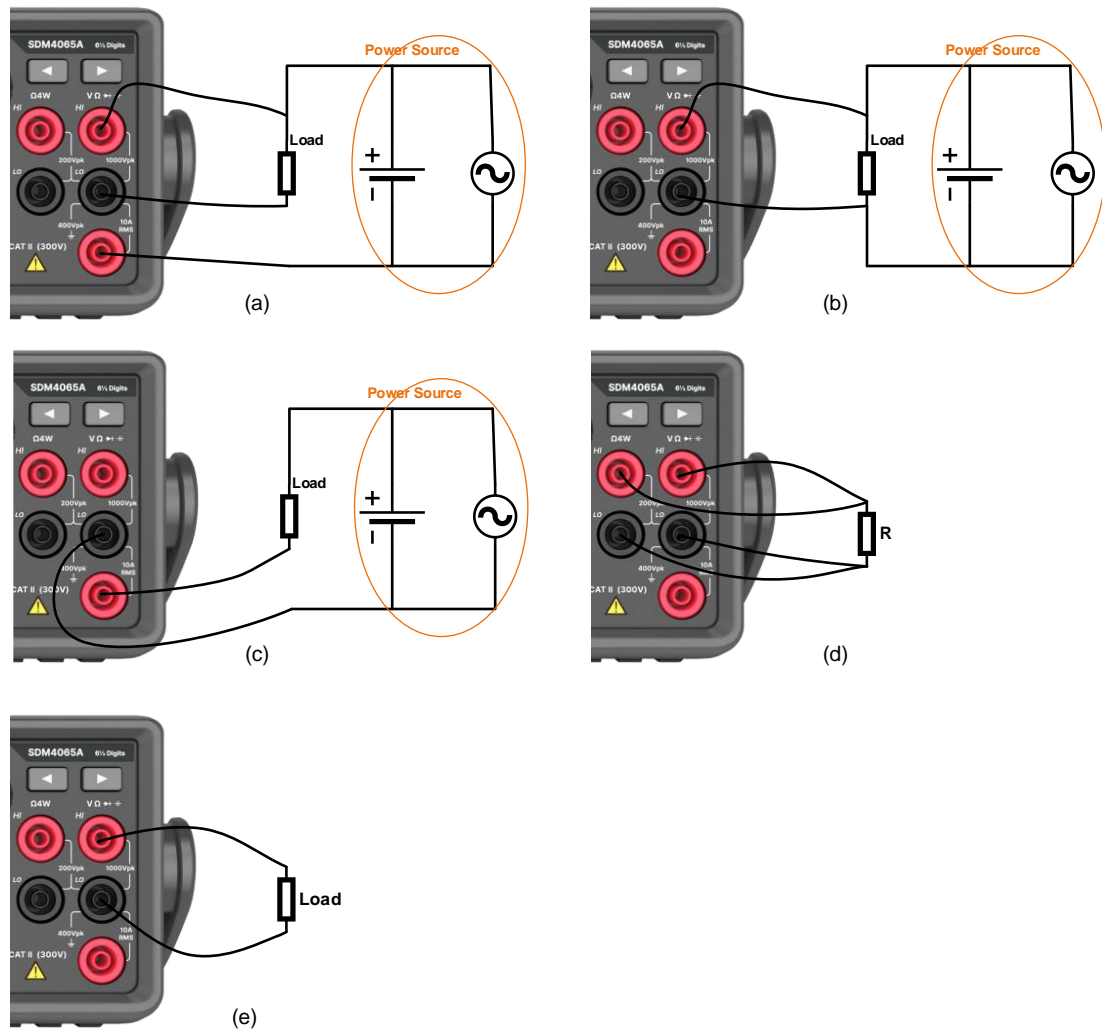

Figure 7-31 Dual-display wiring example

3. Instruction

- 1) If different measurement functions are used in both Main and Secondary Display.
 - The readings in both measurement functions will update alternately, and the relevant configuration information (such as auto zero switch display, relative value display, input impedance display, etc.) is also updated synchronously.
 - If math function (Statistics, Limits, Relative, dB/dBm) is used in Main Display, when opening Secondary Display, the result will still be shown in Main Display and Secondary Display will show the second selected function normally.
- 2) Temp, Cont, and Diode do not support dual display function.
- 3) The configuration of the secondary display should be consistent with the configuration of the second test function before the dual display function is turned on.
- 4) Measured data in secondary display can be saved into "History".

7.4 Utility Function

The Utility function enables users to set up system parameters, interface parameters of the multimeters.

Press **Utility** button on the front panel to enter the operating menu of Utility function, as shown in the following figure.

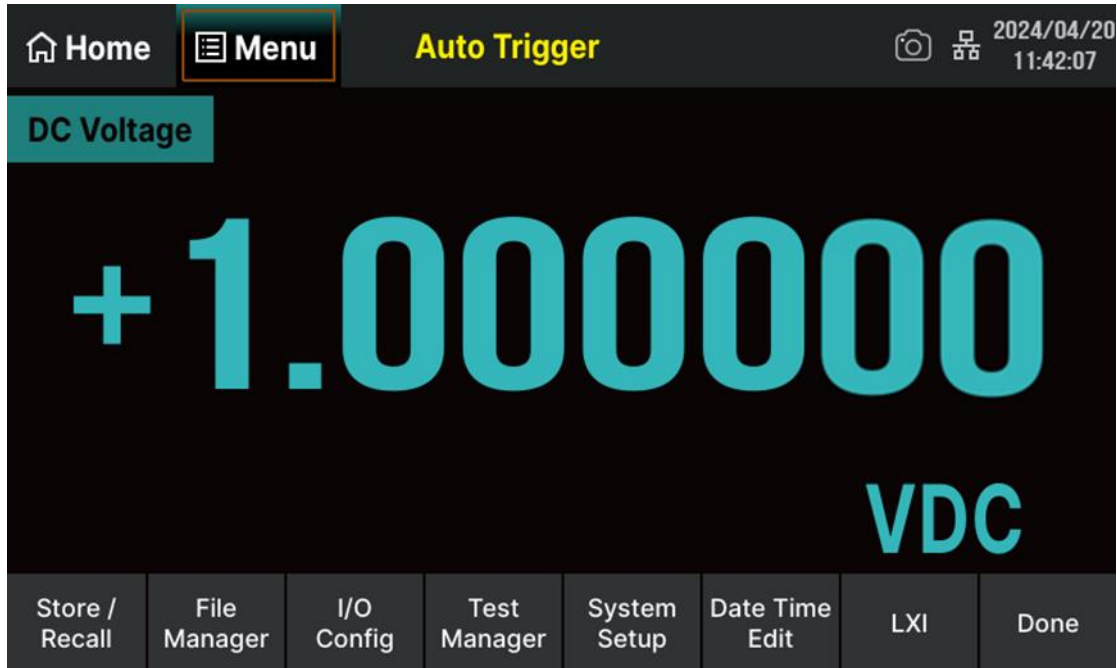

Figure 7-32 Utility function configuration interface

Table 7-6 Utility function menu description

Function Menu	Description
Store/Recall	Store or recall state files.
File Manage	Create a new file, copy, rename or delete a file.
I/O Config	Configure USB, LAN and GPIB interface.
Test Manager	Provide board test function.
System Setup	Configure instrument's user settings.
DateTime Edit	Set the date and time.
LXI	View relevant standard information.
Done	Save current settings and return to the higher-level menu.

7.4.1 Store/Recall

The Store/Recall function enables users to store and recall the instrument state and data files in the local storage as well as in USB storage. Perform **Utility** > **Save/Recall** to enter the following figure.

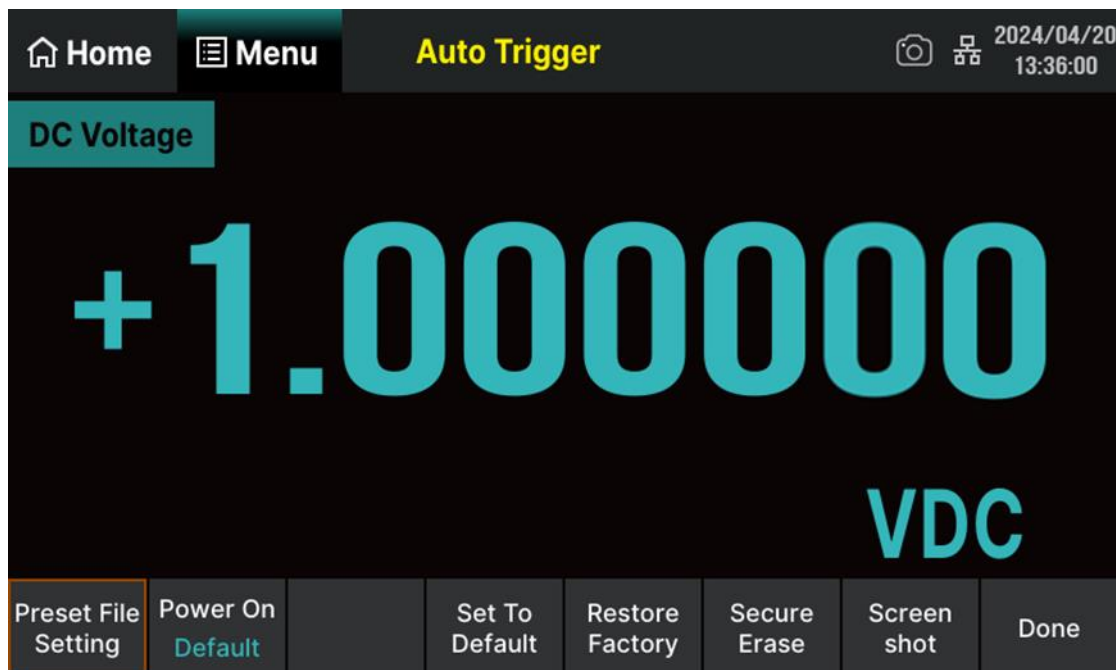

Figure 7-33 Save/Recall interface

Table 7-7 Save/Recall function menu description

Function Menu	Description
Preset File Setting	Save/Read saved files.
Power On	Select the power on mode, and SDM4065A provides three modes: Default, Last, and User.
Set To Default	Restore the default configuration of the multimeter function.
Restore Factory	Restore the default settings of the multimeter function, and also restore the network port, language, power on mode, screen saver, calibration compensation, and screenshot settings.
Secure Erase	Restore factory configuration and deleting all user data.
Screen shot	Set the path and file name for saving.
Done	Return to the higher-level menu.

7.4.1.1 Preset File Setting

You can store system configuration (in the form of .xml) or measurement data (in the form of .csv) in internal memory or an external USB storage device and recall it when required. After entering the Store/Recall operation menu, select the **Preset File Setting** to enter the settings interface as shown in the following figure.

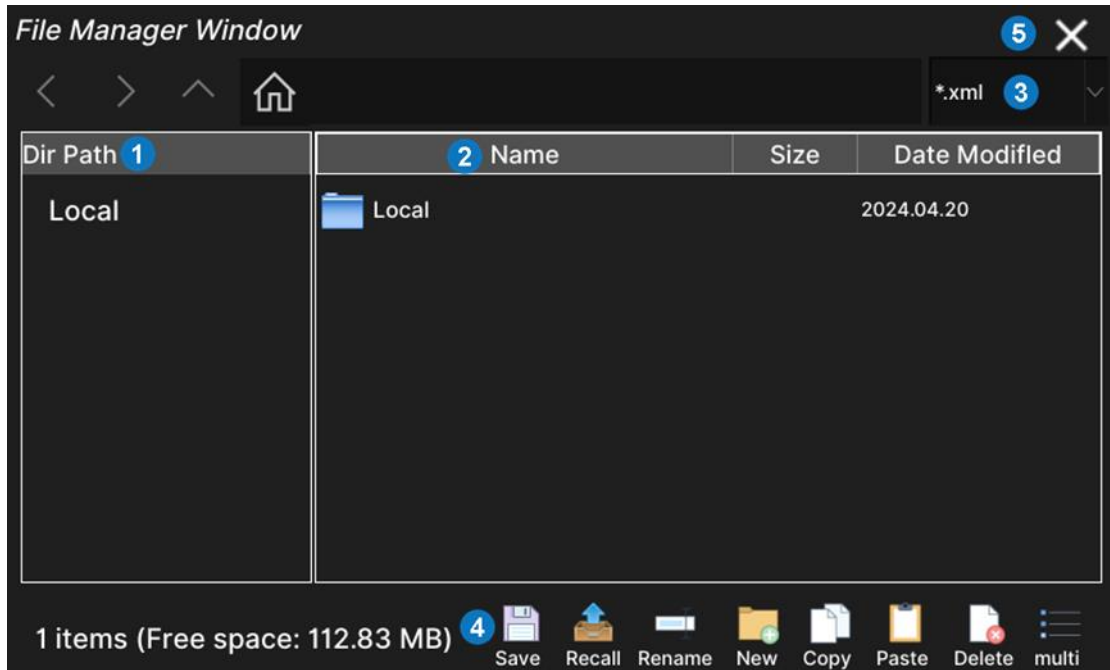

Figure 7-34 Preset file setting interface

No.	Item	Description
1	Dir Path	Select the path to save or recall.
2	Name	Enter or rename the file name.
3	File type	Choose the file type to .xml/.csv. .xml is used to save the current configuration of the multimeter; and. csv is used to save the measurement data of the current function of the multimeter.
4	Operation menu bar	Perform file operations such as Save , Recall , Rename , New , Copy , Paste and Delete files using the currently selected path, file type, and input file name.
5	Close window	Save all settings and close the window.

1. Save the current state of the multimeter to the path of “/Local” with the file name “STATE_1.xml”.

- 1) Select the path

Touch **Preset File Setting** , choose the local path to save the data, then touch **Save** .

- 2) Set the file type and filename

In the interface shown below, select the type of file and enter the name “STATE_1.xml” through the keyboard.

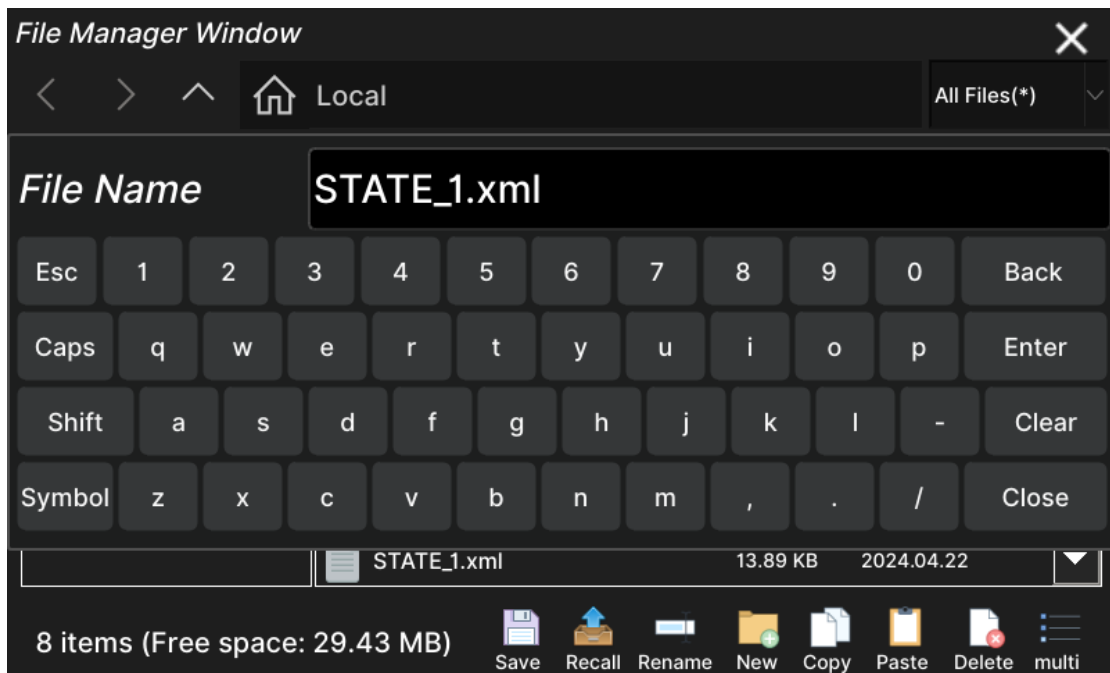

- 3) Save the file

After setting the file type and name, touch "Enter" to complete the save operation. Touch **X** to close the window.

2. Recall the file named “STATE_2.xml” from the path of “Local”.

- 1) Select the path

Touch **Preset File Setting** , Select the path to call the file. As shown in the following figure.

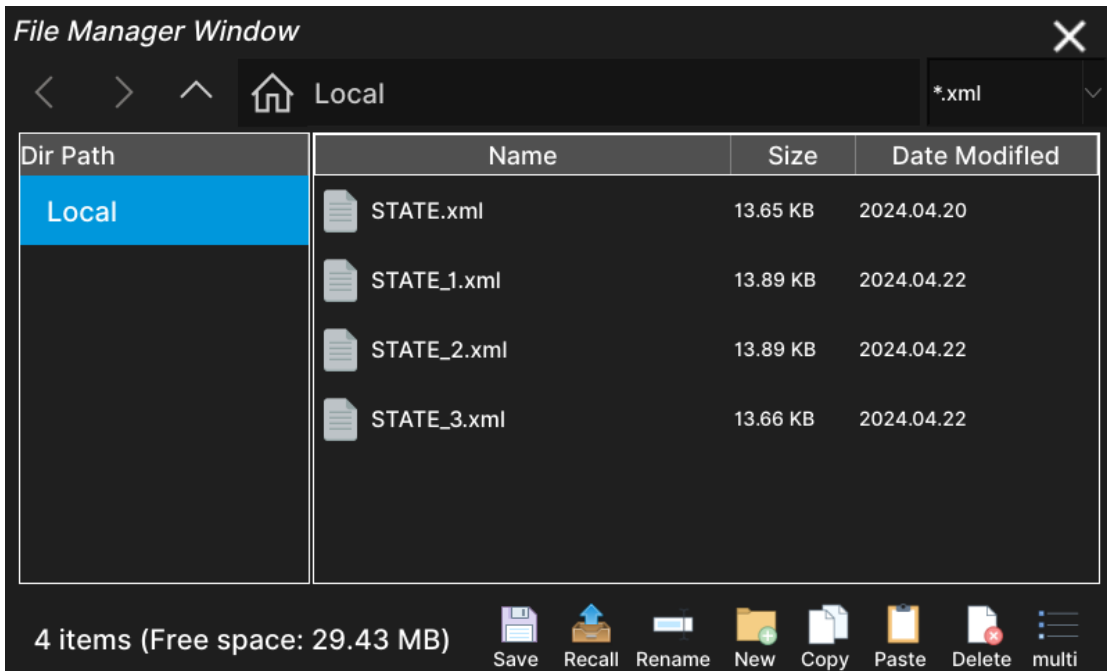

2) Select the file

Select the file named "STATE_2.xml", as shown in the following figure.

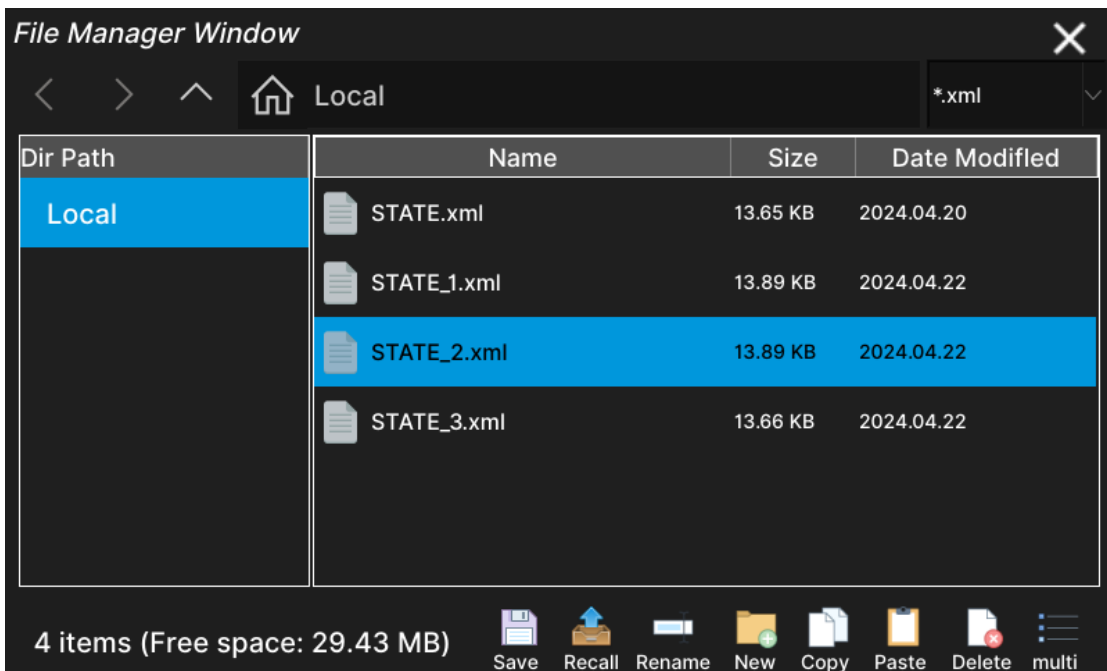

3) Recall the file

Touch **Recall** to recall the file. When the call is completed, a pop-up will prompt that the call was successful.

7.4.1.2 Power On

After entering the Store/Recall operation menu, touch the **Power On** to configure the status of the multimeter when powered on. The power on mode can be set to Default, Last, or User.

- Default: Factory default settings. Except for individual parameters (such as language).
- Last: Configuration at last power-off, including all system parameters and states, except for channel output switch states.
- User: System state previously saved by the user. After selecting “User” as the power-up mode, click **Power On File** to recall the power on file that the user has stored in the local or external USB memory device.

7.4.1.3 Set to Default

After entering the Store/Recall operation menu, touch the **Set To Default**, select **OK** in the pop-up confirmation dialog box to restore the function settings to the default state of the instrument.

7.4.1.4 Restore Factory

After entering the Store/Recall operation menu, touch the **Restore Factory**, select **OK** in the pop-up confirmation dialog box. After performing this operation, the multimeter will restore the default settings of the multimeter function, and also restore the network port, language, power on mode, screensaver, calibration compensation, and screenshot settings. This operation is irreversible, please be cautious.

7.4.1.5 Secure Erase

After entering the Store/Recall operation menu, touch the **Secure Erase**, select **OK** in the pop-up confirmation dialog box. After performing this operation, the multimeter will restore factory configuration and delete all user data. This operation is irreversible, please be cautious.

7.4.1.6 Screen Shot

After entering the Store/Recall operation menu, touch the **Screen shot** to enter the interface as shown in the following figure. You can set the storage path or file name in the corresponding input area.

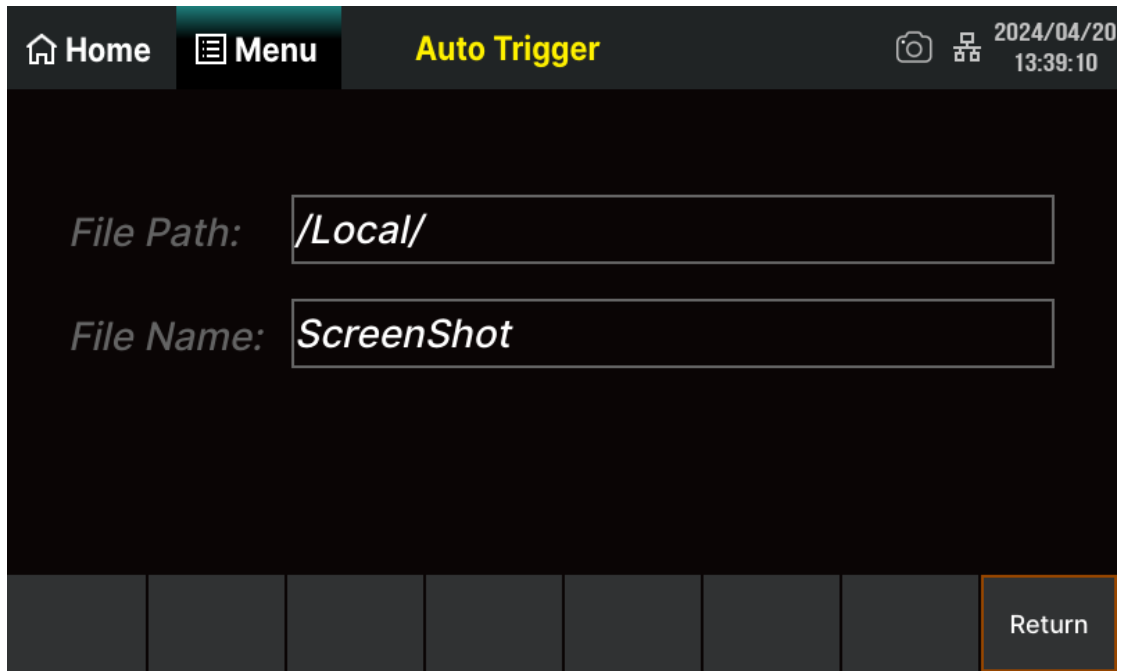

7.4.2 File Manager

The Manage File function enables users to create, save, copy, rename and delete files and folders in the local storage as well as in USB storage.

After entering into the function menu of Utility, touch **Manage File** to enter the manage file interface, as shown in the following figure.

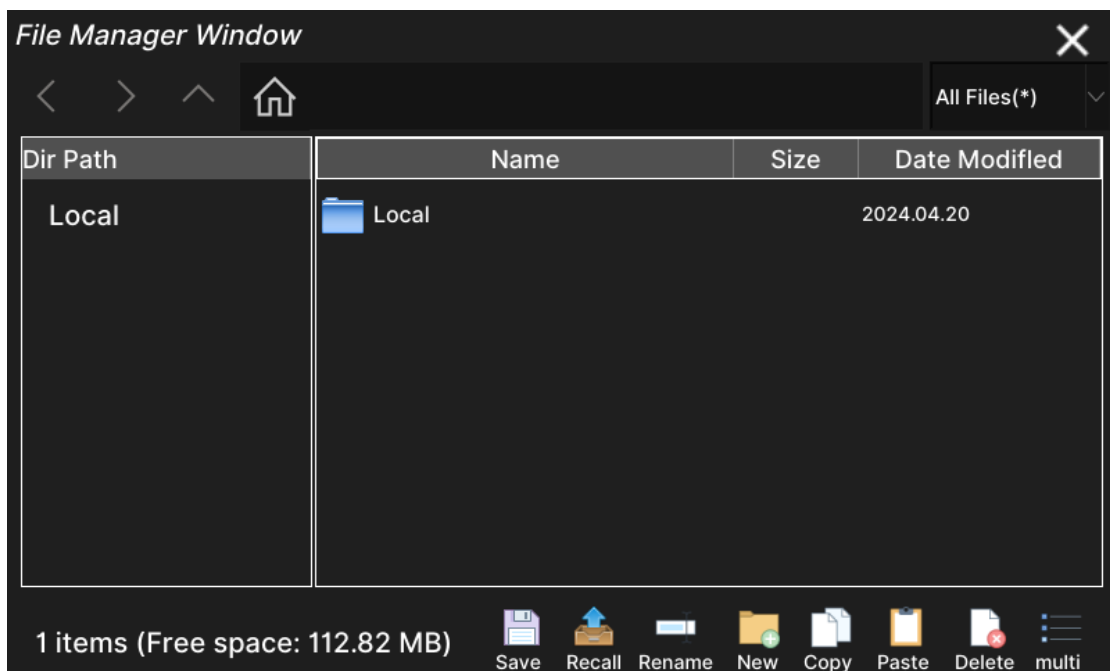

Figure 7-35 Manage file interface

Touch the **Save** , **Recall** , **Rename** , **New** , **Copy** , **Paste** , **Delete** or **Multi** to perform corresponding operations.

- **Save**: Save the current configuration file.
- **Recall**: Load the file.
- **Rename**: To rename a file or folder.
- **New**: Create a folder. After selecting the path to generate the folder, touch **New** , then enter the folder name and generate the folder to the specified path.
- **Copy**: Copy a file or folder. After selecting the path of the file or folder to be copied, touch **Copy** to generate the copied file or folder to the specified path.
- **Paste**: Paste the file or folder to the specified path.
- **Delete**: Delete the file or folder selected.
- **Multi**: Select multiple files.

7.4.3 I/O Configuration

SDM4065A is equipped with USB, LAN (VXI-11), and GPIB (optional) interfaces. Users can set GPIB and LAN interface parameters as needed (USB parameters do not need to be configured). After pressing the **Utility** button on the front panel to enter the operation menu of Utility functions, touch **I/O Config** to open the interface settings menu, as shown in the following figure.

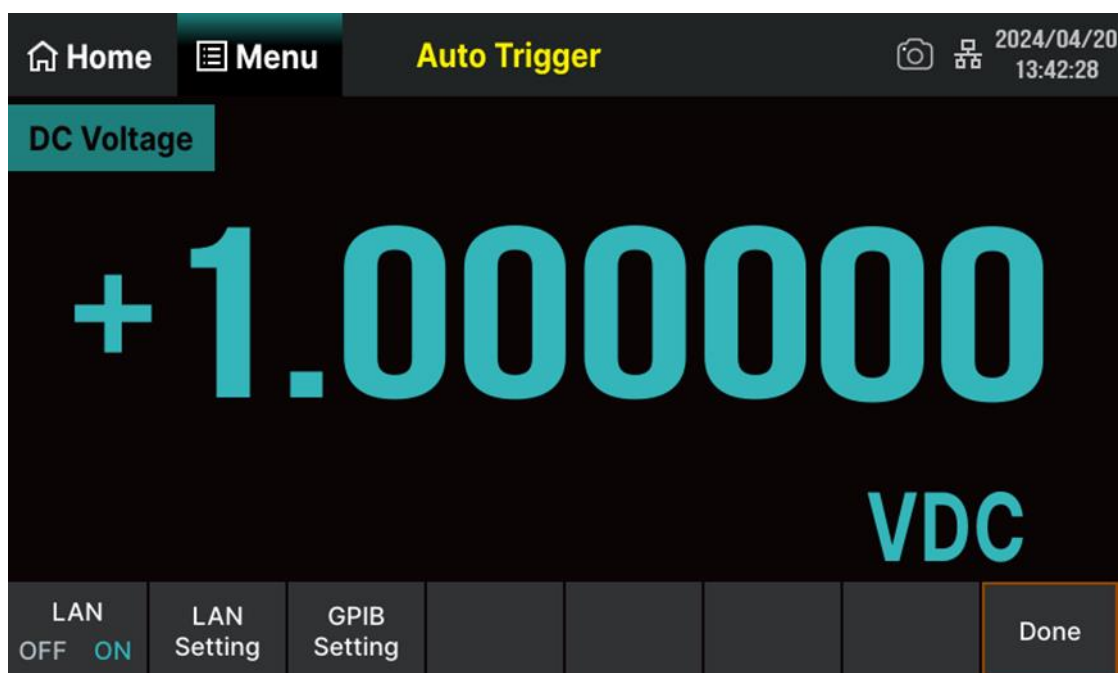

Figure 7-36 I/O configuration interface

SDM4065A can be remotely controlled through the following two methods:

- **User defined programming:**

Users can program and control instruments through the Standard commands for Programmable Instruments (SCPI) command. For detailed instructions on commands and programming, please refer to the programming manual of this product.

- **Using PC software:**

Users can use NI (National Instruments Corporation)'s "Measurement & Automation Explorer" software to control the instruments.

7.4.3.1 USB Setting

SDM4065A supports communication with computers using the USBTMC protocol. You need to complete the following steps to establish a connection.

1. Connect the instrument

Connect SDM4065A (via the USB Device interface on the instrument's rear panel) to the computer using a USB data cable.

2. Install USBTMC driver on the computer

Recommend using NI Visa.

3. Remote communication with computers

- 1) Open the "Measurement & Automation Explorer" software.
- 2) Select the resource name corresponding to the instrument.
- 3) Select "Open VISA Test Panel" to open the remote command control panel, and you can send commands and read data through this panel.

7.4.3.2 LAN Setting

The SDM4065A enables users to operate instrument remotely. You can look over current LAN settings and modify the current LAN configuration.

1. Connect the instrument

Connect SDM4065A to the computer or the local area network where the computer is located using a network cable.

2. Configure network parameters

After entering the I/O configuration menu, set the **LAN** to **ON** and touch **LAN Setting** to enter the interface shown below. You can set the IP address, subnet mask, and gateway.

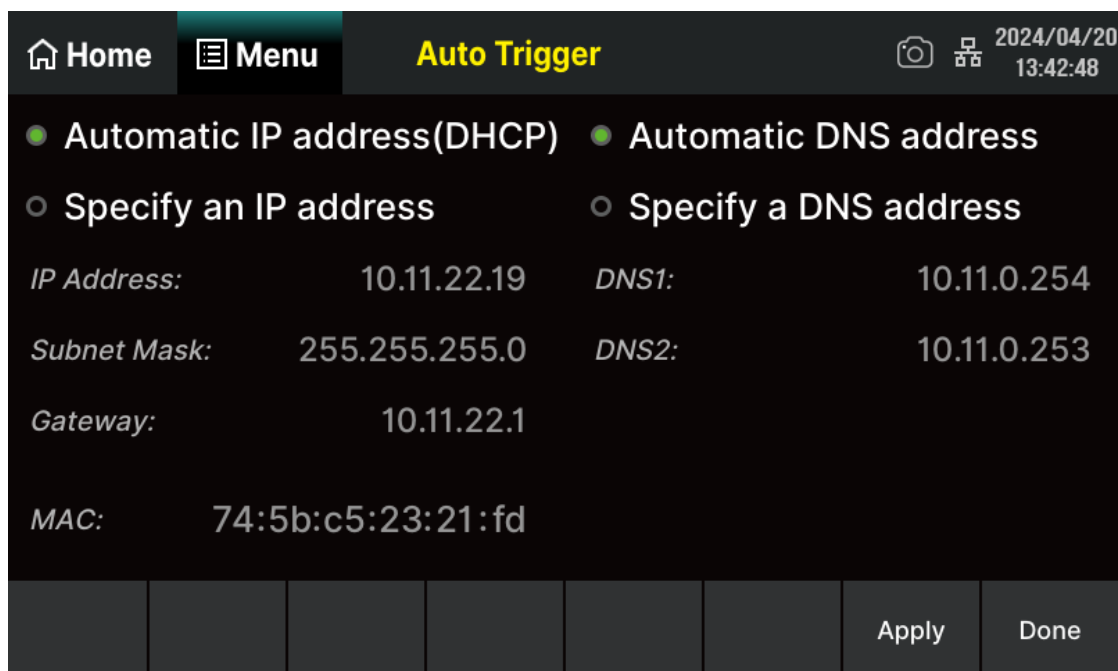

Figure 7-37 LAN setting interface

Table 7-8 LAN settings description

Item	Description
IP Address	Set up IP address.
Subnet	Set up subnet mask.
Gateway	Set up gateway.
Apply	Apply current settings.
Done	Save all changes and return to the higher-level menu.

Explanation:

- If the instrument is directly connected to the computer, set the IP address, subnet mask, and default gateway for the instrument and computer separately. The subnet masks and default gateways of both must be the same, and their IP addresses must be within the same network segment.
- If the instrument is connected to the local area network where the computer is located, please obtain available network parameters such as IP addresses from your network administrator.

Please refer to the TCP/IP network protocol for relevant knowledge.

- The IP address, subnet mask, and gateway settings are saved in non-volatile memory. The instrument will automatically load the relevant settings on the next boot.

3. Remote communication with computers

- 1) Open the "Measurement & Automation Explorer" software.
- 2) Add network devices (VISA TCP/IP Resource...).
- 3) Select the resource name corresponding to the instrument.
- 4) Select "Open VISA Test Panel" and open the remote command control panel, and you can send commands and read data through this panel.

7.4.3.3 GPIB Setting

The SDM4065A multimeter can be optionally equipped with a GPIB interface. The default GPIB address is 18 when the instrument is leaving the factory. The address of Multimeter can be any integral value between 1 and 30. The set address is saved in non-volatile memory.

1. Connect the instrument

Connect SDM4065A to your computer using the USB-GPIB module (optional) and ensure that your computer has a GPIB card installed. Connect the USB end of the USB-GPIB module to the USB Host interface on the SDM4065A front panel, and connect the GPIB end of the USB-GPIB module to the GPIB card port on the computer.

2. Install GPIB card drivers on the computer

Please correctly install the GPIB card driver connected to the computer.

3. Set the GPIB address of the instrument

After entering the I/O configuration operation menu, select **GPIB setting**, and you can use the pop-up virtual keyboard to enter the desired values, as shown in the following figure. After entering, press **Enter** to save the current settings.

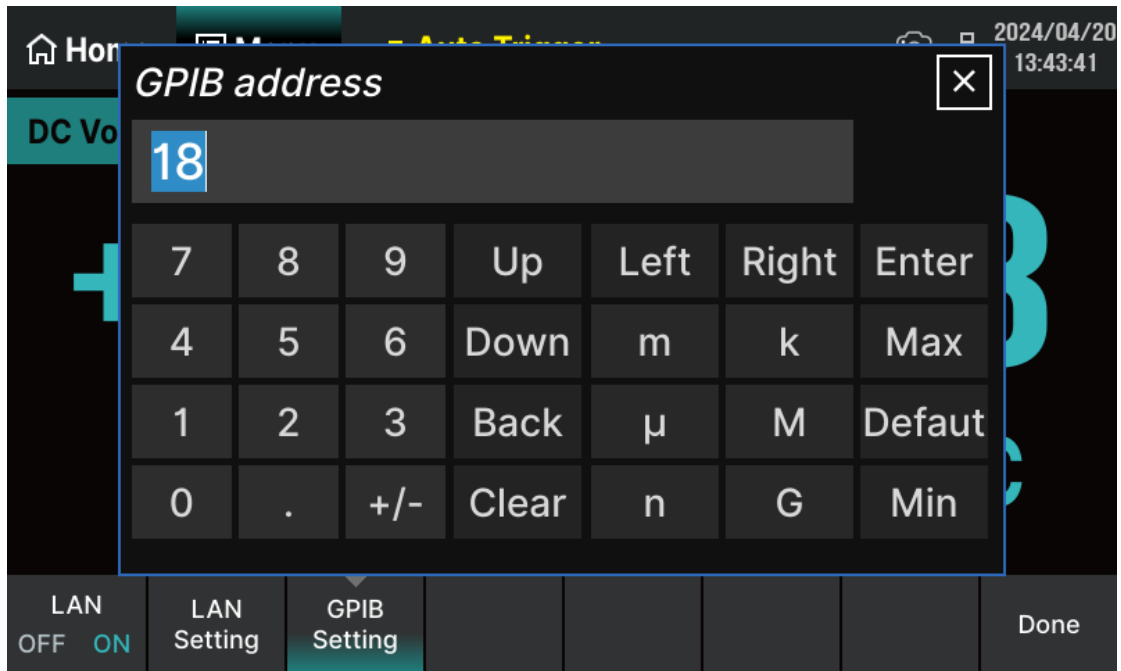

Figure 7-38 GPIB setting interface

4. Remote communication with computers

- 1) Open the Measurement & Automation Explorer software.
- 2) Add GPIB devices.
- 3) Open the remote command control panel, and you can send commands and read data through this panel.

7.4.4 Test Manager

SDM4065A provides self-test functions, including Button Test, LCD Test and Buzz Test.

Perform **Utility** > **Test Manager** enter the test manager interface, as shown in the following figure.

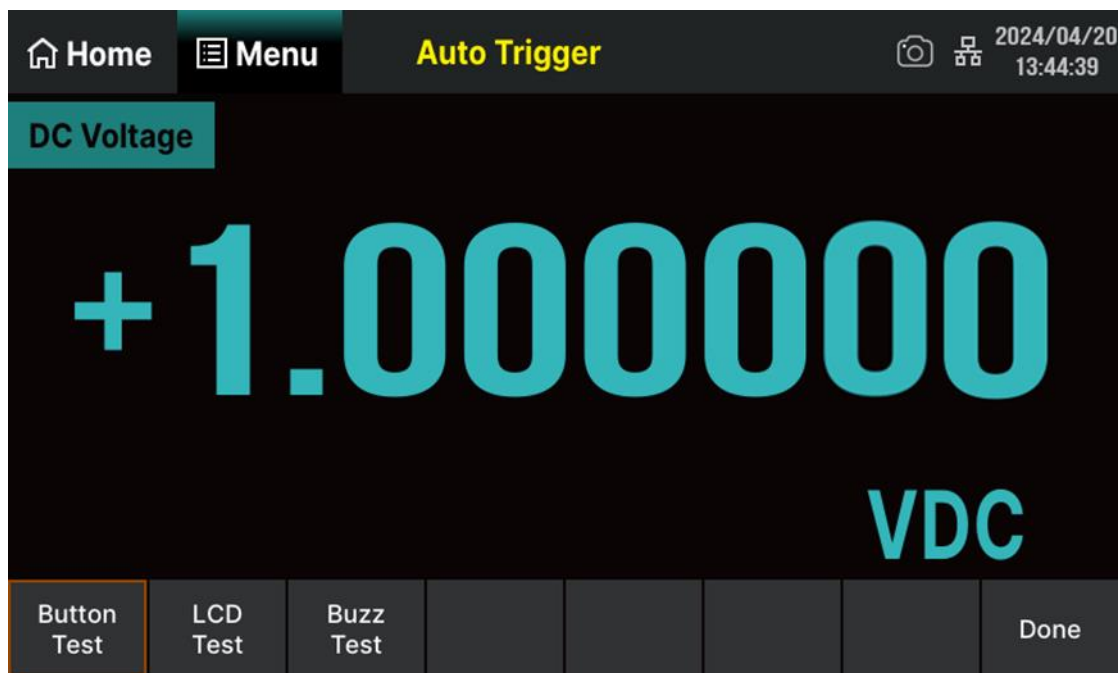

Figure 7-39 Test manager interface

Table 7-9 Test manager function description

Function Menu	Description
Button Test	Test the instrument's buttons.
LCD Test	Test the instrument's LCD screen.
Buzz Test	Test the instrument's buzzer.
Done	Return to the higher-level menu.

7.4.4.1 Button Test

Touch **Button Test** to enter the button test interface, as shown in the following figure. The graphic area on this interface represents the corresponding buttons and knob on the panel. Test all buttons and knob separately to see if they react correctly.

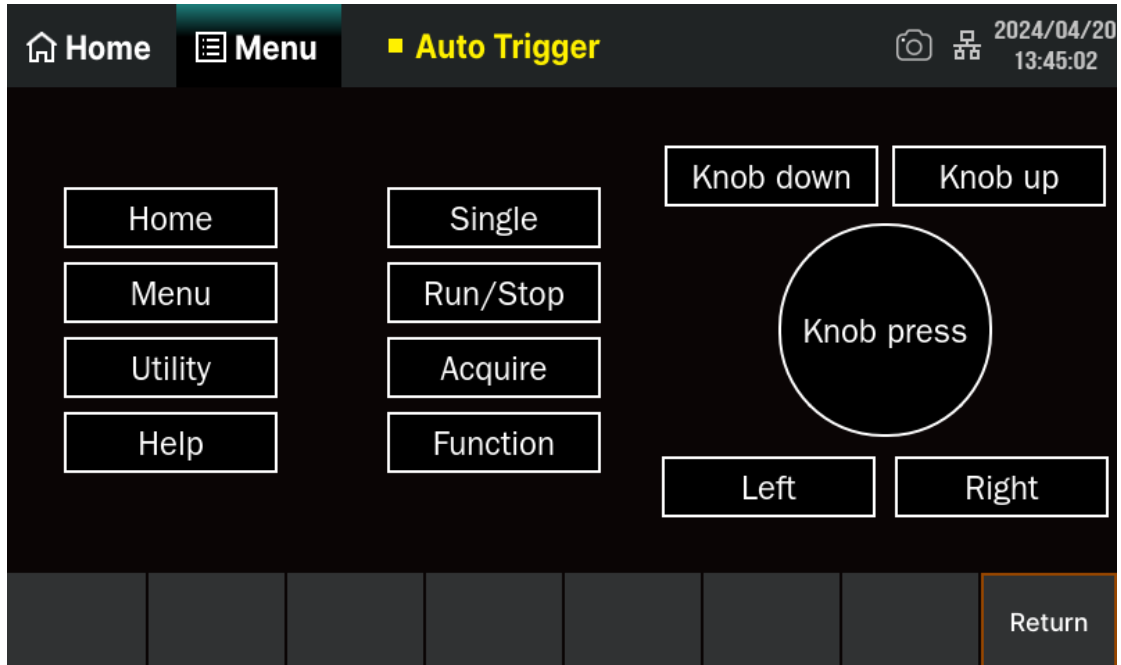

Figure 7-40 Button test interface

Operating instructions:

- Before pressing the button, the background color of the button on the screen is displayed as black;
- After pressing the button, the corresponding button background color is displayed in green;
- Press the **Return** button in the bottom right corner of the screen to exit the test.

7.4.4.2 LCD Test

Touch **LCD Test** to enter the LCD test interface. Press the **Start** button to start the test, and the entire screen will display in pure white first. Touch the screen and it will display in pure red, and prompt messages "Press screen to LCD test." and "Double click to exit.". Follow the prompts and observe whether the screen has serious color deviation, stains, or screen scratches. As shown in the following figure:

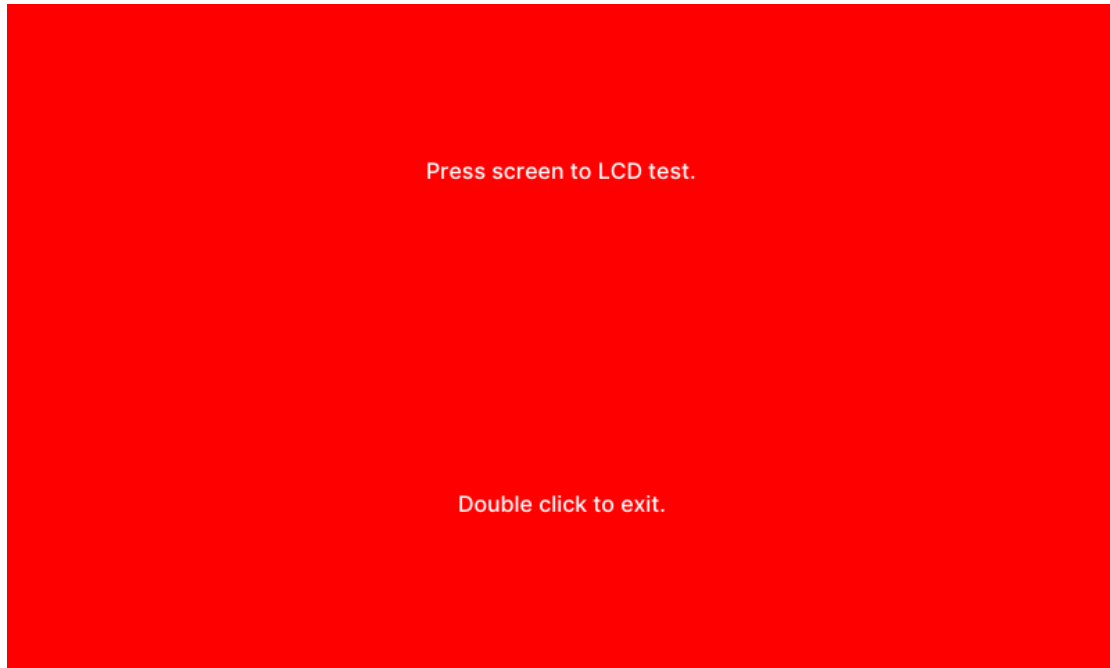

Figure 7-41 LCD test interface

Operating instructions:

- During testing, click on the screen to change the screen color, which includes three colors: red, green, and blue;
- Double click on the screen to exit the test.

7.4.4.3 Buzz Test

Touch **Buzz Test** to perform the buzz test. Under regular circumstances, press **Buzz Test** button once and the instrument will emit a buzz.

7.4.5 System Setup

After entering the Utility function menu, touch **System Setup** to enter the system settings menu interface, as shown in the following figure.

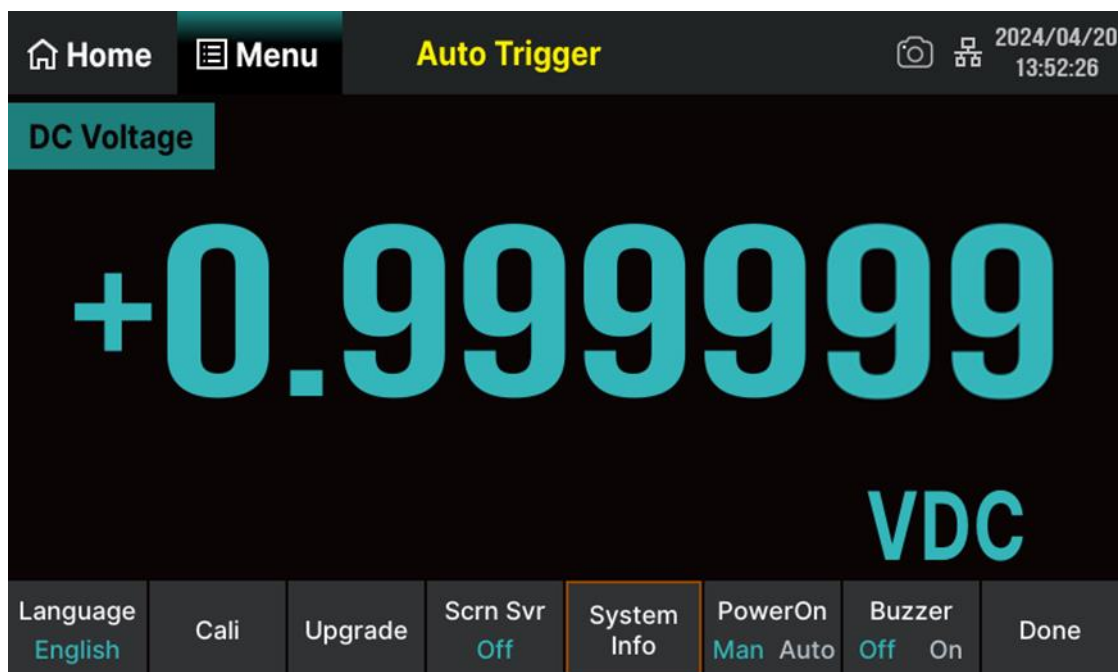

Figure 7-42 System setup interface

Table 7-10 System setup function description

Function Menu	Description
Language	Set the display interface language.
Cali	Entrance for factory calibration and user-defined calibration.
Upgrade	Upgrade software version.
Scrn Svr	Enable or disable screen saver function.
System Info	View system information about the multimeter.
PowerOn	Set power on mode: manual or automatic.
Buzzer	Turn on or off the buzzer.
Done	Return to the higher-level menu.

7.4.5.1 Language

The multimeter supports two kinds of languages: English and Chinese. Press **Language** to select the Language. All operation menus and help information are displayed in the selected language.

7.4.5.2 Calibration

The multimeter provides two calibration modes: **Factory** and **User**.

- **Factory**: Perform factory calibration.
- **User**: Perform user-defined calibration.

7.4.5.3 Upgrade

The software of the Multimeter can be updated directly via USB flash drive, updating current software version to desired software version.

Operating Steps:

1. Copy the update file to the USB flash drive.
2. Insert USB flash drive to USB host interface on the front panel of the Multimeter.
3. Perform **Utility** > **System Setup** > **Upgrade**, select the update file, then touch **Upgrade** > **OK** to start updating the system software.
4. After the upgrade is completed, the screen will prompt "Firmware Update Done!" and the machine will automatically restart.
5. After restarting the device, check the version information.
Perform **Utility** > **System Setup** > **System info** to check if the upgraded software and hardware version numbers match the target version. If not, the updating is failed and you need update once more as the above steps.
6. After checking, touch **Done** to exit the system information interface.



Don't cut off the power during the instrument is updating.

7.4.5.4 Screen Saver

Press **Scrn Svr** to set the screen saver time to 1 minute, 5 minutes, 15 minutes, 30 minutes, 1 hour, 2 hours, 5 hours, or turn off the screen saver function according to different needs. After enabling the screen saver function, if there is no operation during the set time period, the instrument enters the

screen saver state and touch any position on the screen to exit the screen saver.

7.4.5.5 System Information

Press **System Info** to view system information, including product name, software version, serial number, FPGA version, scope ID, hardware version, BKF version and start-up times, as shown in the following figure. Touch the **Return** button to return to the higher-level interface.

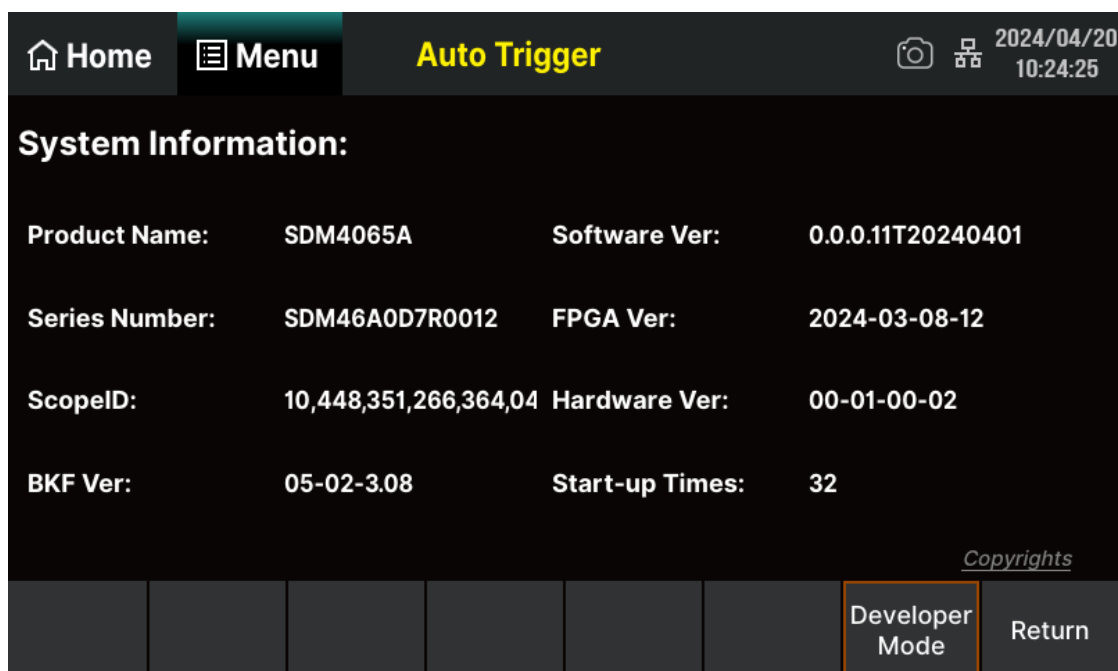

Figure 7-43 System information interface

7.4.5.6 Power On

Perform **PowerOn** > **Man/Auto** to set the startup type to manual or automatic according to different needs.

Auto Power On

When the "Auto" option is selected, once the multimeter is connected to the AC power supply through the power cord, the multimeter boots automatically. This is useful in automated or remote applications where physical access to the instrument is difficult or impossible.



Power on by Manual

When the "Man" option is selected, the power button on the front panel is the only control for the power state of the oscilloscope. The multimeter can only be turned on by manually pressing down the power button.

7.4.5.7 Buzzer

Perform **Buzzer** > **Off/On** to enable or disable the buzzer.

7.4.6 Date Time Edit

Touch the **Date Time Edit** menu, and in the pop-up setting interface, you can use the  or  button corresponding to the parameters to adjust the values. After setting up, touch the **OK** button to save the current time setting, as shown in the following figure.

You can also quickly set the year, month, and day in the pop-up calendar menu interface by touching icon .

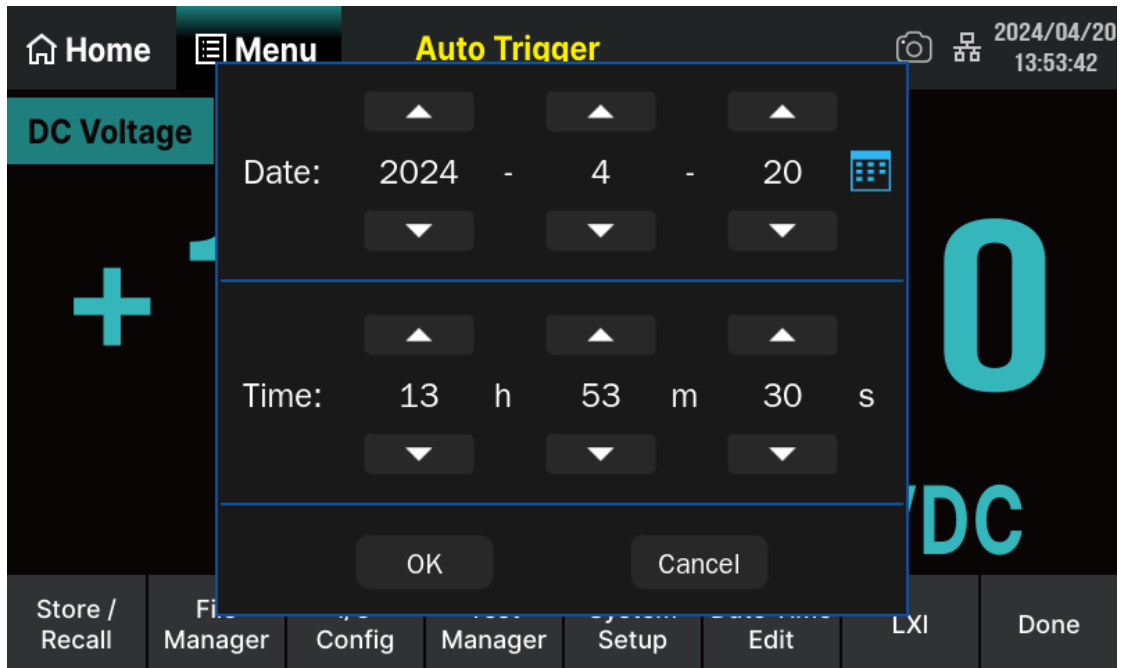

Figure 7-44 Time editing interface

7.4.7 LXI

LXI is a modular testing platform standard based on local area networks. LXI instrument is a new type of instrument strictly based on IEEE 802.3, TCP/IP, network bus, network browser, IVI-COM driver, clock synchronization protocol (IEEE1588), and standard module size.

Touch **LXI** menu to view the information about LXI.

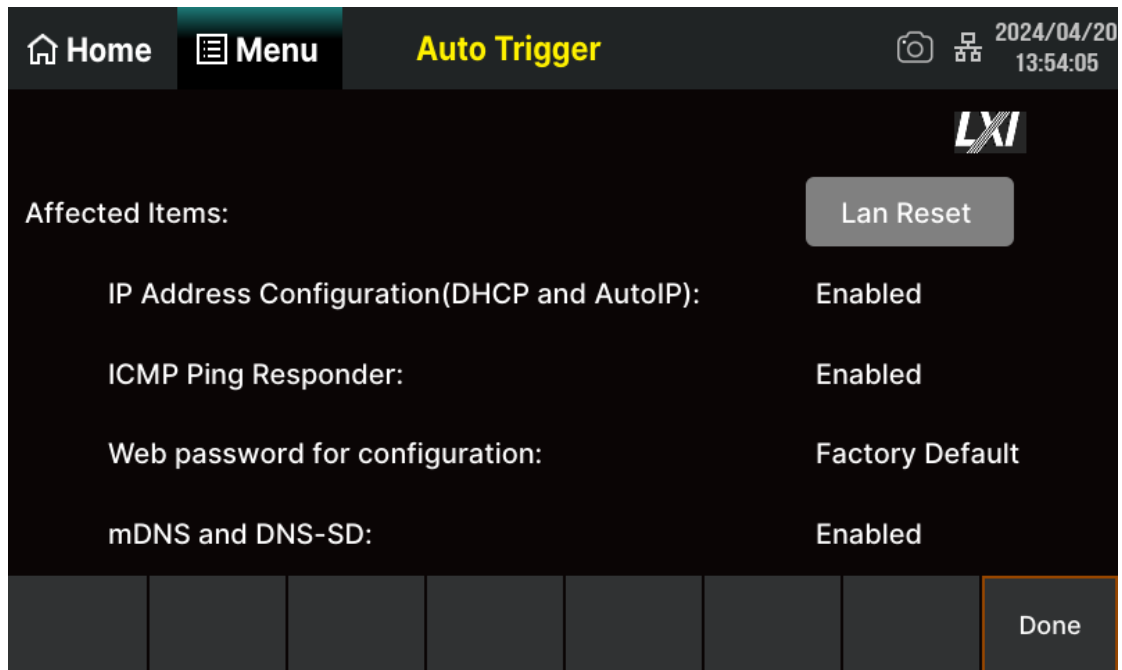

Figure 7-45 LXI information interface

7.5 Trigger and Acquire

SDM4065A provides multiple acquire mode: Auto, Single, Ext, and Level. The multimeter can read one or a specified number of readings each time it receives a trigger signal, and the delay time between the trigger and the reading can be set.

Press button on the front panel to enter the operating menu of Acquire, as shown in the following figure.

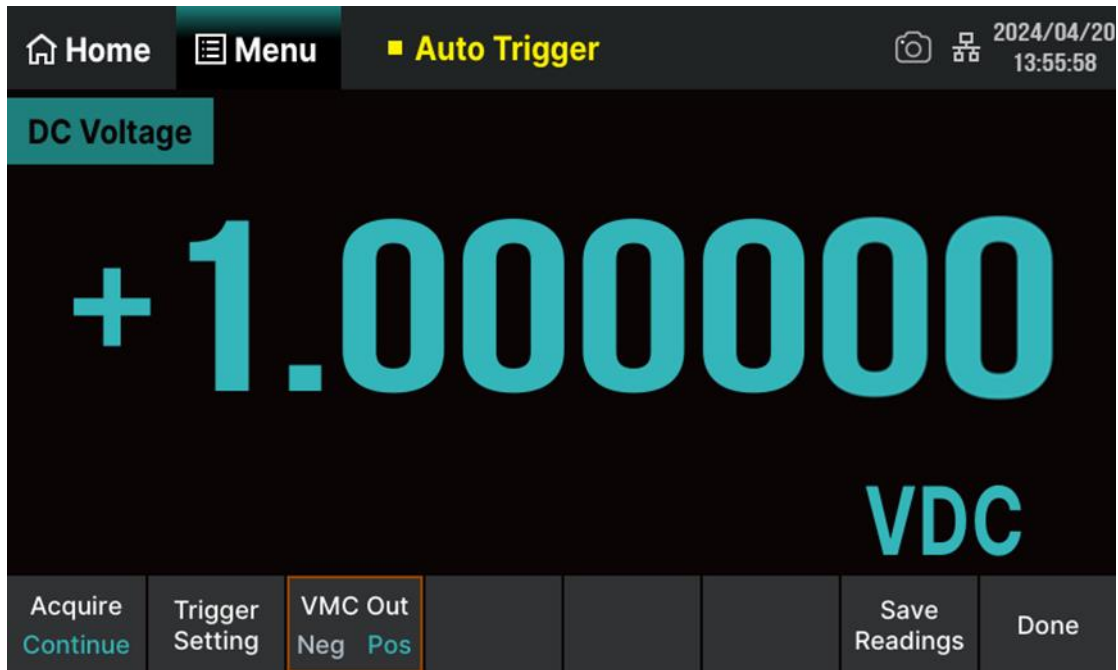

Figure 7-46 Acquire interface

7.5.1 Sampling Rate

Sampling frequency, also known as sampling speed or sampling rate, defines the number of samples extracted from a continuous signal and composed of a discrete signal per unit time, expressed in Hertz (Hz). The reciprocal of the sampling frequency is the sampling period, also known as the sampling time, which is the time interval between samples. Simply put, sampling frequency refers to how many signal samples a computer can collect per unit of time.

Nyquist or sampling theorem states that if a continuous and bandwidth limited signal does not contain frequency components higher than F , the original signal can be restored without distortion (sawtooth) when sampled at a rate greater than $2F$ samples per second. The sampling rate of a multimeter must be greater than twice the frequency component of the measured signal.

7.5.2 Acquire Mode

SDM4065A provides three acquire mode: Continue, Data Log, Digitize, as shown in the following figure.

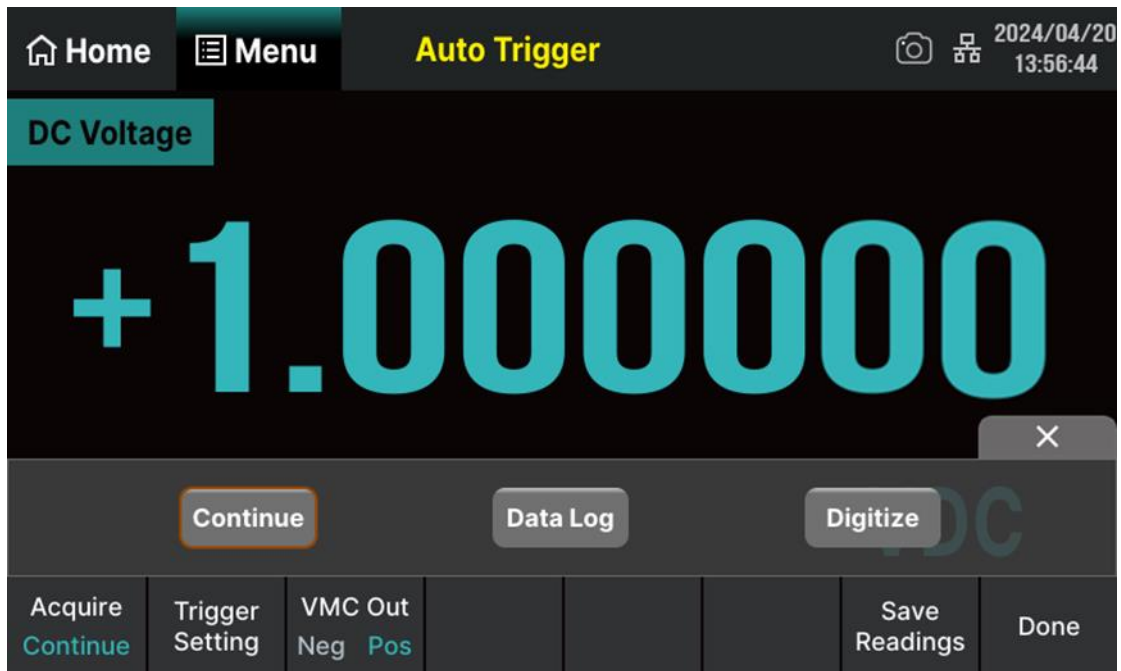

Figure 7-47 Acquire mode setting interface

7.5.2.1 Continue Mode

Perform **Acquire** > **Acquire** > **Continue** to enable continuous sampling mode

Continue mode is the default mode applicable to all functions of a digital multimeter. When using the factory default settings, the digital multimeter can continuously measure with automatic range adjustment and automatic zeroing enabled, and NPLC set to 10 PLC.

Table 7-11 Continue mode function menu description

Function Menu	Setting	Description
Acquire	Continue/Data Log/Digitize	Set the mode of acquire.
Trigger Setting	Trg src	Set the source of trigger to Auto/Single/Ext/Level.
	Delay	Set delay automatically or manually.
	Samples/Trigger	Set the number of sampling times.

	Sample	Set the trigger mode for sampling delay: Immediate sampling or Timed sampling.
VMC Out	Positive/Negative	Set the polarity of output pulse signal when sampling signal is finished.
Save Readings		Save the current cached measurement readings to local or external devices.
Done		Return to the higher-level menu.

7.5.2.2 Data Log Mode

The Data Log mode supports recording a specified number of readings or readings collected during a specified time period to the instrument's memory or internal/external data files without programming and without connecting to a computer. After collecting the data, you can view it on the front panel interface or transfer it to the computer.

The Data Log mode can be used for measurement functions such as DCV, DCI, ACV, ACI, $\Omega 2W$, $\Omega 4W$, frequency, period, capacitance, temperature, etc.

Operating Steps:

1. Enable Data Log function

Perform **Acquire** > **Data Log** to enable Data Log function, and "Data log Stopped" is displayed at the top of the screen. Touch **Single** or **Run/Stop** to start data logging. At this time, "Data Logging" will be displayed at the top of the screen, and the interface will display information such as the number of readings and remaining sampling times. As shown in the following figure.

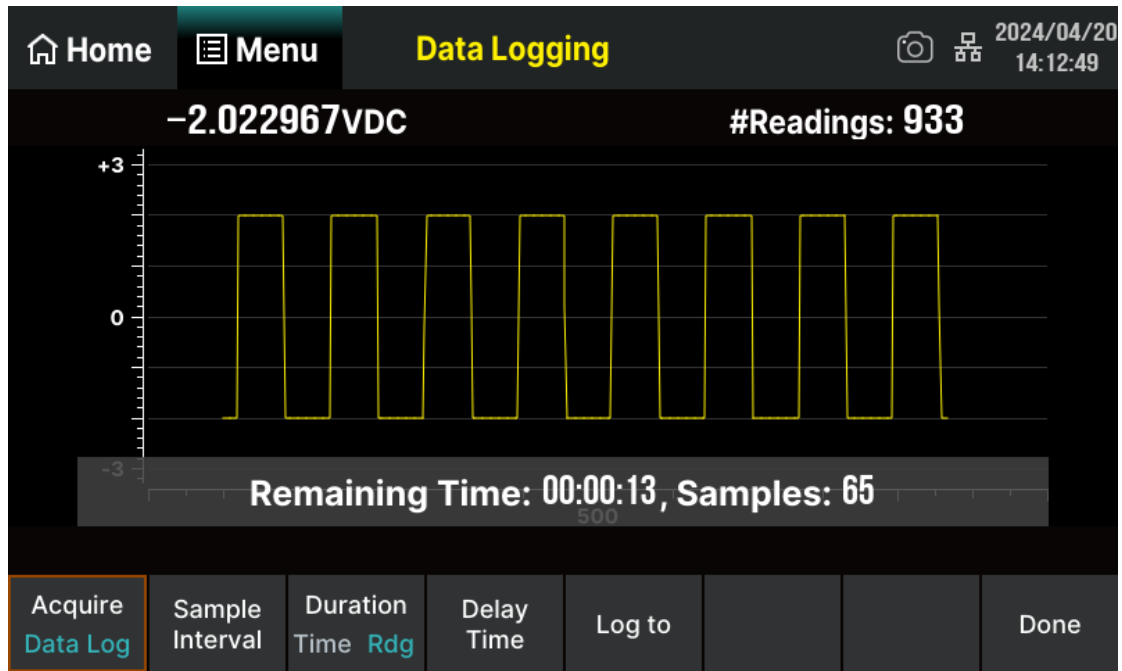

Figure 7-48 Data Log interface

Table 7-12 Data Log function menu description

Function Menu	Setting	Description
Acquire	Continue/Data Log/Digitize	Set the mode of acquire.
Sample Interval		Set the interval time for sampling.
Duration	Time/Rdg	Set the sampling duration or number of readings.
Delay Time		Set sampling delay time.
Log to	Memory/File	Set the storage address for recording data.
Done		Return to the higher-level menu.

2. Set interval time

Set the sampling interval time between two measurement data. Touch the **Sample Interval** and set the interval time on the pop-up virtual keyboard. The interval time can be set within the range of 1ms to 3600s, with a default interval time of 1s.

3. Set duration

Touch **Duration** button.

- When the selected mode is **Time**, you can enter a time value on the pop-up virtual keyboard.

The longest data recording duration is 100 hours, and the shortest data recording duration is 1 second.

- When the selected mode is **Rdg**, you can enter a number of readings on the pop-up virtual keyboard. The maximum data recording rate is 1000 readings per second.



The maximum read rate may be limited by the parameters already configured before enabling the Data Log function (especially the NPLC settings used for DC and resistance measurement). In this case, please select the measurement function (such as DCV) and modify the integration time.

4. Set delay time

Set the waiting time for the first sampling point to start. Touch **Delay Time** to set the delay time on the pop-up virtual keyboard.

5. Set storage path

Touch **Log to**, and then select **Memory** or **File** to log the readings to internal storage space or external files. The maximum number of readings recorded to internal storage is 2M, and to external storage is 360M.

When log readings to memory, the trend chart maps each reading to a point in a pixel column, connects multiple points in each column into a line, and then connects the last reading in the column with the first reading in the next column into a line. If there are too many readings to save to memory, the behavior of the trend chart is similar to that of continuous measurement mode. That is, the number of readings displayed in each pixel column depends on the reading rate and the selected time window.

6. Save Readings

When recording to memory, after running the configuration parameters, you can save the data according to the setting prompts of the menu bar function keys for setting. As shown in the following figure.



7.5.2.3 Digitize Mode

Digitization refers to the process of converting continuous analog signals (such as sine waves) into a series of discrete samples (readings). The Digitize function can only be enabled from the menu bar on the display interface, and parameters can be quickly set on the Digitize function interface. This mode can only be used for DCV or DCI measurement functions.

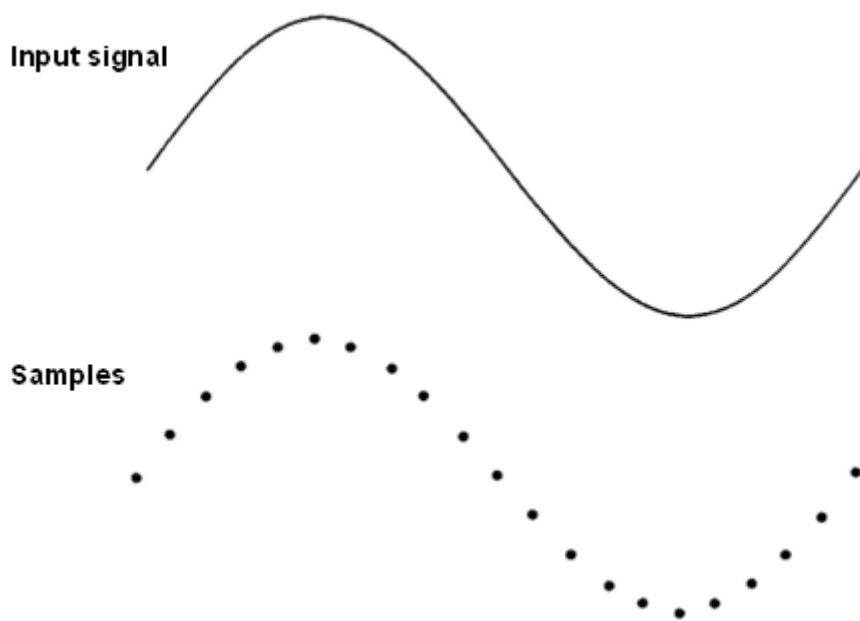

Operating Steps:

1. Enable Digitize function

Perform **Acquire** > **Digitize** to enable Digitize function, and "Digitize stopped" is displayed at the top of the screen. Touch **Single** or **Run/Stop** to start data digitizing. After digitization, "Digitize Stopped" will be displayed at the top of the screen, and the interface will display information such as the number of readings and remaining sampling times. As shown in the following figure.

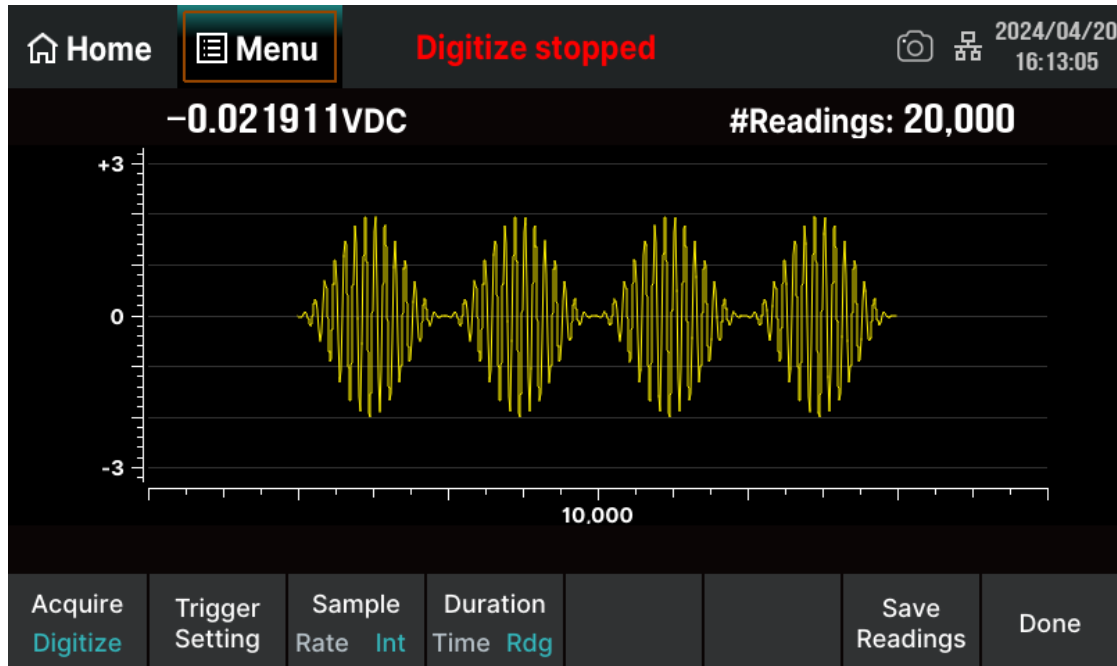

Figure 7-49 Digitize interface

Table 7-13 Digitize function menu description

Function Menu	Setting	Description
Acquire	Continue/Data Log/Digitize	Set the mode of acquire.
Trigger Setting	Trg Src	Set the source of trigger to Auto/Ext/Level.
	Delay	Set delay automatically or manually.
Sample	Rate/Int	Set the frequency and interval of sampling.
Duration	Time/Rdg	Set the sampling time or number of readings.
Done		Return to the higher-level menu.

2. Trigger setting

Perform **Trigger Setting** > **Trg Src** to select the trigger source: Auto, Ext or Level.

Perform **Trigger Setting** > **Delay** > **Auto** or **Man** to set the delay time automatically or manually.

3. Frequency and Interval Setting

When sampling the input signal, the sampling frequency (e.g. 50kHz) or sampling time interval (e.g. 20 μ S) can be specified. The maximum sampling rate can be set to 50KSa/s, with a maximum single acquisition of 2M points and a bandwidth of 10kHz (-3dB).

In most cases, if you specify a digital setting that conflicts with an existing setting, the instrument will display a prompt message and adjust the setting to a legal value. For example, if you configure digitization to achieve a higher sampling rate than the existing integration time (NPLC setting), the instrument will display a prompt message and shorten the integration time.

4. Duration Setting

Set the sampling time or number of readings.

After configuring the parameters, press **Run/Stop** and the digital operation will start when the specified trigger event occurs.

5. Local and remote interaction of data logging and digitize

Attention:

Possible data loss -- During the process of data migration from local to remote, the instrument storage will be cleared: After data is recorded or digitized to storage, if the instrument is accessed remotely (sending SCPI command) and then returned to local, the reading in the storage will be cleared and the instrument will return to "Continue" mode.

For data logging only, you can avoid this situation by recording data to a file instead of memory (see Data Log Mode for more information). If it is for data recording or digitization, you can also avoid this situation by performing operations that can prevent remote access to the instrument. To prevent remote access, you may need to disconnect the LAN, GPIB, and USB interface cables from the instrument before starting the measurement. To prevent remote access through LAN, you can connect to the instrument behind the router to minimize the possibility of remote access.

To view the status of remote data logging or digitize, please use the instrument's web user interface. The web user interface monitor cannot set the instrument to remote.



When accessing remotely, the instrument will continue to perform data logging or digitization until it is completed, and you can retrieve readings remotely.

7.5.3 Trigger Source

Touch **Trg Src** to set the trigger mode to automatic, single, external, or level, as shown in the following figure.

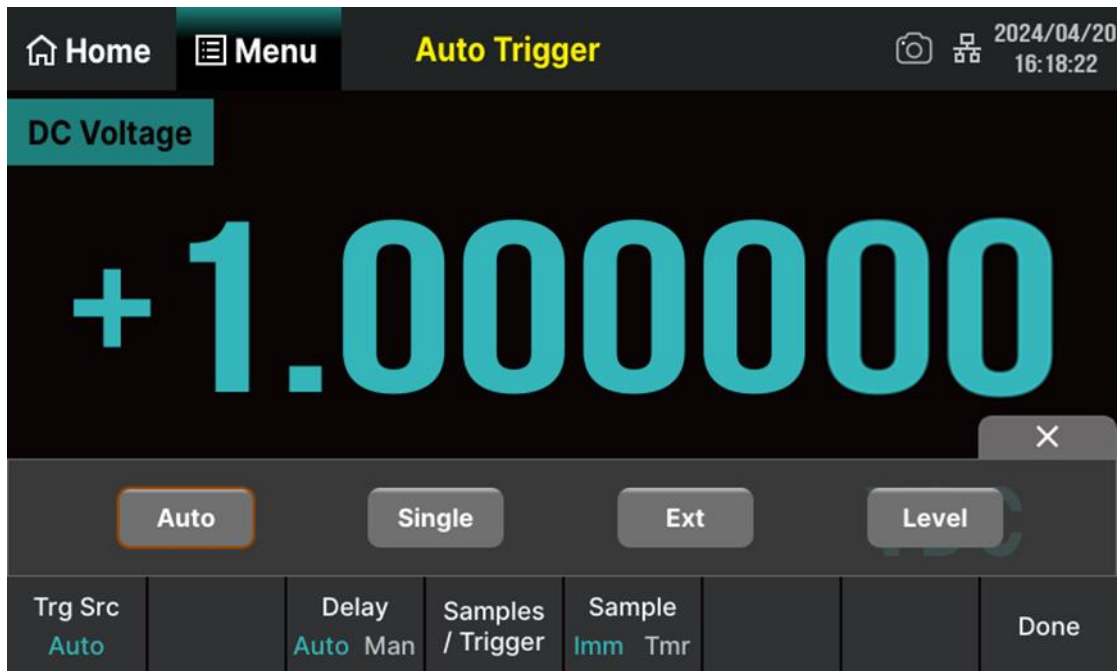

Figure 7-50 Trigger setting interface

7.5.3.1 Trigger Mode

Auto Trigger

The instrument continuously measures, and once a measurement is completed, a new trigger will be automatically triggered, and the multimeter will obtain continuous readings. In Auto trigger mode, "Auto Trigger" is displayed in the upper area of the multimeter display interface. Press **Run/Stop** button to stop triggering, and the interface will display "Stopped" and the last measured value. Press **Run/Stop** button again to resume automatic triggering.

Single Trigger

The instrument will trigger once every time the **Single** button is touched. After reaching the specified number of samples, the multimeter stops measuring. In Single trigger mode, "Single Stopped" is displayed in the upper area of the multimeter display interface.

External Trigger

The multimeter receives the trigger pulse from the Ext Trig interface on the rear panel and triggers at the specified edge of the pulse signal and acquires measured data.

Level Trigger

This mode applies to DCV/DCI/ACI/ACV/2WR/4WR measurement functions. Touch **Level Setting** and enter a desired level using the pop-up virtual keyboard, then touch **Enter** to enable the level. The multimeter will trigger on the positive or negative edge of the input signal when the input level passes through the specified trigger level and acquire measured data. Level trigger mode can specify the time at which sampling begins (based on voltage and slope) trigger.

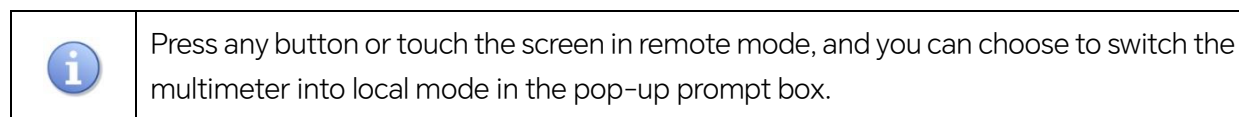

7.5.3.2 Delay

Delay represents the waiting time before sampling begins after receiving the trigger signal.

Touch **Delay** > **Auto** or **Man** to select the delay setting method. When selecting manual mode, enter the desired number of digits using the pop-up virtual keyboard.

7.5.3.3 Set the number of samples

The multimeter will read a specified number of readings each time it receives a trigger signal. Touch **Samples/Trigger** and use the numeric keypad to set the desired number of readings. The range can be set from 1 to 599999999, with a default value of 1.

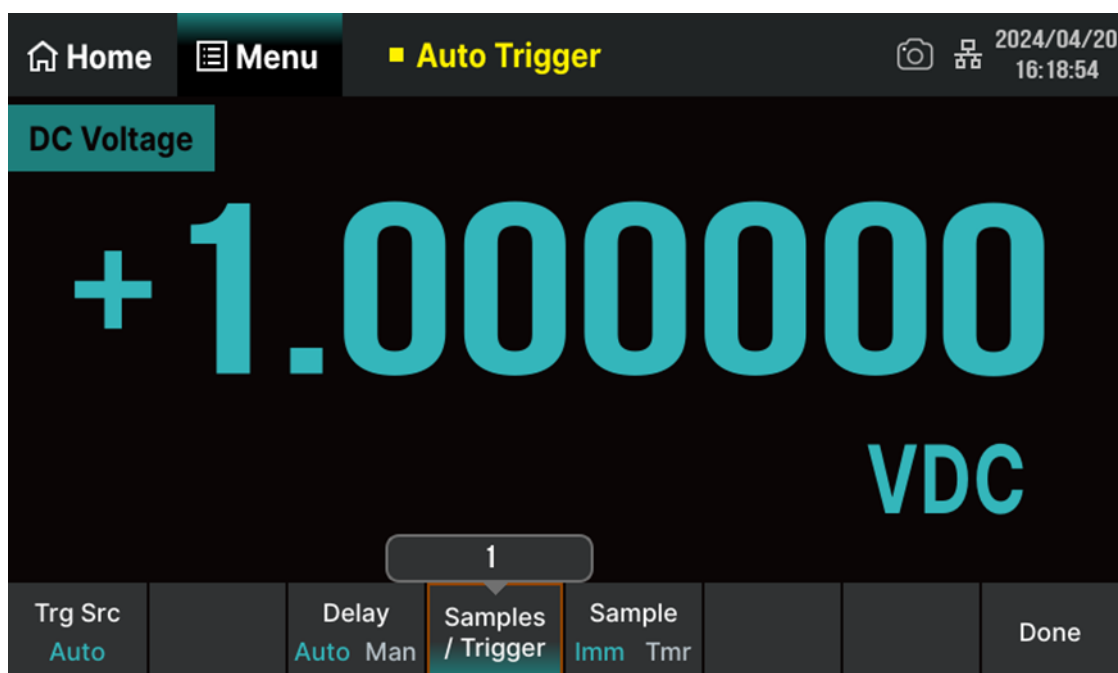

7.5.3.4 Set the Slope

When the trigger source is set to Ext, the option **Slope** will appear in the menu. Select **Neg** or **Pos** to set the external triggering mode to either negative or positive edge triggering.

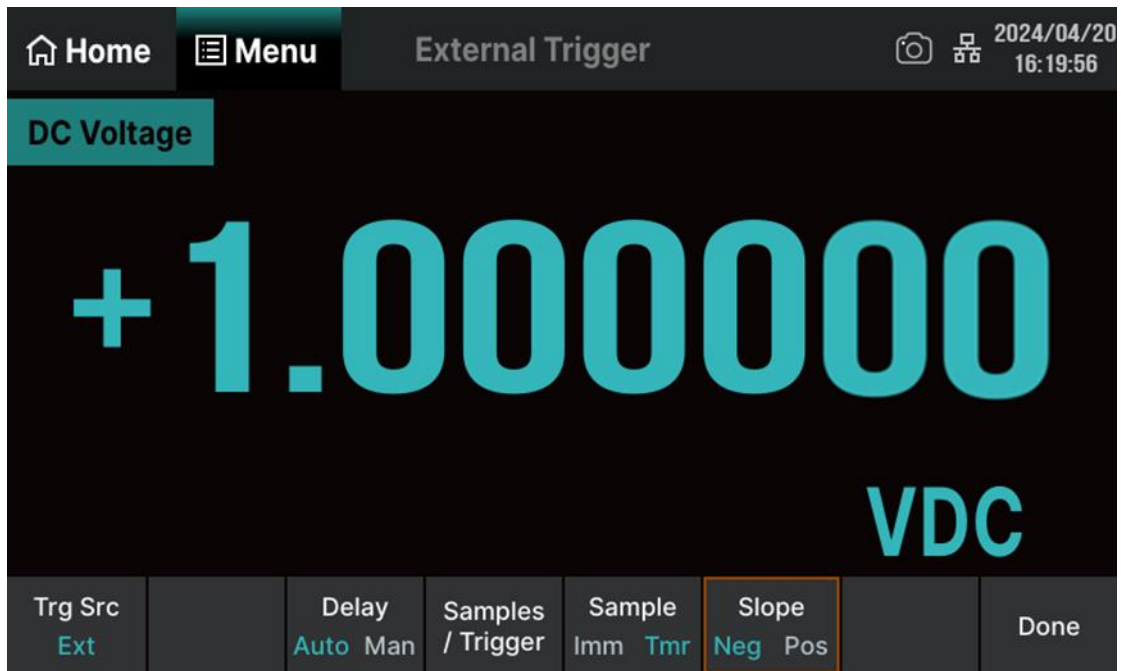

7.5.3.5 Set the Level

When the trigger source is set to Level, the option **Level Setting** will appear in the menu. You can use the numeric keypad to set the desired trigger level value.

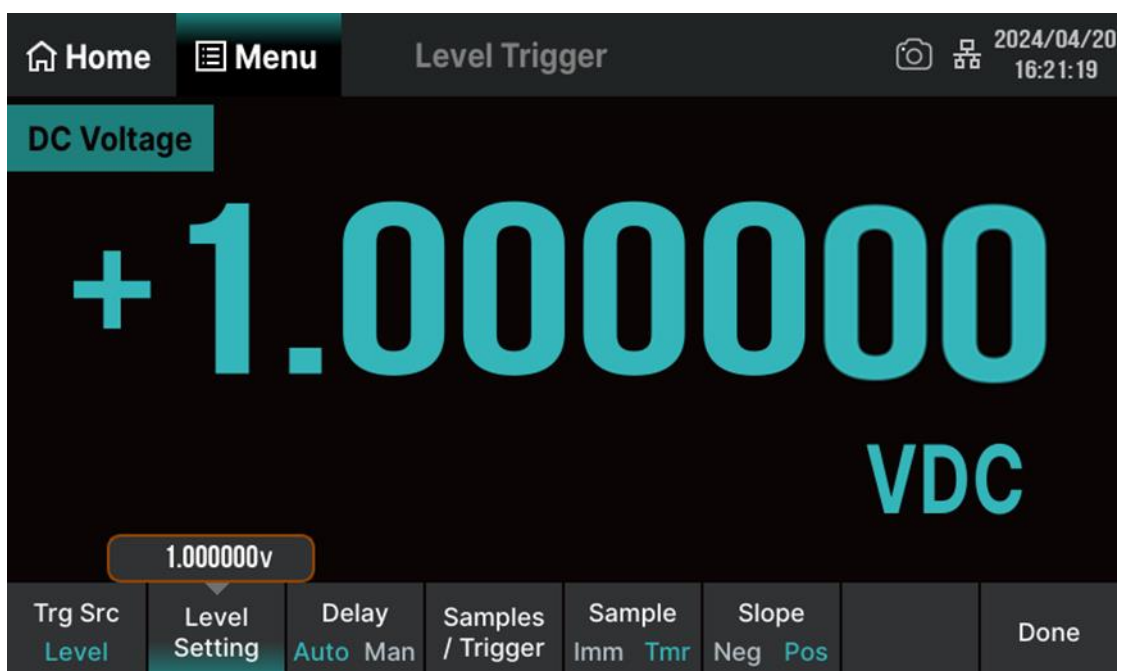

7.5.4 VMC Out

After data collection is completed, the instrument will output a pulse signal through the VM COMP interface on the rear panel. By touching the **VMC Out**, the polarity of the pulse signal can be set to positive or negative.



7.5.5 Save Readings

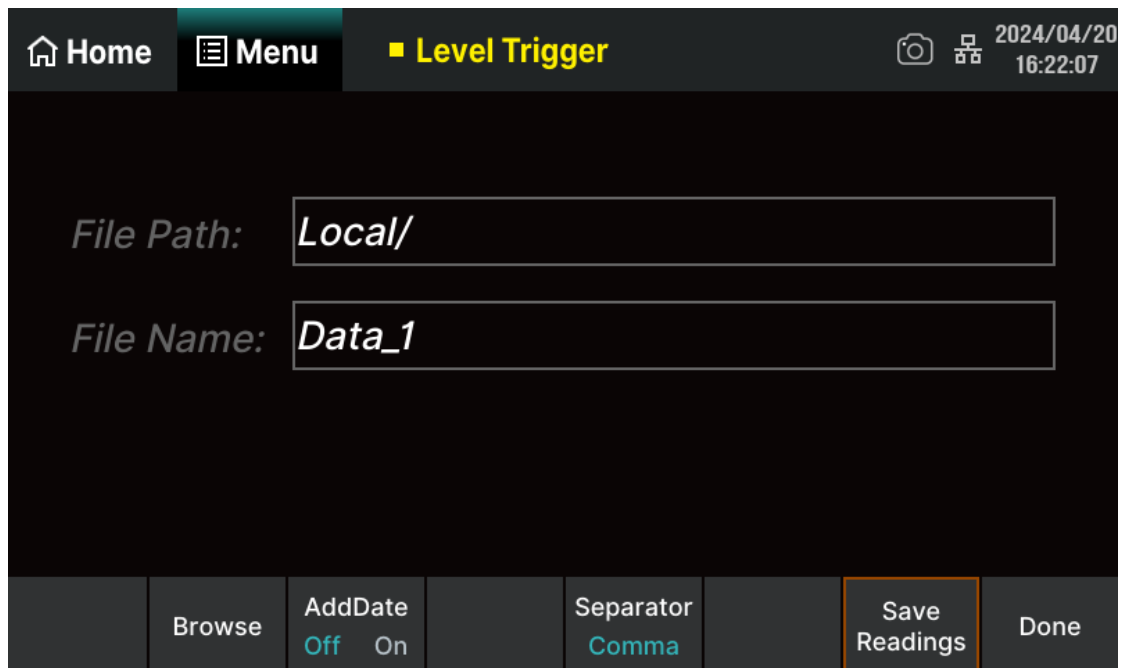

Operating Steps:

1. Select storage path

Touch **Browse** to enter the file manager interface shown in the figure below. You can select the path on the screen, then touch the **Select** button to set the current selected path as the location for file storage and return to the higher-level interface. The "File Path:" column on the interface displays the selected path.

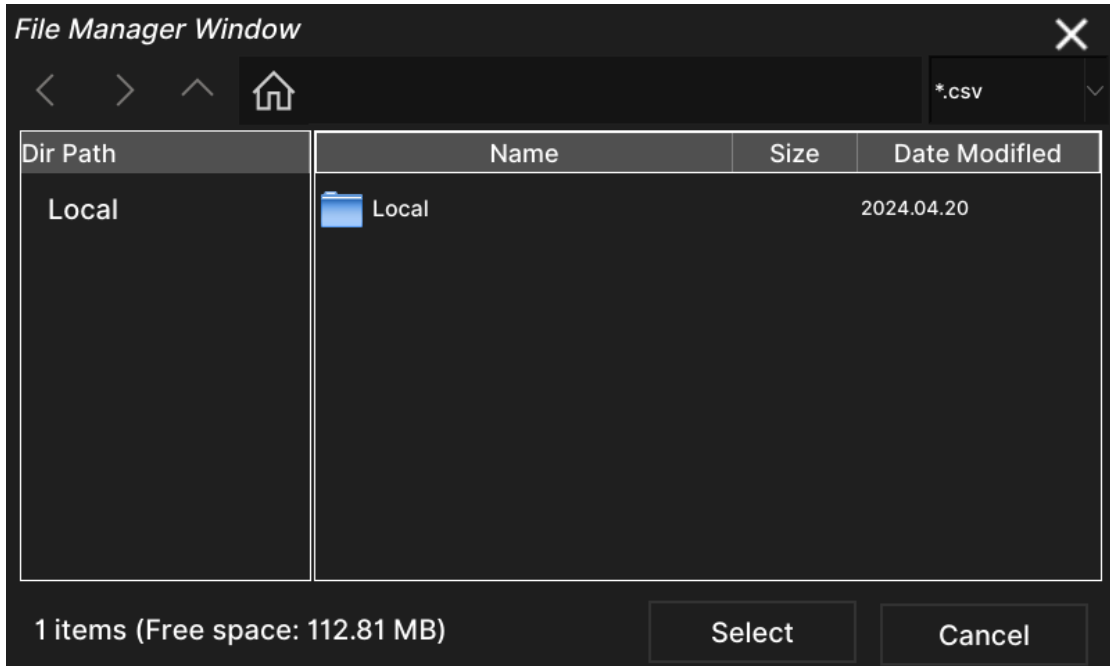

2. Set file name

Touch the "File Name" column on the interface, and you can set the file name in the pop-up virtual keyboard. After entering, touch the **Enter** key to close the virtual keyboard.

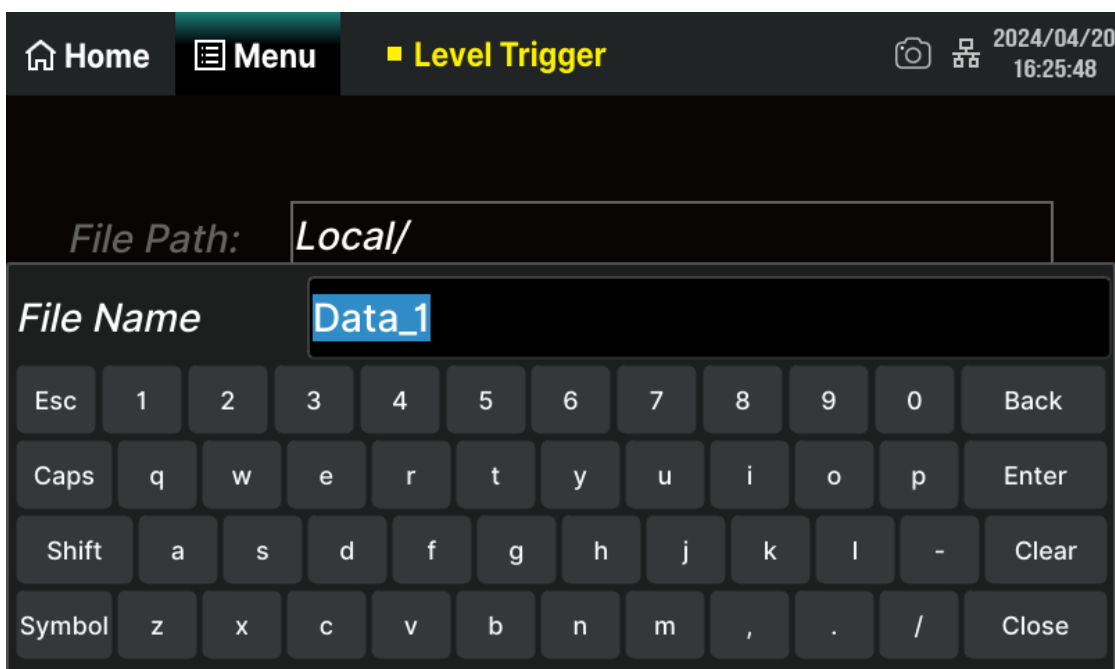

3. Add date

Touch **AddDate** and then select **Off** or **On** . When **On** is selected, the saved file name displays the date the file was saved. When **Off** is selected, the saved file name does not display the date the file was saved.

4. Set Separator

Three types of separators are available: Comma, Tab, and Semicolon.

5. Save Readings

Touch **Save Readings** to save the current reading to the specified path.

7.6 Math Function

The Multimeter provides multiple math functions: Statistics, Limits, dB/dBm and Rel Value. Choose different math functions to meet different measurement demands. Different measurement functions can perform different mathematical operations, please refer to the table below:

Table 7-14 Math function menu description

Measurement Function	Available Math Functions
DCV	Statistics, Limits, dB/dBm, Rel Value
ACV	Statistics, Limits, dB/dBm, Rel Value
DCI	Statistics, Limits, Rel Value
ACI	Statistics, Limits, Rel Value
$\Omega 2W/\Omega 4W$	Statistics, Limits, Rel Value
Cap	Statistics, Limits, Rel Value
Cont	Statistics, Limits
Diode	Statistics, Limits
Freq/Preiod	Statistics, Limits, Rel Value
Sensor	Statistics, Limits, Rel Value

Take the DCV for instance. Perform **Menu** > **Math** to enter the following interface.

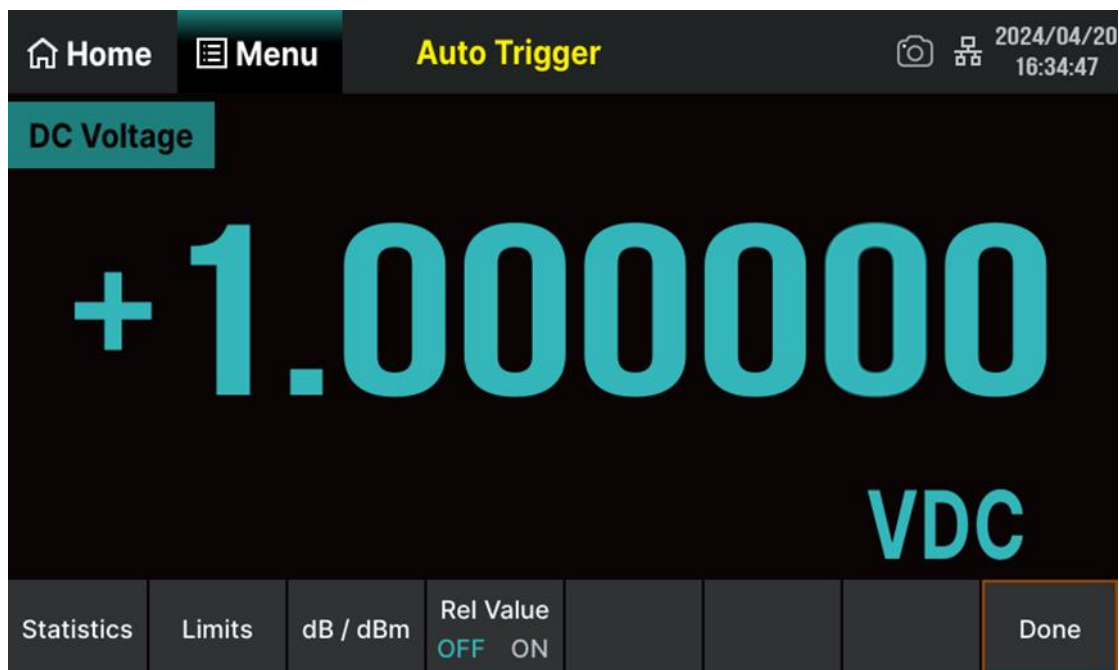



Figure 7-51 Math function menu interface

Table 7-15 Math function menu description

Function Menu	Description
Statistics	Reading statistic functions, including: Max, Min, Average, Span, Std Dev and Samples.
Limits	Execute Pass/Fail tests based on the set upper and lower limit parameters.
dB	The dB measurement is the difference between the input signal and a stored relative value.
dBm	The dBm is based on a calculation of power delivered to a reference resistance, 0 dBm = 1 mW.
Rel Value	Turn on the relative value function and set up the value, or turn off the function.

	<p>Explanations:</p> <ul style="list-style-type: none"> Math function can only be applicable to the main display. If measurement function is changed, all math functions will be closed except Statistics.
---	---

7.6.1 Statistics

There are many kinds of reading statistic functions, including: Max, Min, Average, Span, Std Dev and Samples. Perform **Menu** > **Math** > **Statistic** > **ON** to enter the interface shown below:

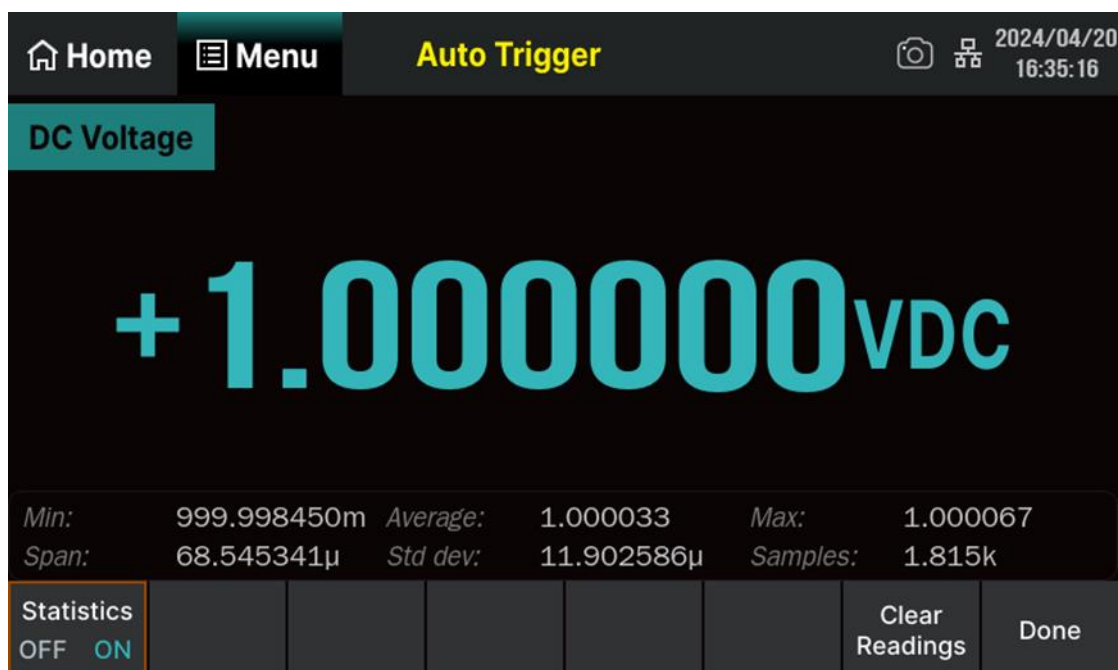

Figure 7-52 Statistics function menu interface

Table 7-16 Statistics function menu description

Function Menu	Setting	Description
Statistics	OFF/ON	Show or hide the statistics function interface.
Clear Readings		Clear all current readings and restart statistics.
Done		Save current settings and return to the higher-level menu.

Table 7-17 Statistics parameters description

Parameters	Description
Min	Show the minimum value of current measurement.
Average	Show the average value of current measurement.
Max	Show the maximum value of current measurement.
Span	Show the span of current measurement.
Std dev	Show the standard deviation value of current measurement.
Samples	Show the maximum value of current measurement.

**Statistics Function:**

- In statistic function, the first reading is usually set to the maximum or minimum value. When getting more readings, current displaying value is always the maximum/minimum reading among all the measured values.
- The maximum, minimum, average and samples values are stored in volatile memory and automatically cleared upon power failure.

7.6.2 Limits

Limits function is available to prompt signals beyond ranges according to the upper and lower parameters. Measurement reading outside the range is displayed in red.

Perform **Menu** > **Math** > **Limits** > **ON** to enter the interface shown below:

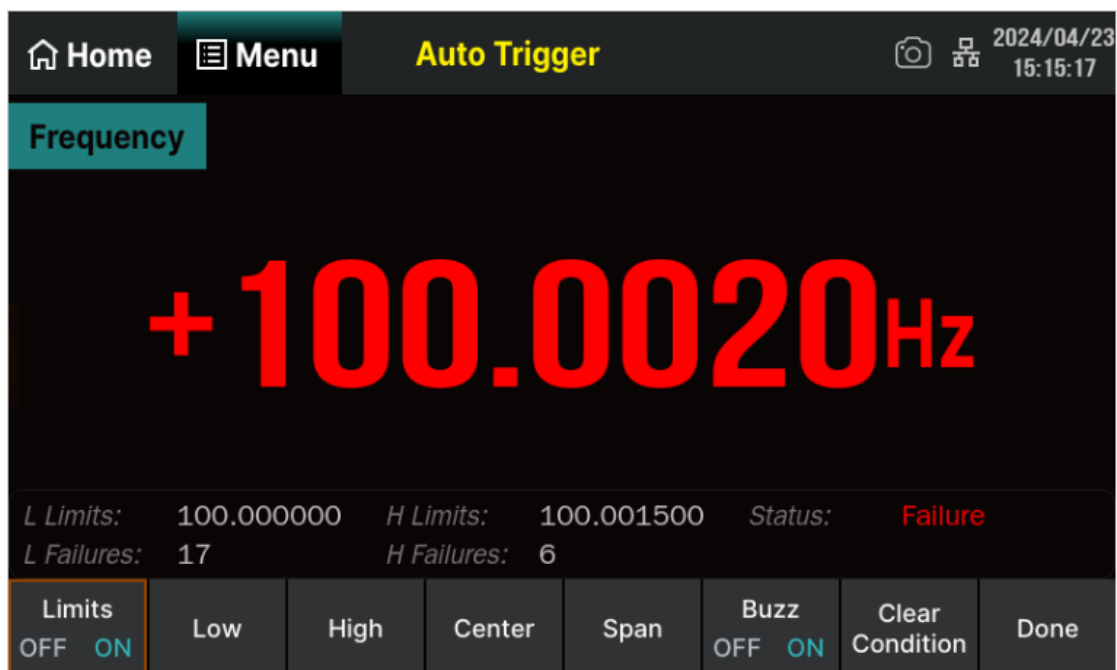

Figure 7-53 Limits function menu interface

Table 7-18 Limits function menu description

Function Menu	Setting	Description
Limits	OFF/ON	Turn on or turn off the Limits function.
Low		Set the desired lower limit.
High		Set the desired upper limit.
Center		Set the desired center value.
Span		Set the desired span.
Buzz	OFF/ON	When the buzzer is on, if the reading is lower or higher than limits, the instrument will beep once.
Clear Condition		Clear all current readings and restart to test.
Done		Save all changes and return to the higher-level menu.

Table 7-19 Limits parameters description

Parameters	Description
L Limits	Lower limit value.
H Limits	Upper limit value.
Status	Status of Limits (Pass/Failure)
L Failures	Show the times that reading is lower than the lower limit.
H Failures	Show the times that reading is higher than the upper limit.

1. Set Limits

Select **Lower** , **High** , **Center** or **Span** and then select the digit you want to edit and enter the numerical value through the pop-up virtual keyboard.

2. Unit

The unit of Limits is decided by the current measurement function.

3. Over hint

- When the reading is lower than the set lower limit, the color of main display will switch blue to red.
- When the reading is higher than the set higher limit, the color of main display will switch blue to red.
- When the reading is lower or higher than the set limits, the Buzzer will buzz once. (The Buzz is turned on.)



The range of Limits function:

- The upper limit value should be always bigger than the lower limit value.
- The upper and lower values are stored in volatile memory. They will be set to default values when the power is on.

7.6.3 dBm

dBm represents the absolute value of the power. The dBm operation calculates the power of the reference resistance according to the measured voltage.

$$\text{dBm} = 10 \times \text{Log}_{10}[(\text{Reading}^2/R_{REF})/0.001\text{W}]$$

Where, Reading is the voltage measurement value, and R_{REF} is the reference resistance

Perform **Menu** > **Math** > **dB/dBm** > **ON** and select the **Mode** as **dBm**, as shown in the following figure.

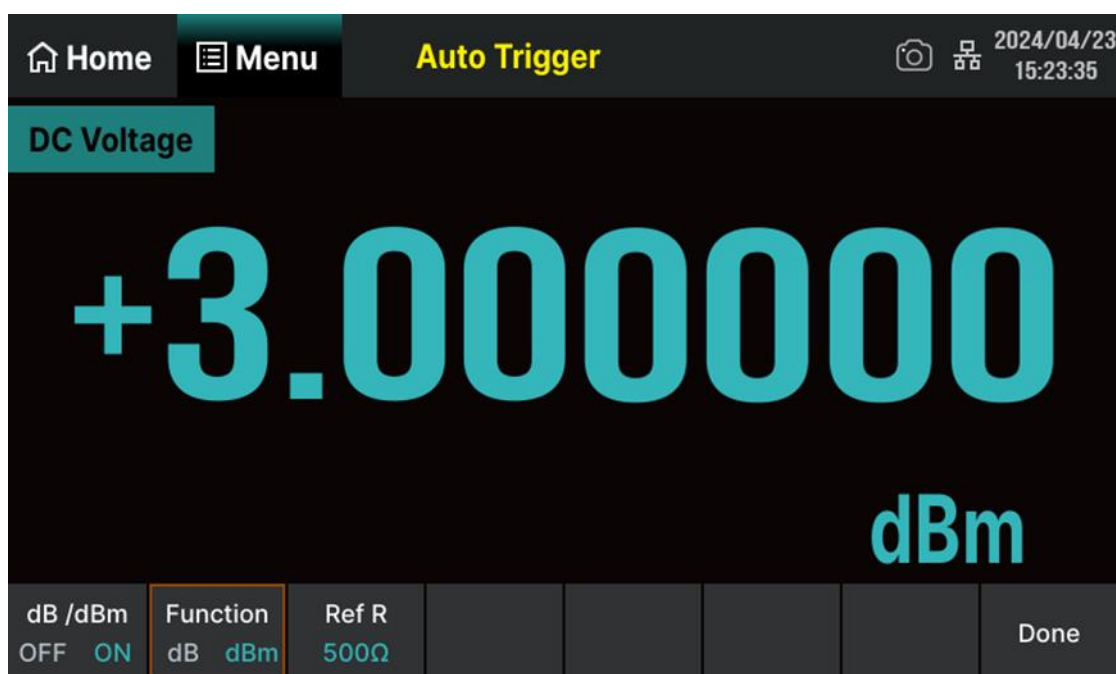

Figure 7-54 dBm function menu interface

Table 7-20 dBm function menu description

Function Menu	Setting	Description
dB/dBm	OFF/ON	Turn on or turn off dB/dBm function.
Function	dB/dBm	Turn on dB or dBm operation, and the selected operation mode will be displayed in the lower right corner of the main display screen.
Ref R		This parameter can be set: 2 Ω~8000 Ω.
Done		Save all changes and return to the higher-level menu.

7.6.4 dB

dB represents the relative value which is used in the relative operation of dBm value. When enabled, the multimeter calculates the dBm value of the next reading and subtracts the preset dB from this value and then displays the result.

$$\text{dB} = 10 \times \text{Log}_{10} \left[\frac{\text{Reading}^2}{\frac{R_{REF}}{0.001\text{W}}} \right] - \text{dB Ref Value}$$

Where, Reading is the voltage measurement value, and R_{REF} is the reference resistance

Perform **Menu** > **Math** > **dB/dBm** > **ON** and select the **Mode** as **dB**, as shown in the following figure.

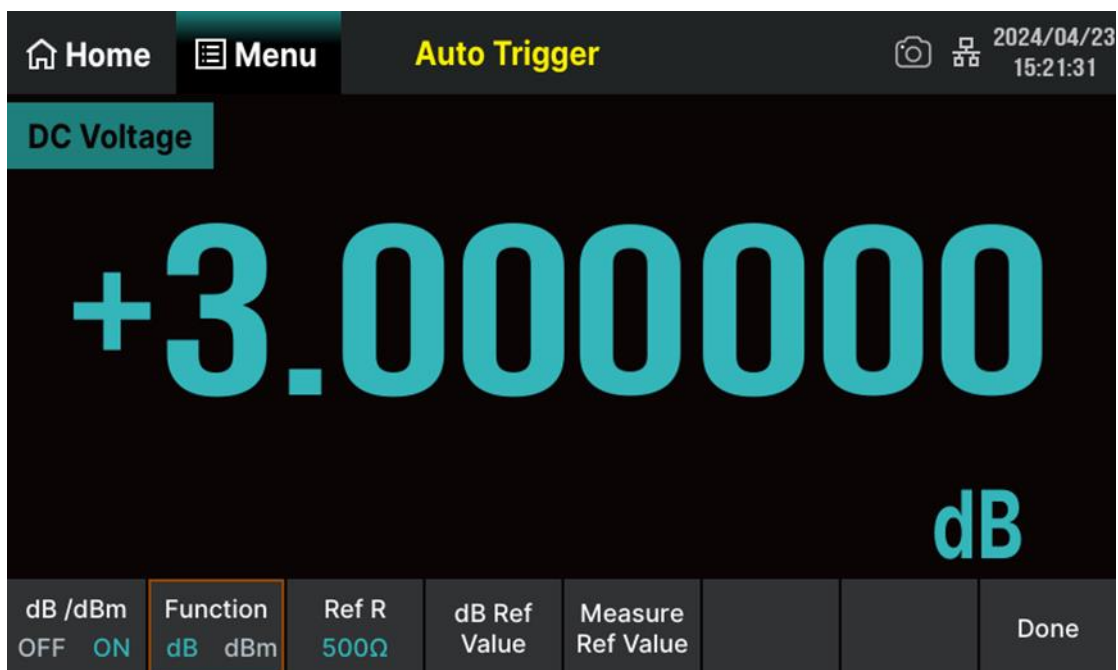



Figure 7-55 dB function menu interface

Table 7-21 dB function menu description

Function Menu	Setting	Description
dB/dBm	OFF/ON	Turn on or turn off dB/dBm function.
Function	dB/dBm	Turn on dB or dBm operation, and the selected operation mode will be displayed in the lower right corner of the main display screen.
Ref R		This parameter can be set to 2 Ω~8000 Ω.
dB Ref Value		Set the referred value of dB.
Measure Ref Value		Set the referred value of measurement.
Done		Save all changes and return to the higher-level menu.

	<p>The range for setting the dB Ref Value is -200 dBm ~+200 dBm, and the default value is 0 dBm.</p> <p>The dB Ref Value can be manually entered as a specified value, or the current measured dBm value can be used as the relative value by touching Measure Relative Value.</p>
---	---

7.6.5 Relative Value

When relative value function is enabled, the displayed reading on the screen is the difference between the actual measured value and the relative value.

$$\text{Reading} = \text{Measured value} - \text{Relative value}$$

There are two ways to configure relative values:

- In the basic measurement interface, set the **Rel Value** status to **ON**, and the multimeter will automatically take the current measurement result as the "relative value".
- Perform **Menu** > **Math** > **Rel Value** > **ON**. then touch **Ref Value Edit**, You can manually input relative values through the pop-up virtual keyboard, and the units are determined by the current measurement function. As shown in the following figure (taking DCV measurement as an example).

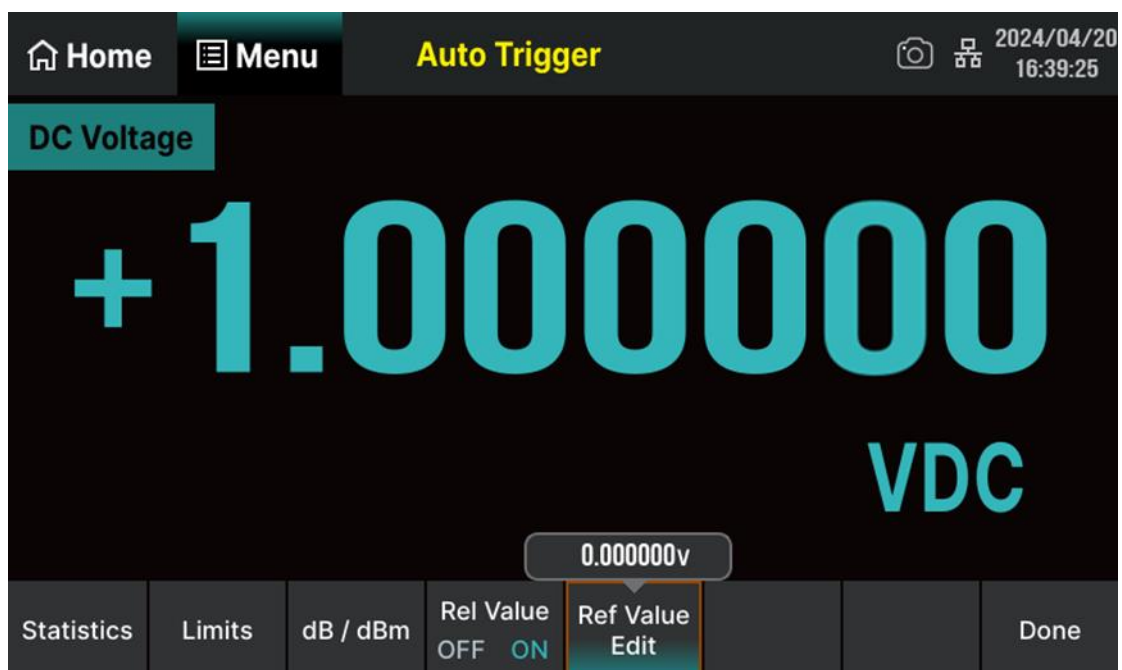

Figure 7-56 Relative value function interface

7.7 Display

7.7.1 Number

Perform **Menu** > **Display** > **Number** to enable the number display function as shown in the following figure. When the multimeter is powered on, the number display mode is enabled by default.

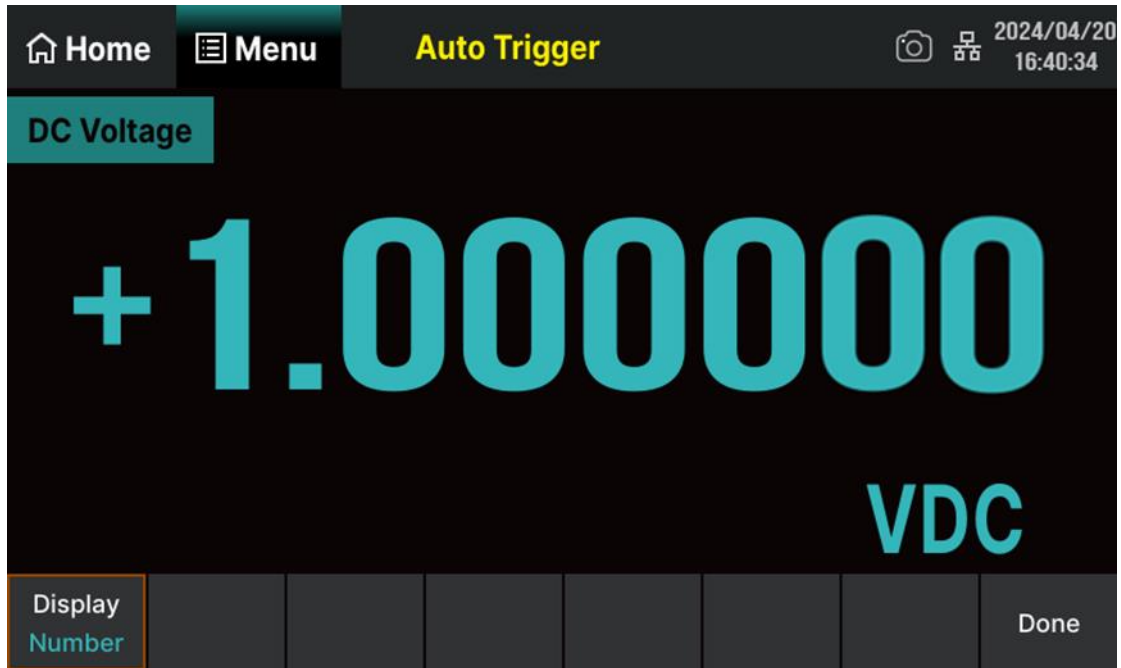

Figure 7-57 Number display interface

7.7.2 Bar

Perform **Menu** > **Display** > **Bar** to enable the bar display function as shown in the following figure.

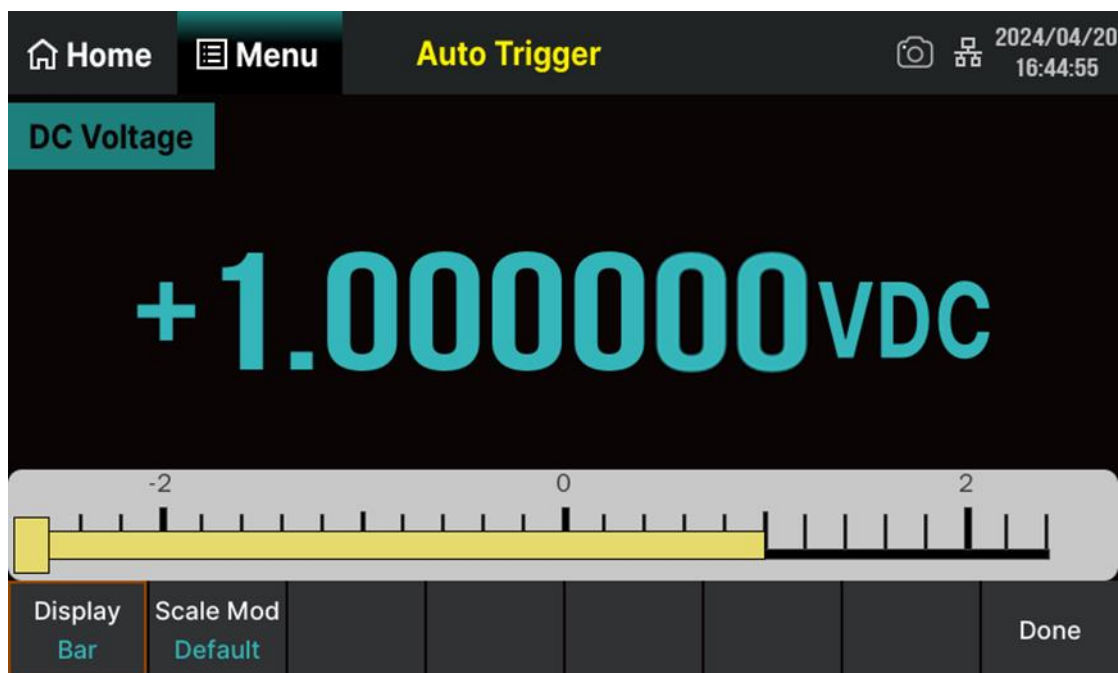

Figure 7-58 Bar display interface

You can choose to set the horizontal scale by default or manually.

- Default: Use the measurement range of the current gear as the scale range of the bar chart.
- Manual: Enter the scale range of the bar chart manually.

Table 7-22 Set the horizontal scale of bar chart manually

Function Menu	Description
Scale Mod	Set the horizontal scale by default or manually.
Scale Low	Set the low value of horizontal scale.
Scale High	Set the high value of horizontal scale.
Scale Center	Set the center value of horizontal scale.
Scale Span	Set the span of horizontal scale.
Done	Save all changes and return to the higher-level menu.

7.7.3 Trend

Perform **Menu** > **Display** > **Trend** to enable the trend display function as shown in the following figure. In continuous measurement mode, the trend chart will display the data trend over a period of time. As shown in the following figure.

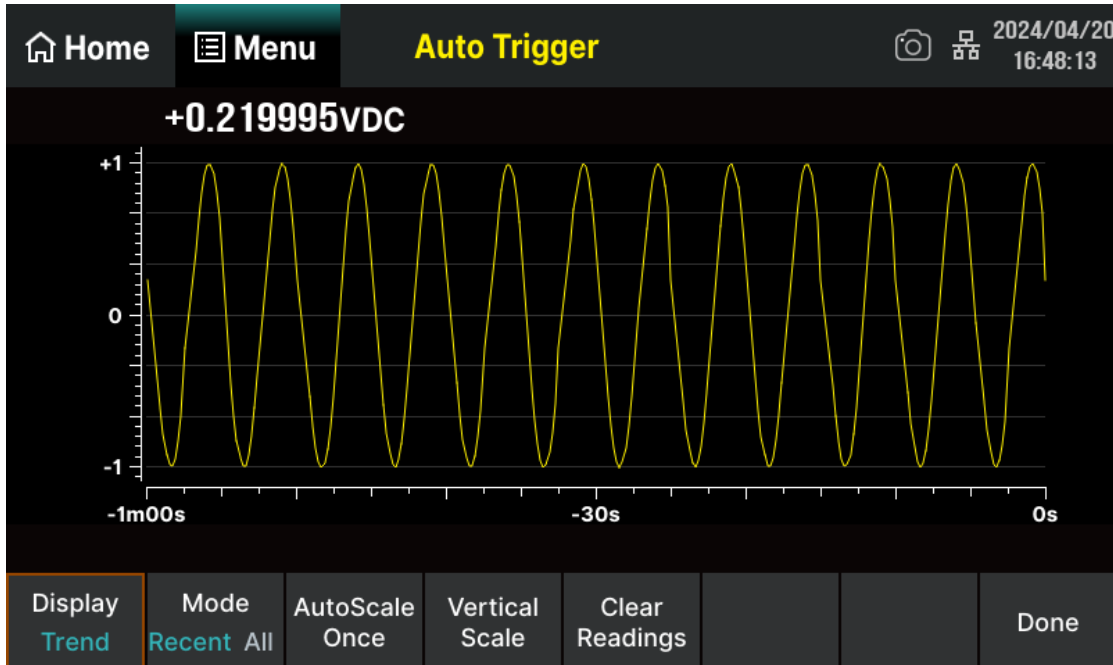

Figure 7-59 Trend display interface

Table 7-23 Trend display function menu description

Function Menu	Setting	Description
Display	Trend	Currently selected display mode is Trend.
Mode	Recent/All	Display the data for the recent or all. You can set the value of Recent by manually.
Autoscale Once		Automatically set the vertical scale once based on existing measurement data.
Vertical Scale		Select the mode for setting the vertical scale.
Clear Readings		Clear all current readings and restart statistics.
Done		Save all changes and return to the higher-level menu.

Vertical range:

You can choose to set the vertical scale by Default, Auto or Manual.

- Default: Use the measurement range of the current gear as the vertical scale range of the trend chart.
- Automatic: Continuously adjust the vertical scale based on the range of existing measurement data.
- Manual: Enter the range of the vertical scale manually.

Table 7-24 Set the vertical scale of trend chart manually

Function Menu	Description
Low	Set the low value of vertical scale.
High	Set the high value of vertical scale.
Center	Set the center value of vertical scale.
Span	Set the span of vertical scale.
Done	Save all changes and return to the higher-level menu.

7.7.4 Histogram

Perform **Menu** > **Display** > **Histogram** to enable the histogram display function as shown in the following figure. Histogram displays the distribution situation of the measurement data.

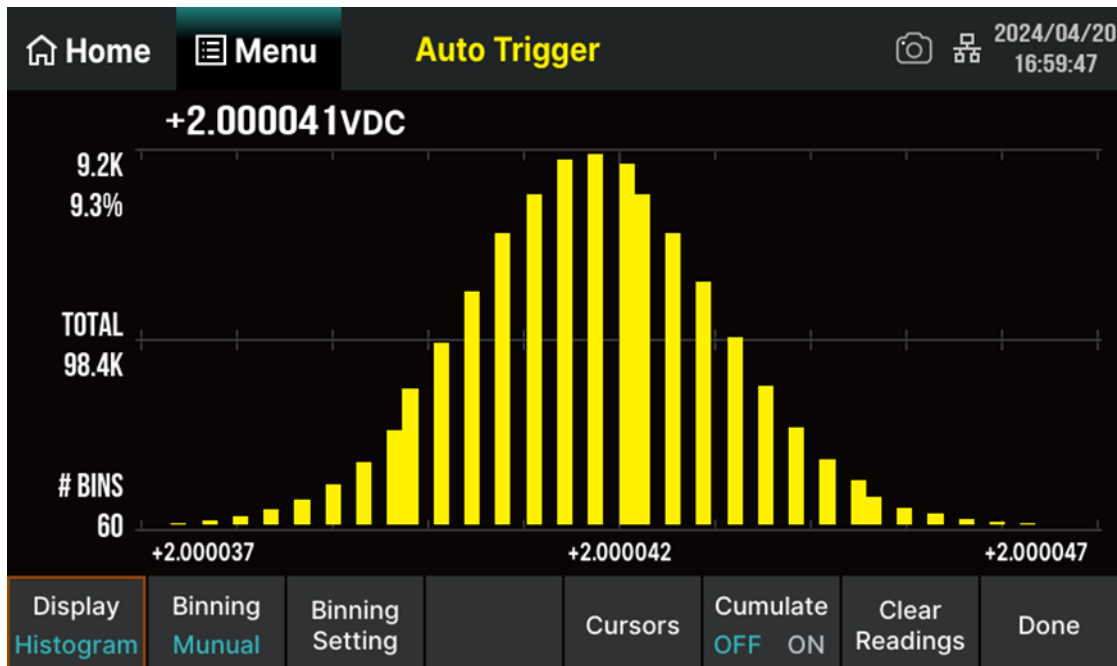

Figure 7-60 Histogram display interface

Description of parameters displayed in the histogram:

Taking the DC voltage measurement in the above figure as an example, describe the various parameters displayed on the interface.

- +2.000041VDC -- Current measured value.
- 9.2K -- Number of samples with the highest bar shape, i.e. the maximum number of samples.
- 9.3% -- Percentage of maximum number of samples to total number of samples.
- Total 98.4 -- Total number of samples
- #BINS 60 -- Total number of columns
- +2.000037, +2.000042, +2.000047 -- The horizontal scale representing the measured value.

Table 7-25 Histogram display function menu description

Function Menu	Setting	Description
Display	Histogram	Currently selected display mode is Hitogram.
Binningg	Auto/Manual	Set the bar processing method to automatic or manual.
Cursor		Display the measurement value of the selected number of binning with the cursor and the percentage with this binning value to the total number of samples, as well as the measurement difference and percentage between the two selected number of binnings.
Cumulate	OFF/ON	Show or hide the cumulative distribution function curve.
Clear Readings		Clear all current readings and restart statistics.

Binning Mode

You can set the binning mode to Auto or Manual.

Auto: Based on the reading, continuously readjust the histogram span, and when the new value exceeds the current span, perform a new columnar processing on the data. The relationship between the number of displayed columns and the number of readings:

Number of Readings	Number of Binnings
0~100	15
101~500	30
501~1000	60

1001~5000	150
5001~10000	300
>10000	600

Manual: Manually set parameters such as the number of columns and horizontal scale range for column processing. After setting the **Binning** to manual, select **Binning Setting** to enter the interface shown in the following figure:

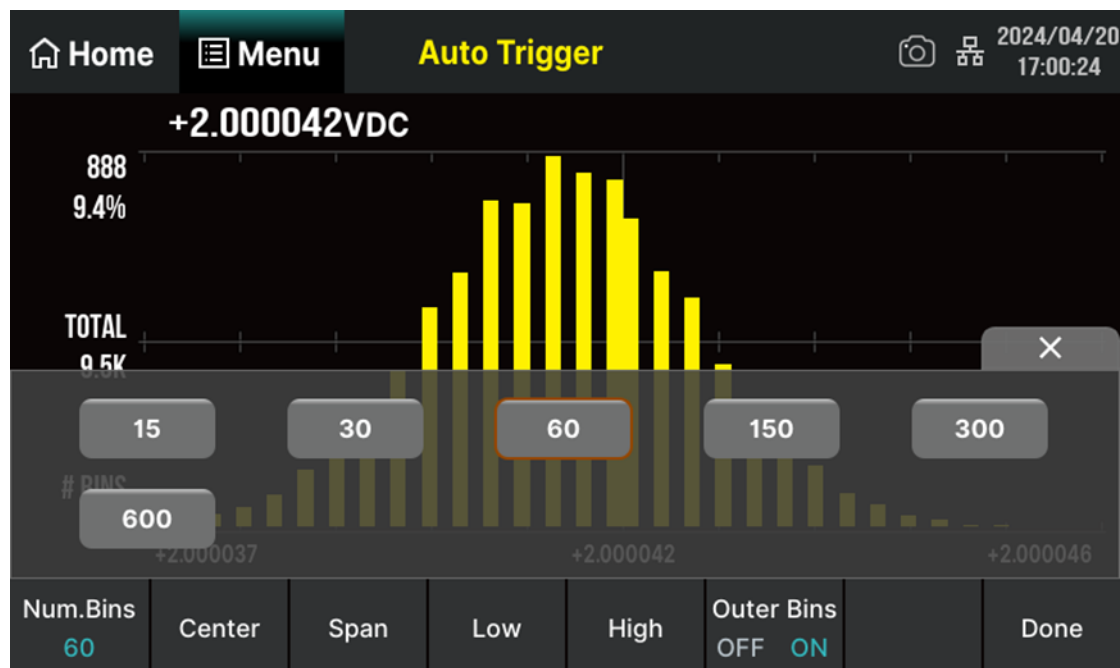

Table 7-26 Grid setting function menu description

Function Menu	Setting	Description
Num. Bins		Set the number of Bins, 10, 20, 40, 100, 200 or 400 selected.
Center		Set the center value of horizontal scale.
Span		Set the span of horizontal scale.
Low		Set the low value of horizontal scale.
High		Set the high value of horizontal scale.
Outer Bins	OFF/ON	Show the bins beyond the scope or not.
Done		Save all changes and return to the higher-level menu.

7.7.5 Probe Hold

After enabling the probe hold function, when the multimeter measures a series of stable readings, the buzzer emits a beep (the buzzer is turned on) and records the measured values on the front panel display. The display can hold up to 8 of the latest measured readings. These readings can be of different measurement types, and you can view or clear the displayed readings.

Perform **Menu** > **Probe Hold** > **ON** to enable the function. As shown in the following figure.

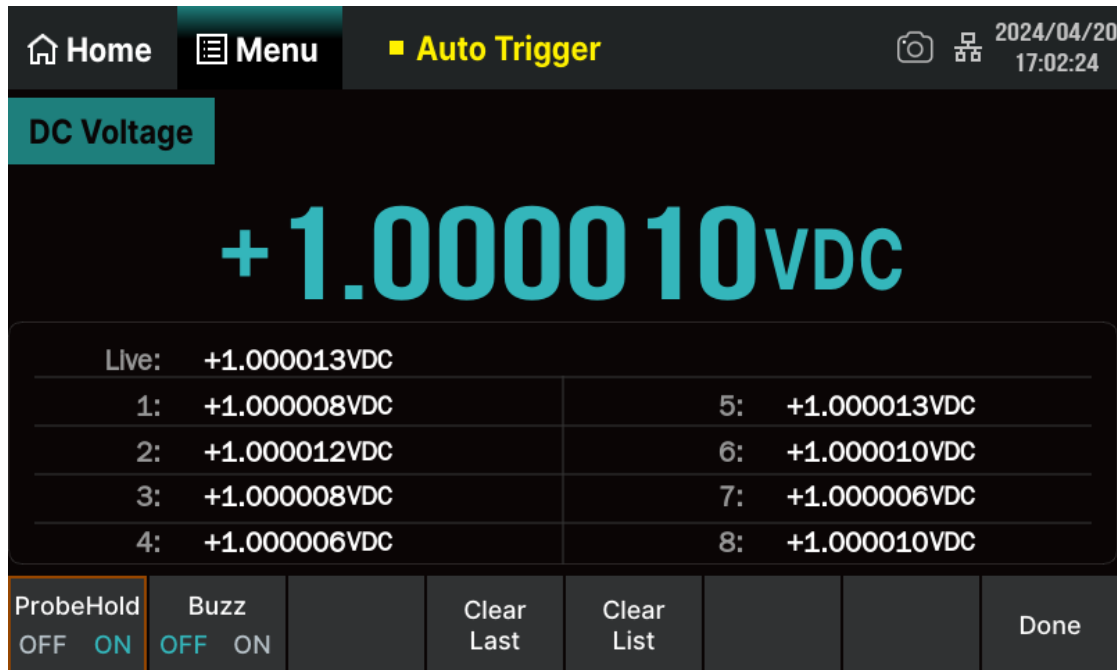

Figure 7-61 Probe Hold function interface

Table 7-27 Probe Hold function menu description

Function Menu	Setting	Description
Probe Hold	OFF/ON	Turn on or off the Probe Hold function.
Buzz	OFF/ON	Turn on or off the buzzer.
Clear Last		Clear the latest stored data from the list.
Clear List		Clear all measured historical data from the list.
Done		Save all changes and return to the higher-level menu.

7.8 Help System

SDM4065A is equipped with a built-in help system. You can get help for every button on the front panel or menu by using the built-in help system, or you can get help about familiar operations in the help system interface.

Perform **Menu** > **Help** to enter help system interface as shown in the following figure.

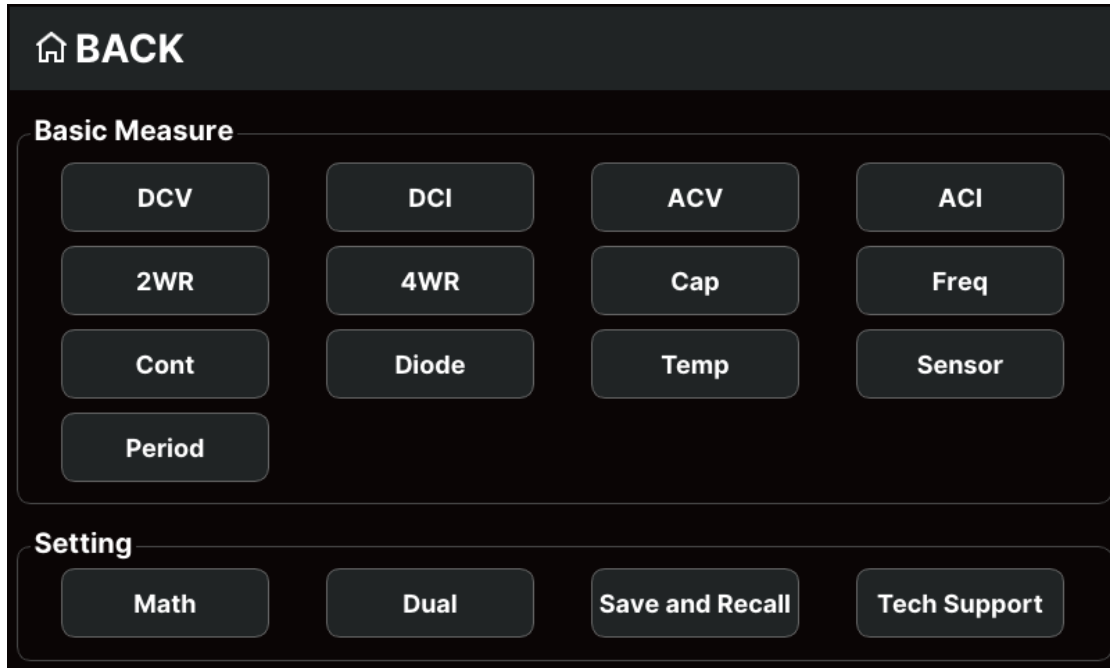

Figure 7-62 Help system interface

1. Basic Measure

Get basic measurement types and methods to connect the leads in different measurements.

2. Math Function

Introduce how to use the math function while you are measuring.

3. Dual-display Function

Get the method to use the dual-display function while you are measuring.

4. Save and Recall

Introduce how to store and recall the data/parameter/ sensors files.

5. Teach support

Get the method to obtain technical support.



In the help system interface, touch the corresponding menu button to view the help information.

8 Measurement Tutorial

8.1 Loading Errors (DC Voltage)

When the resistance of the Device Under Test (DUT) accounts for a significant proportion of the input resistance of the multimeter itself, measurement load errors will occur. The following figure shows the load error source.

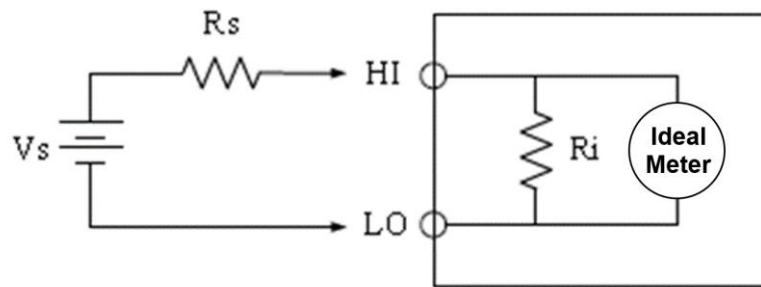

Figure 8-1 Schematic diagram of load error source (DC voltage)

V_s = ideal DUT voltage

R_s = DUT source resistance

R_i = input resistance of the multimeter (10 M Ω or 10 G Ω)

Error (%) = $(100 \times R_s) / (R_s + R_i)$

To reduce the effect of load error and noise interference, the input resistance of the 200 mV, 2 V, and 20 V gears can be set to "10 G Ω ", and the input resistance of the 200 V and 1000 V gears can be fixed to "10 M Ω ".

8.2 True RMS AC Measurement

The AC measurement of SDM4065A has a true RMS response. The average thermal power of a resistor over a period of time is directly proportional to the square of the true RMS of the voltage applied to the resistor during this period, regardless of the waveform. When the energy contained in the voltage or current waveform outside the effective bandwidth of the multimeter can be ignored, SDM4065A can accurately measure the true RMS voltage or current.

The AC voltage and AC current functions measure the “AC coupled” true RMS value, which is to measure the RMS value of the AC component (DC component is rejected) of the input signal. For sine waves, triangle waves, and square waves, the AC and AC+DC values are equal since these waveforms do not contain a DC offset. See the following Table 8-1.

Table 8-1 True RMS AC measurement of sine, triangle and square waves

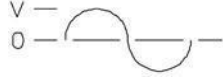
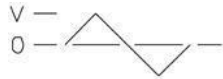
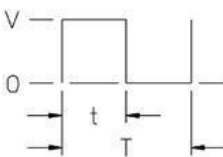
Waveform	Crest Factor (C.F.)	AC RMS	AC+DC RMS
	$\sqrt{2}$	$\frac{V}{\sqrt{2}}$	$\frac{V}{\sqrt{2}}$
	$\sqrt{3}$	$\frac{V}{\sqrt{3}}$	$\frac{V}{\sqrt{3}}$
	$\sqrt{\frac{T}{t}}$	$\frac{V}{C.F.} \times \sqrt{1 - \left(\frac{1}{C.F.}\right)^2}$	$\frac{V}{C.F.}$

Non-symmetrical waveforms, such as pulse trains, contain DC voltages which are rejected by AC coupled true RMS measurements.

An AC coupled true RMS measurement is desirable in situations where you are measuring small AC signals in the presence of DC offsets. For instance, measuring AC ripple present on DC power supplies. There are situations, however, where you might want to know the AC+DC true RMS value. You can determine this value by combining results from DC and AC measurements as the following shows. You should perform the DC measurement using 6.5-digit mode for best AC rejection.

$$RMS_{(AC+DC)} = \sqrt{AC^2 + DC^2}$$

8.3 Crest Factor Errors (Non-sinusoidal Input)

A common misconception is that "since a Multimeter can measure the true RMS of signal, its sine wave accuracy specifications apply to all waveforms.". Actually, the shape of the input signal can dramatically affect measurement accuracy. A common way to describe signal wave shapes is "crest factor". Crest factor is the ratio of the peak value to RMS value of a waveform.

Generally speaking, the greater the crest factor, the greater the energy contained in high frequency harmonics. All Multimeters have errors that are crest factor dependent.

You can estimate the measurement error due to signal crest factor as shown below:

Total Error = Error (Sine wave) + Error (Crest factor) + Error (Bandwidth)

Error (Sine wave): error for sine wave

Error (Crest factor): crest factor additional error

Error (Bandwidth): estimated bandwidth error as shown below:

$$\text{Bandwidth Error} = \frac{-C.F. \times F}{4\pi \times BW} \times 100\%$$

C.F.: signal crest factor

F: fundamental frequency of pulse

BW: effective bandwidth of the Multimeter

Example:

Calculate the approximate measurement error for a pulse train input with a crest factor of 2 and a fundamental frequency of 20 kHz. For this example, assume 1-year accuracy specifications of the Multimeter: $\pm (0.05\% \times \text{reading} + 0.03\% \times \text{range})$.

$$\begin{aligned} \text{Total Error} &= (0.05\% \times \text{reading} + 0.03\% \times \text{range}) + (0.05\% \times \text{range}) + (0.8\% \times \text{reading}) \\ &= 0.85\% \times \text{reading} + 0.08\% \times \text{range} \end{aligned}$$

8.4 Loading Errors (AC Voltage)

In the AC Voltage function, the input of SDM4065A appears as a 1MΩ resistance in parallel with 100pF of capacitance. The test lead that you use to connect signals to the Multimeter will also add additional capacitance and loading. The approximate input resistances of the Multimeter at different frequencies are listed in the following table.

Table 8-2 Approximate input resistances at different frequencies

Input Frequency	Input Resistance
100 Hz	1 MΩ
1 kHz	850 kΩ
10 kHz	160 kΩ
100 kHz	16 kΩ

For low frequencies:

$$\text{Error (\%)} = \frac{-R_s}{R_s + 1M\Omega} \times 100\%$$

For high frequencies:

$$\text{Error (\%)} = \left[\frac{1}{\sqrt{1 + (2\pi \times F \times R_s \times C_m)}} - 1 \right] \times 100\%$$

F: input frequency

R_s: source resistance

C_m: input capacitance (100pF) plus test lead capacitance

9 Troubleshooting

The commonly encountered failures and their solutions are listed below. When you encounter those problems, please solve them following the corresponding steps. If the problem remains still, please contact **SIGLENT** and provide your device information.

1. If the screen is still dark with nothing displayed after pressing the power key.

- 1) Check whether the power cord is well connected.
- 2) Check if the power switch on the front panel is pressed firmly.
- 3) Check whether the power fuse is burned out. If the fuse needs to be changed, please use the specified fuse.
- 4) Restart the instrument after finishing the above inspections.
- 5) If the instrument still can't start up properly, please contact **SIGLENT**.

2. The reading doesn't change when a current signal is input.

- 1) Check whether the test lead is correctly inserted into the HI and LO terminals of current measurement.
- 2) Check whether the DCI or ACI measurement function is enabled.
- 3) Check whether the DCI measurement function is used to measure AC current.

3. The USB storage device cannot be identified.

- 1) Check whether the USB storage device is in good condition.
- 2) Make sure the USB storage device you used is a flash storage device. This instrument does not support hardware storage type.
- 3) Restart the instrument and then insert the USB storage device.
- 4) If the problem persists, please contact **SIGLENT**.

10 Ordering Information

Standard Configuration	Quantity
Power cord	1
Test lead	2
Alligator clip	2
USB cable	1
Quick start	1
Warranty card	1
Upper computer software	Free download from official website

Optional Configuration	Applicable Model
USB-GPIB adapter	USB-GPIB
30 A splitter	SCD30A

	<p>We suggest that the length of USB data wire and LAN cable connected to the instrument should be less than 3m to avoid affecting the product performance.</p> <p>All the accessories are available by contacting your local SIGLENT office.</p>
---	--



About SIGLENT

SIGLENT is an international high-tech company, concentrating on R&D, sales, production and services of electronic test & measurement instruments.

SIGLENT first began developing digital oscilloscopes independently in 2002. After more than a decade of continuous development, SIGLENT has extended its product line to include digital oscilloscopes, isolated handheld oscilloscopes, function/arbitrary waveform generators, RF/MW signal generators, spectrum analyzers, vector network analyzers, digital multimeters, DC power supplies, electronic loads and other general purpose test instrumentation. Since its first oscilloscope was launched in 2005, SIGLENT has become the fastest growing manufacturer of digital oscilloscopes. We firmly believe that today SIGLENT is the best value in electronic test & measurement.

Headquarters:

SIGLENT Technologies Co., Ltd
Add: Bldg No.4 & No.5, Antongda Industrial
Zone, 3rd Liuxian Road, Bao'an District,
Shenzhen, 518101, China
Tel: + 86 755 3688 7876
Fax: + 86 755 3359 1582
Email: sales@siglent.com
Website: int.siglent.com

North America:

SIGLENT Technologies America, Inc
6557 Cochran Rd Solon, Ohio 44139
Tel: 440-398-5800
Toll Free: 877-515-5551
Fax: 440-399-1211
Email: info@siglentna.com
Website: www.siglentna.com

Europe:

SIGLENT Technologies Germany GmbH
Add: Staetzlinger Str. 70
86165 Augsburg, Germany
Tel: +49(0)-821-666 0 111 0
Fax: +49(0)-821-666 0 111 22
Email: info-eu@siglent.com
Website: www.siglenteu.com

Follow us on
Facebook: SiglentTech

